

A HISTORY OF THE EARTH

John Scales Avery

November 6, 2020

Introduction¹

The place of humans in nature

In this book, I have tried to sketch human history, from earliest times until the present, against a cosmic backdrop. According to modern cosmology, the universe is almost unimaginably vast. It is estimated that there are 1,000,000,000,000,000,000,000 stars in the observable universe. Of these, many stars have planets on which life is likely to have developed. Thus our earth and its life forms are by no means unique.

We cannot claim to be “the center of the universe” with any unique justification. However, the earth is our home. It is important to us. As parents, we wish for and work for the survival of our children and grandchildren, and for all future generations of humans. We must also recognize our responsibility as custodians of the natural world. We have a duty to protect both human civilization and the biosphere. We must work with dedication to guard and protect the future of our precious and beautiful earthly home.

Cultural evolution

When humans first appeared on earth, they were not very numerous, and not conspicuously different from other animals. Then suddenly, in a brief space of geological time, they exploded in numbers, populating all parts of the world, and even setting foot on the moon. This explosive growth was driven by what might be called an “information explosion”.

All animals and plants pass on information from one generation to the next in the form of DNA, the information-bearing genetic material. Occasionally, mutations occur, and favorable mutations are preserved while the bearers unfavorable mutations die out. Evolution by this genetic mechanism proceeds very slowly. Humans too, evolve by this slow genetic method, but in addition, they have another method of passing information between generations: cultural evolution.

Cultural evolution depends on the non-genetic storage, transmission, diffusion and utilization of information. The development of human speech, the invention of writing, the development of paper and printing, and finally in

¹This book draws heavily on chapters that I have previously published in various books, but a considerable amount of new material has been added

modern times, mass media, computers and the Internet - all these have been crucial steps in society's explosive accumulation of information and knowledge. Human cultural evolution proceeds at a constantly-accelerating speed, so great in fact that it threatens to shake society to pieces.

Anachronistic human emotions

Today, human greed and folly are destroying the global environment. As if this were not enough, there is a great threat to civilization and the biosphere from an all-destroying thermonuclear war. Both of these severe existential threats are due to faults our inherited emotional nature.

Our emotions have an extremely long evolutionary history. Both lust and rage are emotions that we share with many animals. However, with the rapid advance of human cultural evolution, our ancestors began to live together in progressively larger groups, and in these new societies, our inherited emotional nature was often inappropriate. What once was a survival trait became a sin which needed to be suppressed by morality and law.

Today we live in a world that is entirely different from the one into which our species was born. We face the problems of the 21st century: exploding populations, vanishing resources, and the twin threats of catastrophic climate change and thermonuclear war. We face these severe problems with our poor cave-man's brain, with an emotional nature that has not changed much since our ancestors lived in small tribes, competing for territory on the grasslands of Africa.

Ethics can overwrite tribalism!

After the invention of agriculture, roughly 10,000 years ago, humans began to live in progressively larger groups, which were sometimes multi-ethnic. In order to make towns, cities and finally nations function without excessive injustice and violence, both ethical and legal systems were needed. Today, in an era of global economic interdependence, instantaneous worldwide communication and all-destroying thermonuclear weapons, we urgently need new global ethical principles and a just and enforceable system of international laws.

The very long childhood of humans allows learned behavior to overwrite instinctive behavior. A newborn antelope is able to stand on its feet and follow the herd almost immediately after birth. By contrast, a newborn

human is totally helpless. With cultural evolution, the period of dependence has become progressively longer. Today, advanced education often requires humans to remain dependent on parental or state support until they are in their middle 20's!

Humans are capable of tribalistic inter-group atrocities such as genocides and wars, but they also have a genius for cooperation. Cultural evolution implies inter-group exchange of ideas and techniques. It is a cooperative enterprise in which all humans participate. It is cultural evolution that has given our special dominance. But cultural evolution depends on overwriting destructive tribalism with the principles of law, ethics and politeness. The success of human cultural evolution demonstrates that this is possible. Ethics can overwrite tribalism!

Ethics for the future

In the long run, because of the enormously destructive weapons, which have been produced through the misuse of science, the survival of civilization can only be ensured if we are able to abolish the institution of war. We must also stop destroying our planet through unlimited growth of industry and population.

Besides a humane, democratic and just framework of international law and governance, we urgently need a new global ethic, an ethic where loyalty to family, community and nation will be supplemented by a strong sense of the brotherhood of all humans, regardless of race, religion or nationality. Schiller expressed this feeling in his "Ode to Joy", the text of Beethoven's Ninth Symphony. Hearing Beethoven's music and Schiller's words, most of us experience an emotion of resonance and unity with its message: All humans are brothers and sisters - not just some - all! It is almost a national anthem of humanity. The feelings which the music and words provoke are similar to patriotism, but broader. It is this sense of a universal human family, which we need to cultivate in education, in the mass media, and in religion.

Educational reforms are urgently needed, particularly in the teaching of history. As it is taught today, history is a chronicle of power struggles and war, told from a biased national standpoint. Our own race or religion is superior; our own country is always heroic and in the right.

We urgently need to replace this indoctrination in chauvinism by a reformed view of history, where the slow development of human culture is described, giving adequate credit to all those who have contributed. Our

modern civilization is built on the achievements of ancient cultures. China, India, Mesopotamia, ancient Egypt, Greece, the Islamic world, Christian Europe, and Jewish intellectual traditions all have contributed. Potatoes, corn and squash are gifts from the American Indians. Human culture, gradually built up over thousands of years by the patient work of millions of hands and minds, should be presented to students of history as a precious heritage: far too precious to be risked in a thermonuclear war.

On our small but beautiful earth, made small by technology, made beautiful by nature, there is room for one group only: the family of humankind.

Contents

| | | |
|----------|---|------------|
| 1 | COSMOLOGY | 13 |
| 1.1 | Eratosthenes | 13 |
| 1.2 | Aristarchus | 14 |
| 1.3 | Copernicus | 17 |
| 1.4 | Tycho Brahe | 19 |
| 1.5 | Johannes Kepler | 22 |
| 1.6 | Newton | 26 |
| 1.7 | Albert Einstein | 31 |
| 1.8 | Edwin Hubble | 36 |
| 1.9 | The Big Bang | 39 |
| 1.10 | Timeline of epochs in cosmology | 41 |
| 2 | EARLY HISTORY OF THE EARTH | 57 |
| 2.1 | Formation of the Sun and the Earth | 57 |
| 2.2 | The history of evolutionary theories | 69 |
| 2.3 | Modern theories of the origin of life | 80 |
| 2.4 | Life elsewhere in the universe | 110 |
| 3 | OUR ANCESTORS | 121 |
| 3.1 | Timeline for the evolution of life on the Earth | 121 |
| 3.2 | Early ancestors of humans | 123 |
| 3.3 | Ardipithicus ramidus | 128 |
| 3.4 | Australopithecus | 128 |
| 3.5 | Y-chromosomal DNA and mitochondrial DNA | 133 |
| 3.6 | Exodus: Out of Africa | 137 |
| 4 | AGRICULTURE | 147 |
| 4.1 | Accelerating cultural evolution | 147 |
| 4.2 | Early agriculture in the Middle East | 150 |
| 4.3 | Rice cultivation in Asia | 153 |
| 4.4 | Agriculture in the western hemisphere | 155 |
| 4.5 | Peru gives potatoes to the world | 157 |
| 4.6 | The threat of widespread famine | 160 |

| | | |
|----------|--|------------|
| 4.7 | Population growth and the Green Revolution | 164 |
| 5 | WRITING. PAPER AND PRINTING | 173 |
| 5.1 | Mesopotamia | 173 |
| 5.2 | Egypt | 174 |
| 5.3 | China | 176 |
| 5.4 | The Americas | 177 |
| 5.5 | The invention of paper | 178 |
| 5.6 | Printing | 182 |
| 5.7 | Islamic civilization and printing | 183 |
| 5.8 | Gutenberg | 186 |
| 5.9 | The Enlightenment | 189 |
| 5.10 | Universal education | 201 |
| 6 | AN EXPLOSION OF TECHNOLOGY | 203 |
| 6.1 | Development of the steam engine | 203 |
| 6.2 | Working conditions | 208 |
| 6.3 | The slow acceptance of birth control in England | 212 |
| 6.4 | The Industrial Revolution | 216 |
| 6.5 | Technical change | 217 |
| 6.6 | The Lunar Society | 221 |
| 6.7 | Adam Smith | 223 |
| 6.8 | Colonialism | 229 |
| 6.9 | Trade Unions and minimum wage laws | 230 |
| 6.10 | Rising standards of living | 235 |
| 6.11 | Robber barons and philanthropists | 238 |
| 6.12 | The conflict between capitalism and communism | 242 |
| 6.13 | Globalization | 243 |
| 6.14 | Say's Law | 244 |
| 6.15 | Veblen; economics as anthropology | 244 |
| 6.16 | Gandhi as an economist | 248 |
| 6.17 | Thoreau | 253 |
| 6.18 | The counter-culture | 256 |
| 6.19 | The Brundtland Report | 257 |
| 6.20 | The Earth Summit at Rio | 258 |
| 6.21 | The transition from growth to a steady state - minimizing the trauma . . . | 260 |
| 6.22 | Keynesian economics | 264 |
| 6.23 | The transition to a sustainable economy | 269 |
| 6.24 | Population and goods per capita | 271 |

| | | |
|-----------|--|------------|
| 7 | THE HISTORY OF COMPUTERS | 279 |
| 7.1 | Pascal and Leibniz | 279 |
| 7.2 | Jacquard and Babbage | 281 |
| 7.3 | Harvard's sequence-controlled calculator | 286 |
| 7.4 | The first electronic computers | 287 |
| 7.5 | Biosemiotics | 291 |
| 7.6 | Some personal memories of early computers | 293 |
| 7.7 | The invention of transistors | 295 |
| 7.8 | The Traitorous Eight | 296 |
| 7.9 | Integrated circuits | 298 |
| 7.10 | Moore's law | 299 |
| 7.11 | Automation | 302 |
| 7.12 | Neural networks | 309 |
| 8 | SPACE EXPLORATION | 349 |
| 8.1 | Astronautics | 349 |
| 8.2 | Exploration of the Earth's Moon | 355 |
| 8.3 | Missions to Mars | 358 |
| 8.4 | The Cassini-Huygens space probe | 359 |
| 9 | THE GLOBAL HUMAN FOOTPRINT | 361 |
| 9.1 | How many earths does it take to support us? | 361 |
| 9.2 | Overuse of pesticides and the insect apocalypse | 364 |
| 9.3 | The Silent Spring | 366 |
| 9.4 | Biodiversity loss | 370 |
| 9.5 | Illegal burning for palm oil plantations | 370 |
| 9.6 | Jair Bolsonaro's attack on the Amazon rainforest | 372 |
| 9.7 | Growing populations and forest loss | 376 |
| 9.8 | Desertification and soil erosion | 377 |
| 9.9 | Forest drying and wildfires: a feedback loop | 378 |
| 9.10 | Degraded forests are carbon emitters | 378 |
| 9.11 | Replanting forests | 379 |
| 9.12 | Human ecology | 381 |
| 9.13 | Paul R. Ehrlich and Anne H. Ehrlich | 381 |
| 9.14 | John P. Holdren | 385 |
| 9.15 | The earth is our mother | 389 |
| 10 | STEPS NEEDED FOR POPULATION STABILIZATION | 411 |
| 10.1 | All the needed reforms are desirable in themselves | 411 |
| 10.2 | Higher status and higher education for women | 412 |
| 10.3 | Primary health care for all | 413 |
| 10.4 | Clean water supplies near homes | 415 |
| 10.5 | State provision of care for the elderly | 415 |

| | | |
|-----------|---|------------|
| 10.6 | Abolition of child labor and slavery | 416 |
| 10.7 | General economic progress | 418 |
| 10.8 | Population projections in Africa | 420 |
| 10.9 | What is the future of megacities? | 422 |
| 11 | DISEASE TODAY | 431 |
| 11.1 | Jenner | 431 |
| 11.2 | Pasteur | 434 |
| 11.3 | The germ theory of disease | 436 |
| 11.4 | Vaccines | 439 |
| 11.5 | Rabies | 441 |
| 11.6 | How our immune systems work | 444 |
| 11.7 | Paul Ehrlich, the father of chemotherapy | 445 |
| 11.8 | Mechnikov | 450 |
| 11.9 | Burnet, Jerne and the clonal theory of immunity | 452 |
| 11.10 | Köhler, Milstein and monoclonal antibodies | 457 |
| 11.11 | History of the COVID-19 pandemic | 457 |
| 12 | WAR TODAY | 471 |
| 12.1 | Militarism and money | 471 |
| 12.2 | Ethology | 471 |
| 12.3 | Population genetics | 477 |
| 12.4 | Hope for the future | 479 |
| 12.5 | Religion and ethnic identity | 479 |
| 12.6 | Tribal markings; ethnicity; pseudospeciation | 480 |
| 12.7 | The arms race prior to World War 1 | 489 |
| 12.8 | Krupp, Thyssen and Germany's steel industry | 491 |
| 12.9 | Colonialism and the outbreak of the First World War | 491 |
| 12.10 | Prescott Bush and Hitler | 492 |
| 12.11 | Fritz Thyssen supports Hitler's rise to power | 494 |
| 12.12 | Eisenhower's farewell address | 500 |
| 12.13 | The nuclear arms race | 502 |
| 12.14 | Global famine produced by nuclear war | 508 |
| 12.15 | Military-industrial complexes today | 510 |
| 12.16 | A culture of violence | 518 |
| 12.17 | The threats and costs of war | 521 |
| 12.18 | The threat of nuclear war | 527 |
| 12.19 | Flaws in the concept of nuclear deterrence | 531 |
| 12.20 | Dangers of nuclear power generation | 535 |
| 12.21 | Militarism is the US national religion | 541 |

| | |
|---|------------|
| 13 THE CLIMATE EMERGENCY | 559 |
| 13.1 Contrasting responses to the pandemic and the climate crisis | 559 |
| 13.2 Recovery from the pandemic offers climate action opportunities | 560 |
| 13.3 Quick action is needed to save the long-term future | 560 |
| 13.4 Is the transition to 100% renewable energy possible? | 561 |
| 13.5 Renewables are now much cheaper than fossil fuels! | 564 |
| 13.6 An economic tipping point | 567 |
| 13.7 An unprecedented investment opportunity | 567 |
| 13.8 For creating jobs, renewables beat fossil fuels | 570 |
| 13.9 The Stern Review | 570 |
| 13.10 Major producers of fossil fuels | 574 |
| 13.11 Blood for oil | 576 |
| 13.12 Fossil fuel extraction must stop! | 577 |
| 13.13 Permian-Triassic extinction event | 577 |
| 13.14 Tipping points and feedback loops | 578 |
| 13.15 Greta Thunberg's TED talk | 579 |
| 13.16 Only immediate climate action can save the future | 582 |
| 13.17 Worldwide school strike, 15 March, 2019 | 584 |
| 13.18 Understatement of existential climate risk | 585 |
| 13.19 The 2018 IPCC report | 590 |
| | |
| 14 THE BIRTH OF ETHICS | 603 |
| 14.1 Ethics can overwrite tribalism! | 603 |
| 14.2 The Ten Commandments | 605 |
| 14.3 The life and message of Gautama Buddha | 607 |
| 14.4 Confucius and Chinese civilization | 613 |
| 14.5 Lao Tzu: Unity with nature | 616 |
| 14.6 Socrates and Plato: Dialogues on ethics | 620 |
| 14.7 The ethical message of Greek drama | 623 |
| 14.8 Christian ethics | 624 |
| 14.9 The ethical message of Islam | 633 |
| 14.10 East-West exchanges in Toledo | 638 |
| 14.11 Tolstoy, Gandhi and non-violence | 639 |
| | |
| 15 THE HISTORY OF INTERNATIONAL LAW | 647 |
| 15.1 What is law? | 647 |
| 15.2 Magna Carta, 1215 | 648 |
| 15.3 The English Bill of Rights, 1689 | 650 |
| 15.4 The United States Constitution and Bill of Rights, 1789 | 650 |
| 15.5 Kellogg-Briand Pact, 1928 | 653 |
| 15.6 United Nations Charter, 1945 | 654 |
| 15.7 International Court of Justice, 1946 | 656 |
| 15.8 Nuremberg Principles, 1947 | 657 |

| | | |
|-----------|--|------------|
| 15.9 | The Universal Declaration of Human Rights, 1948 | 658 |
| 15.10 | Geneva Conventions, 1949 | 661 |
| 15.11 | Nuclear Non-Proliferation Treaty, 1968 | 662 |
| 15.12 | Biological Weapons Convention, 1972 | 663 |
| 15.13 | Chemical Weapons Convention, 1997 | 664 |
| 15.14 | Mine Ban Treaty, 1999 | 664 |
| 15.15 | International Criminal Court, 2002 | 665 |
| 15.16 | Arms Trade Treaty, 2013 | 665 |
| 15.17 | Racism, Colonialism and Exceptionalism | 666 |
| 15.18 | The Oslo Principles on Climate Change Obligation, 2015 | 666 |
| 15.19 | Treaty on the Prohibition of Nuclear Weapons, 2017 | 667 |
| 15.20 | Hope for the future, and responsibility for the future | 667 |
| 16 | CONCLUSIONS | 669 |
| 16.1 | Why the earth is important | 669 |
| 16.2 | Cultural evolution | 670 |
| 16.3 | Anachronistic human emotions | 671 |
| 16.4 | Ethics can overwrite tribalism! | 672 |
| 16.5 | The need for international law and governance | 672 |
| 16.6 | Ethics for the future | 674 |

Chapter 1

COSMOLOGY

1.1 Eratosthenes

Eratosthenes (276 B.C. - 196 B.C.), the director of the library at Alexandria, was probably the most cultured man of the Hellenistic Era. His interests and abilities were universal. He was an excellent historian, in fact the first historian who ever attempted to set up an accurate chronology of events. He was also a literary critic, and he wrote a treatise on Greek comedy. He made many contributions to mathematics, including a study of prime numbers and a method for generating primes called the “sieve of Eratosthenes”.

As a geographer, Eratosthenes made a map of the world which, at that time, was the most accurate that had ever been made. The positions of various places on Eratosthenes’ map were calculated from astronomical observations. The latitude was calculated by measuring the angle of the polar star above the horizon, while the longitude probably was calculated from the apparent local time of lunar eclipses.

As an astronomer, Eratosthenes made an extremely accurate measurement of the angle between the axis of the earth and the plane of the sun’s apparent motion; and he also prepared a map of the sky which included the positions of 675 stars.

Eratosthenes’ greatest achievement however, was an astonishingly precise measurement of the radius of the earth. The value which he gave for the radius was within 50 miles of what we now consider to be the correct value! To make this remarkable measurement, Eratosthenes of course assumed that the earth is spherical, and he also assumed that the sun is so far away from the earth that rays of light from the sun, falling on the earth, are almost parallel. He knew that directly south of Alexandria there was a city called Seyne, where at noon on a midsummer day, the sun stands straight overhead. Given these facts, all he had to do to find the radius of the earth was to measure the distance between Alexandria and Seyne. Then, at noon on a midsummer day, he measured the angle which the sun makes with the vertical at Alexandria. From these two values, he calculated the circumference of the earth to be a little over 25,000 miles. This was so much larger than the size of the known world that Eratosthenes concluded (correctly) that most of the earth’s surface must be covered with water; and he stated that “If it were not for the vast extent

of the Atlantic, one might sail from Spain to India along the same parallel.”

1.2 Aristarchus

The Hellenistic astronomers not only measured the size of the earth - they also measured the sizes of the sun and the moon, and their distances from the earth. Among the astronomers who worked on this problem was Aristarchus (c. 320 B.C. - c. 250 B.C.). Like Pythagoras, he was born on the island of Samos, and he may have studied in Athens under Strato. However, he was soon drawn to Alexandria, where the most exciting scientific work of the time was being done.

Aristarchus calculated the size of the moon by noticing the shape of the shadow of the earth thrown on the face of the moon during a solar eclipse. From the shape of the earth's shadow, he concluded that the diameter of the moon is about a third the diameter of the earth. (This is approximately correct).

From the diameter of the moon and the angle between its opposite edges when it is seen from the earth, Aristarchus could calculate the distance of the moon from the earth. Next he compared the distance from the earth to the moon with the distance from the earth to the sun. To do this, he waited for a moment when the moon was exactly half-illuminated. Then the earth, moon and sun formed a right triangle, with the moon at the corner corresponding to the right angle. Aristarchus, standing on the earth, could measure the angle between the moon and the sun. He already knew the distance from the earth to the moon, so now he knew two angles and one side of the right triangle. This was enough to allow him to calculate the other sides, one of which was the sun-earth distance. His value for this distance was not very accurate, because small errors in measuring the angles were magnified in the calculation.

Aristarchus concluded that the sun is about twenty times as distant from the earth as the moon, whereas in fact it is about four hundred times as distant. Still, even the underestimated distance which Aristarchus found convinced him that the sun is enormous! He calculated that the sun has about seven times the diameter of the earth, and three hundred and fifty times the earth's volume. Actually, the sun's diameter is more than a hundred times the diameter of the earth, and its volume exceeds the earth's volume by a factor of more than a million!

Even his underestimated value for the size of the sun was enough to convince Aristarchus that the sun does not move around the earth. It seemed ridiculous to him to imagine the enormous sun circulating in an orbit around the tiny earth. Therefore he proposed a model of the solar system in which the earth and all the planets move in orbits around the sun, which remains motionless at the center; and he proposed the idea that the earth spins about its axis once every day.

Although it was the tremendous size of the sun which suggested this model to Aristarchus, he soon realized that the heliocentric model had many calculational advantages: For example, it made the occasional retrograde motion of certain planets much easier to explain. Unfortunately, he did not work out detailed table for predicting the positions of the plan-

ets. If he had done so, the advantages of the heliocentric model would have been so obvious that it might have been universally adopted almost two thousand years before the time of Copernicus, and the history of science might have been very different.

Aristarchus was completely right, but being right does not always lead to popularity. His views were not accepted by the majority of astronomers, and he was accused of impiety by the philosopher Cleanthes, who urged the authorities to make Aristarchus suffer for his heresy. Fortunately, the age was tolerant and enlightened, and Aristarchus was never brought to trial.

The model of the solar system on which the Hellenistic astronomers finally agreed was not that of Aristarchus but an alternative (and inferior) model developed by Hipparchus (c. 190 B.C. - c. 120 B.C.). Hipparchus made many great contributions to astronomy and mathematics. For example, he was the first person to calculate and publish tables of trigonometric functions. He also invented many instruments for accurate naked-eye observations. He discovered the “precession of equinoxes”, introduced a classification of stars according to their apparent brightness, and made a star-map which far outclassed the earlier star-map of Eratosthenes. Finally, he introduced a model of the solar system which allowed fairly accurate calculation of the future positions of the planets, the sun and the moon.

In English, we use the phrase “wheels within wheels” to describe something excessively complicated. This phrase is derived from the model of the solar system introduced by Hipparchus! In his system, each planet has a large wheel which revolves with uniform speed about the earth (or in some cases, about a point near to the earth). Into this large wheel was set a smaller wheel, called the “epicycle”, which also revolved with uniform speed. A point on the smaller wheel was then supposed to duplicate the motion of the planet. In some cases, the model of Hipparchus needed still more “wheels within wheels” to duplicate the planet’s motion.. The velocities and sizes of the wheels were chosen in such a way as to “save the appearances”.

The model of Hipparchus was popularized by the famous Egyptian astronomer, Claudius Ptolemy (c. 75 A.D. - c. 135 A.D.), in a book which dominated astronomy up to the time of Copernicus. Ptolemy’s book was referred to by its admirers as *Megale Mathematike Syntaxis* (The Great Mathematical Composition). During the dark ages which followed the fall of Rome, Ptolemy’s book was preserved and translated into Arabic by the civilized Moslems, and its name was shortened to *Almagest* (The Greatest). It held the field until, in the 15th century, the brilliant heliocentric model of Aristarchus was rescued from oblivion by Copernicus.



Figure 1.1: A map of the known world by Eratosthenes, surrounded by spheres on which moved the sun, moon and stars.



Figure 1.2: A statue of Aristarchus. In the background we see his sun-centered picture of planetary motion.

1.3 Copernicus

The career of Leonardo da Vinci illustrates the first phase of the “information explosion” which has produced the modern world: Inexpensive paper was being manufactured in Europe, and it formed the medium for Leonardo’s thousands of pages of notes. His notes and sketches would never have been possible if he had been forced to use expensive parchment as a medium. On the other hand, the full force of Leonardo’s genius and diligence was never felt because his notes were not printed.

Copernicus, who was a younger contemporary of Leonardo, had a much greater effect on the history of ideas, because his work was published. Thus, while paper alone made a large contribution to the information explosion, it was printing combined with paper which had an absolutely decisive and revolutionary impact: The modern scientific era began with the introduction of printing.

Nicolas Copernicus (1473-1543) was orphaned at the age of ten, but fortunately for science he was adopted by his uncle, Lucas Watzelrode, the Prince-Bishop of Ermland (a small semi-independent state which is now part of Poland). Through his uncle’s influence, Copernicus was made a Canon of the Cathedral of Frauenberg in Ermland at the age of twenty-three. He had already spent four years at the University of Krakow, but his first act as Canon was to apply for leave of absence to study in Italy.

At that time, Italy was very much the center of European intellectual activity. Copernicus stayed there for ten years, drawing a comfortable salary from his cathedral, and wandering from one Italian University to another. He studied medicine and church law at Padua and Bologna, and was made a Doctor of Law at the University of Ferrara. Thus, thanks to the influence of his uncle, Copernicus had an education which few men of his time could match. He spent altogether fourteen years as a student at various universities, and he experienced the bracing intellectual atmosphere of Italy at the height of the Renaissance.

In 1506, Bishop Lucas recalled Copernicus to Ermland, where the young Canon spent the next six years as his uncle’s personal physician and administrative assistant. After his uncle’s death, Copernicus finally took up his duties as Canon at the cathedral-fortress of Frauenberg on the Baltic coast of Ermland; and he remained there for the rest of his life, administering the estates of the cathedral, acting as a physician to the people of Ermland, and working in secret on his sun-centered cosmology.

Even as a student in Krakow, Copernicus had thought about the problem of removing the defects in the Ptolomeic system. In Italy, where the books of the ancient philosophers had just become available in the original Greek, Copernicus was able to search among their writings for alternative proposals. In Ptolemy’s system, not all the “wheels within wheels” turn with a uniform velocity, although it is possible to find a point of observation called the “*punctum equans*” from which the motion seems to be uniform. Concerning this, Copernicus wrote:

“A system of this sort seems neither sufficiently absolute, nor sufficiently pleasing to the mind... Having become aware of these defects, I often considered whether there could be found a more reasonable arrangement of circles, in which everything would move uniformly



Figure 1.3: **Nicolas Copernicus (1473-1543).**

about its proper center, as the rule of absolute motion requires..”

While trying to remove what he regarded as a defect in the Ptolemeic system by re-arranging the wheels, Copernicus rediscovered the sun-centered cosmology of Aristarchus. However, he took a crucial step which went beyond Aristarchus: What Copernicus did during the thirty-one years which he spent in his isolated outpost on the Baltic was to develop the heliocentric model into a complete system, from which he calculated tables of planetary positions.

The accuracy of Copernicus’ tables was a great improvement on those calculated from the Ptolemeic system, and the motions of the planets followed in a much more natural way. The inner planets, Mercury and Venus, stayed close to the sun because of the smallness of their orbits, while the occasional apparently retrograde motion of the outer planets could be explained in a very natural way by the fact that the more rapidly-moving earth sometimes overtook and passed one of the outer planets. Furthermore, the speed of the planets diminished in a perfectly regular way according to their distances from the sun.

According to the Copernican cosmology, the earth moves around the sun in an orbit whose radius is ninety-three million miles. As the earth moves in its enormous orbit, it is sometimes closer to a particular star, and sometimes farther away. Therefore the observed positions of the stars relative to each other ought to change as the earth moves around its orbit. This effect, called “stellar parallax”, could not be observed with the instruments which were available in the 16th century.

The explanation which Copernicus gave for the absence of stellar parallax was that “Compared to the distance of the fixed stars, the earth’s distance from the sun is negligibly small!” If this is true for the nearest stars, then what about the distance to the farthest stars?

Vast and frightening chasms of infinity seemed to open under the feet of those who understood the implications of the Copernican cosmology. Humans were no longer rulers of a small, tidy universe especially created for themselves. They were suddenly “lost in the

stars”, drifting on a tiny speck of earth through unimaginably vast depths of space. Hence the cry of Blaise Pascal: “*Le silence eternal de ce espaces infinis m’effraie!*”, “The eternal silence of these infinite spaces terrifies me!”

1.4 Tycho Brahe

The next step in the Copernican revolution was taken by two men who presented a striking contrast to one another. Tycho Brahe (1546-1601) was a wealthy and autocratic Danish nobleman, while Johannes Kepler (1571-1630) was a neurotic and poverty-stricken teacher in a provincial German school. Nevertheless, in spite of these differences, the two men collaborated for a time, and Johannes Kepler completed the work of Tycho Brahe.

At the time when Tycho was born, Denmark included southern Sweden; and ships sailing to and from the Baltic had to pay a toll as they passed through the narrow sound between Helsingør (Elsinore) in Denmark, and Helsingborg in what is now Sweden. On each side of the sound was a castle, with guns to control the sea passage. Tycho Brahe’s father, a Danish nobleman, was Governor of Helsingborg Castle. Helsingborg Castle

Tycho’s uncle was also a military man, a Vice-Admiral in the navy of the Danish king, Frederick II. This uncle was childless, and Tycho’s father promised that the Vice-Admiral could adopt one of his own children. By a fortunate coincidence, twins were born to the Governor’s wife. However, when one of the twins died, Tycho’s father was unwilling to part with the survivor (Tycho). The result was that, in the typically high-handed style of the Brahe family, the Vice-Admiral kidnapped Tycho. The Governor at first threatened murder, but soon calmed down and accepted the situation with good grace.

The adoption of Tycho Brahe by his uncle was as fortunate for science as the adoption of Copernicus by Bishop Watzelrode, because the Vice-Admiral soon met his death in an heroic manner which won the particular gratitude of the Danish Royal Family:

Admiral Brahe, returning from a battle against the Swedes, was crossing a bridge in the company of King Frederick II. As the king rode across the bridge, his horse reared suddenly, throwing him into the icy water below. The king would have drowned if Admiral Brahe had not leaped into the water and saved him. However, the Admiral saved the king’s life at the cost of his own. He caught pneumonia and died from it. The king’s gratitude to Admiral Brahe was expressed in the form of special favor shown to his adopted son, Tycho, who had in the meantime become an astronomer (against the wishes of his family).

As a boy of fourteen, Tycho Brahe had witnessed a partial eclipse of the sun, which had been predicted in advance. It struck him as “something divine that men could know the motions of the stars so accurately that they were able a long time beforehand to predict their places and relative positions”. Nothing that his family could say would dissuade him from studying astronomy, and he did so not only at the University of Copenhagen, but also at Leipzig, Wittenberg, Rostock, Basel and Augsburg.

During this period of study, Tycho began collecting astronomical instruments. His lifelong quest for precision in astronomical observation dated from his seventeenth year, when he observed a conjunction of Saturn and Jupiter. He found that the best tables

available were a month in error in predicting this event. Tycho had been greatly struck by the fact that (at least as far as the celestial bodies were concerned), it was possible to predict the future; but here the prediction was in error by a full month! He resolved to do better.

Tycho first became famous among astronomers through his observations on a new star, which suddenly appeared in the sky in 1572. He used the splendid instruments in his collection to show that the new star was very distant from the earth - certainly beyond the sphere of the moon - and that it definitely did not move with respect to the fixed stars. This was, at the time, a very revolutionary conclusion. According to Aristotle, (who was still regarded as the greatest authority on matters of natural philosophy), all generation and decay should be confined to the region beneath the sphere of the moon. Tycho's result meant that Aristotle could be wrong!

Tycho thought of moving to Basel. He was attracted by the beauty of the town, and he wanted to be nearer to the southern centers of culture. However, in 1576 he was summoned to appear before Frederick II. Partly in recognition of Tycho's growing fame as an astronomer, and partly to repay the debt of gratitude which he owed to Admiral Brahe, the king made Tycho the ruler of Hven, an island in the sound between Helsingborg and Helsingør. Furthermore, Frederick granted Tycho generous funds from his treasury to construct an observatory on Hven.

With these copious funds, Tycho Brahe constructed a fantastic castle-observatory which he called Uranienborg. It was equipped not only with the most precise astronomical instruments the world had ever seen, but also with a chemical laboratory, a paper mill, a printing press and a dungeon for imprisoning unruly tenants.

Tycho moved in with a retinue of scientific assistants and servants. The only thing which he lacked was his pet elk. This beast had been transported from the Brahe estate at Knudstrup to Landskrona Castle on the Sound, and it was due to be brought on a boat to the island of Hven. However, during the night, the elk wandered up a stairway in Landskrona Castle and found a large bowl of beer in an unoccupied room. Like its master, the elk was excessively fond of beer, and it drank so much that, returning down the stairway, it fell, broke its leg, and had to be shot.

Tycho ruled his island in a thoroughly autocratic and grandiose style, the effect of which was heightened by his remarkable nose. In his younger days, Tycho had fought a duel with another student over the question of who was the better mathematician. During the duel, the bridge of Tycho's nose had been sliced off. He had replaced the missing piece by an artificial bridge which he had made of gold and silver alloy, and this was held in place by means of a sticky ointment which he always carried with him in a snuff box.

Tycho entertained in the grandest possible manner the stream of scholars who came to Hven to see the wonders of Uranienborg. Among his visitors were King James VI of Scotland (who later ascended the English throne as James I), and the young prince who later became Christian IV of Denmark.

With the help of his numerous assistants, Tycho observed and recorded the positions of the sun, moon, planets and stars with an accuracy entirely unprecedented in the history of astronomy. He corrected both for atmospheric refraction and for instrumental errors,



Figure 1.4: Tycho Brahe. Public domain, Wikimedia Commons



Figure 1.5: **Johannes Kepler**

with the result that his observations were accurate to within two minutes of arc. This corresponds to the absolute limit of what can be achieved without the help of a telescope.

Not only were Tycho's observations made with unprecedented accuracy - they were also made *continuously* over a period of 35 years. Before Tycho's time, astronomers had haphazardly recorded an observation every now and then, but no one had thought of making systematic daily records of the positions of each of the celestial bodies. Tycho was able to make a "motion picture" record of the positions of the planets because he could divide the work among his numerous assistants.

All went well with Tycho on the island of Hven for twelve years. Then, in 1588, Frederick II died (of alcoholism), and his son ascended the throne as Christian IV. Frederick II had been especially grateful to Admiral Brahe for saving his life, and he treated the Admiral's adopted son, Tycho, with great indulgence. However, Christian IV was unwilling to overlook the increasingly scandalous and despotic way in which Tycho was ruling Hven; and he reduced the subsidies which Tycho Brahe had been receiving from the royal treasury. The result was that Tycho, feeling greatly insulted, dismantled his instruments and moved them to Prague, together with his retinue of family, scientific assistants, servants and jester.

In Prague, Tycho became the Imperial Mathematician of the Holy Roman Emperor, Rudolph II. (We should mention in passing that royal patrons such as Rudolph were more interested in astrology than in astronomy: The chief duty of the Imperial Mathematician was to cast horoscopes for the court!) After the move to Prague, one of Tycho's senior scientific assistants became dissatisfied and left. To replace him, Tycho recruited a young German mathematician named Johannes Kepler.

1.5 Johannes Kepler

Two thousand years before the time of Kepler, Pythagoras had dreamed of finding mathematical harmony in the motions of the planets. Kepler and Newton were destined to

fulfil his dream. Kepler was also a true follower of Pythagoras in another sense: Through his devotion to philosophy, he transcended the personal sufferings of a tortured childhood and adolescence. He came from a family of misfits whose neurotic quarrelsomeness was such that Kepler's father narrowly escaped being hanged, and his mother was accused of witchcraft by her neighbors. She was imprisoned, and came close to being burned.

At the age of 4, Kepler almost died of smallpox, and his hands were badly crippled. Concerning his adolescence, Kepler wrote: "I suffered continually from skin ailments, often severe sores, often from the scabs of chronic putrid wounds in my feet, which healed badly and kept breaking out again. On the middle finger of my right hand, I had a worm, and on the left, a huge sore."

Kepler's mental strength compensated for his bodily weakness. His brilliance as a student was quickly recognized, and he was given a scholarship to study theology at the University of Tübingen. He was agonizingly lonely and unpopular among his classmates.

Kepler distinguished himself as a student at Tübingen, and shortly before his graduation, he was offered a post as a teacher of mathematics and astronomy at the Protestant School in Graz. With the post went the title of "Mathematician of the Provenge of Styria". (Graz was the capital of Styria, a province of Austria).

Johannes Kepler was already an ardent follower of Copernicus; and during the summer of his first year in Graz, he began to wonder why the speed of the planets decreased in a regular way according to their distances from the sun, and why the planetary orbits had the particular sizes which Copernicus assigned to them.

On July 9, 1595, in the middle of a lecture which he was giving to his class, Kepler was electrified by an idea which changed the entire course of his life. In fact, the idea was totally wrong, but it struck Kepler with such force that he thought he had solved the riddle of the universe with a single stroke!

Kepler had drawn for his class an equilateral triangle with a circle circumscribed about it, so that the circle passed through all three corners of the triangle. Inside, another circle was inscribed, so that it touched each side of the triangle. It suddenly struck Kepler that the ratio between the sizes of the two circles resembled the ratio between the orbits of Jupiter and Saturn. His mercurial mind immediately leaped from the two-dimensional figure which he had drawn to the five regular solids of Pythagoras and Plato.

In three dimensions, only five different completely symmetrical many-sided figures are possible: the tetrahedron, cube, octahedron, icosahedron and the dodecahedron. There the list stops. As Euclid proved, it is a peculiarity of three-dimensional space that there are only five possible regular polyhedra. These five had been discovered by Pythagoras, and they had been popularized by Plato, the most famous of the Pythagorean philosophers. Because Plato made so much of the five regular solids in his dialogue *Timaeus*, they became known as the "Platonic solids".

In a flash of (completely false) intuition, Kepler saw why there had to be exactly six planets: The six spheres of the planetary orbits were separated by the five Platonic solids! This explained the sizes of the orbits too: Each sphere except the innermost and the outermost was inscribed in one solid and circumscribed about another!

Kepler, who was then twenty-three years old, was carried away with enthusiasm. He

immediately wrote a book about his discovery and called it *Mysterium Cosmographicum*, “The Celestial Mystery”. The book begins with an introduction strongly supporting the Copernican cosmology. After that comes the revelation of Kepler’s marvelous (and false) solution to the cosmic mystery by means of the five Platonic solids. Kepler was unable to make the orbit of Jupiter fit his model, but he explains naively that “nobody will wonder at it, considering the great distance”. The figures for the other planets did not quite fit either, but Kepler believed that the distances given by Copernicus were inaccurate.

Finally, after the mistaken ideas of the book, comes another idea, which comes close to the true picture of gravitation. Kepler tries to solve the problem of why the outer planets move more slowly than the inner ones, and he says:

“If we want to get closer to the truth and establish some correspondence in the proportions, then we must choose between these two assumptions: Either the souls of the planets are less active the farther they are from the sun, or there exists only one moving soul in the center of the orbits, that is the sun, which drives the planets the more vigorously the closer the planet is, but whose force is quasi-exhausted when acting on the outer planets, because of the long distance and the weakening of the force which it entails.”

In *Mysterium Cosmographicum*, Kepler tried to find an exact mathematical relationship between the speeds of the planets and the sizes of their orbits; but he did not succeed in this first attempt. He finally solved this problem many years later, towards the end of his life.

Kepler sent a copy of his book to Tycho Brahe with a letter in which he called Tycho “the prince of mathematicians, not only of our time, but of all time”. Tycho was pleased with this “fan letter”; and he recognized the originality of Kepler’s book, although he had reservations about its main thesis.

Meanwhile, religious hatred had been deepening and Kepler, like all other Protestants, was about to be expelled from Catholic Austria. He appealed to Tycho for help, and Tycho, who was in need of a scientific assistant, wrote to Kepler from the castle of Benatek near Prague:

“You have no doubt already been told that I have most graciously been called here by his Imperial Majesty and that I have been received in a most friendly and benevolent manner. I wish that you would come here, not forced by the adversity of fate, but rather of your own will and desire for common study. But whatever your reason, you will find in me your friend, who will not deny you his advice and help in adversity”

To say that Kepler was glad for this opportunity to work with Tycho Brahe is to put the matter very mildly. The figures of Copernicus did not really fit Kepler’s model, and his great hope was that Tycho’s more accurate observations would give a better fit. In his less manic moments, Kepler also recognized that his model might not be correct after all, but he hoped that Tycho’s data would allow him to find the true solution.

Kepler longed to get his hands on Tycho’s treasure of accurate data, and concerning these he wrote:

“Tycho possesses the best observations, and thus so-to-speak the material for building the new edifice. He also has collaborators, and everything else he could wish for. He only lacks the architect who would put all this to use according to his own design. For although

he has a happy disposition and real architectural skill, he is nevertheless obstructed in his progress by the multitude of the phenomena, and by the fact that the truth is deeply hidden in them. Now old age is creeping upon him, enfeebling his spirit and his forces”

In fact, Tycho had only a short time to live. Kepler arrived in Prague in 1600, and in 1601 he wrote:

“On October 13, Tycho Brahe, in the company of Master Minkowitz, had dinner at the illustrious Rosenborg’s table, and held back his water beyond the demands of courtesy. When he drank more, he felt the tension in his bladder increase, but he put politeness before health. When he got home, he was scarcely able to urinate.. After five sleepless nights, he could still only pass water with the greatest pain, and even so the passage was impeded. The insomnia continued, with internal fever gradually leading to delirium; and the food which he ate, from which he could not be kept, exacerbated the evil... On his last night, he repeated over and over again, like someone composing a poem: ‘Let me not seem to have lived in vain’.”

A few days after Tycho’s death, Kepler was appointed to succeed him as Imperial Mathematician of the Holy Roman Empire. Kepler states that the problem of analyzing Tycho’s data took such a hold on him that he nearly went out of his mind. With a fanatic diligence rarely equaled in the history of science, he covered thousands of pages with calculations. Finally, after many years of struggle and many false starts, he wrung from Tycho’s data three precise laws of planetary motion:

- 1) The orbits of the planets are ellipses, with the sun at one focal point.
- 2) A line drawn from the sun to any one of the planets sweeps out equal areas in equal intervals of time.
- 3) The square of the period of a planet is proportional to the cube of the mean radius of its orbit.

Thanks to Kepler’s struggles, Tycho certainly had not lived in vain. Kepler’s three laws were to become the basis for Newton’s great universal laws of motion and gravitation. Kepler himself imagined a universal gravitational force holding the planets in their orbits around the sun, and he wrote:

“If two stones were placed anywhere in space, near to each other, and outside the reach of force of any other material body, then they would come together after the manner of magnetic bodies, at an intermediate point, each approaching the other in proportion to the other’s mass... ”

“If the earth ceased to attract the waters of the sea, the seas would rise up and flow to the moon... If the attractive force of the moon reaches down to the earth, it follows that the attractive force of the earth, all the more, extends to the moon, and even farther... ”

“Nothing made of earthly substance is absolutely light; but matter which is less dense, either by nature or through heat, is relatively lighter... Out of the definition of lightness follows its motion; for one should not believe that when lifted up it escapes to the periphery of the world, or that it is not attracted to the earth. It is merely less attracted than heavier matter, and is therefore displaced by heavier matter.”

Kepler also understood the correct explanation of the tides. He explained them as being produced primarily by the gravitational attraction of the moon, while being influenced to

a lesser extent by the gravitational field of the sun.

Unfortunately, when Kepler published these revolutionary ideas, he hid them in a tangled jungle of verbiage and fantasy which repelled the most important of his readers, Galileo Galilei. In fact, the English were the first to appreciate Kepler. King James I (whom Tycho entertained on Hven) invited Kepler to move to England, but he declined the invitation. Although the skies of Europe were darkened by the Thirty Years War, Kepler could not bring himself to leave the German cultural background where he had been brought up and where he felt at home.

1.6 Newton

On Christmas day in 1642 (the year in which Galileo died), a recently widowed woman named Hannah Newton gave birth to a premature baby at the manor house of Woolsthorpe, a small village in Lincolnshire, England. Her baby was so small that, as she said later, “he could have been put into a quart mug”, and he was not expected to live. He did live, however, and lived to achieve a great scientific synthesis, uniting the work of Copernicus, Brahe, Kepler, Galileo and Descartes.

When Isaac Newton was four years old, his mother married again and went to live with her new husband, leaving the boy to be cared for by his grandmother. This may have caused Newton to become more solemn and introverted than he might otherwise have been. One of his childhood friends remembered him as “a sober, silent, thinking lad, scarce known to play with the other boys at their silly amusements”.

As a boy, Newton was fond of making mechanical models, but at first he showed no special brilliance as a scholar. He showed even less interest in running the family farm, however; and a relative (who was a fellow of Trinity College) recommended that he be sent to grammar school to prepare for Cambridge University.

When Newton arrived at Cambridge, he found a substitute father in the famous mathematician Isaac Barrow, who was his tutor. Under Barrow’s guidance, and while still a student, Newton showed his mathematical genius by inventing the binomial theorem.

In 1665, Cambridge University was closed because of an outbreak of the plague, and Newton returned for two years to the family farm at Woolsthorpe. He was then twenty-three years old. During the two years of isolation, Newton developed his binomial theorem into the beginnings of differential calculus.

Newton’s famous experiments in optics also date from these years. The sensational experiments of Galileo were very much discussed at the time, and Newton began to think about ways to improve the telescope. Writing about his experiments in optics, Newton says:

“In the year 1666 (at which time I applied myself to the grinding of optic glasses of other figures than spherical), I procured me a triangular prism, to try therewith the celebrated phenomena of colours. And in order thereto having darkened my chamber, and made a small hole in the window shuts to let in a convenient quantity of the sun’s light, I placed my prism at its entrance, that it might thereby be refracted to the opposite wall.”

“It was at first a very pleasing divertisement to view the vivid and intense colours produced thereby; but after a while, applying myself to consider them more circumspectly, I became surprised to see them in an oblong form, which, according to the received laws of refraction I expected should have been circular.”

Newton then describes his crucial experiment. In this experiment, the beam of sunlight from the hole in the window shutters was refracted by two prisms in succession. The first prism spread the light into a rainbow-like band of colors. From this spectrum, he selected a beam of a single color, and allowed the beam to pass through a second prism; but when light of a single color passed through the second prism, the color did not change, nor was the image spread out into a band. No matter what Newton did to it, red light always remained red, once it had been completely separated from the other colors; yellow light remained yellow, green remained green, and blue remained blue.

Newton then measured the amounts by which the beams of various colors were bent by the second prism; and he discovered that red light was bent the least. Next in sequence came orange, yellow, green, blue and finally violet, which was deflected the most. Newton recombined the separated colors, and he found that together, they once again produced white light.

Concluding the description of his experiments, Newton wrote:

“...and so the true cause of the length of the image (formed by the first prism) was detected to be no other than that light is not similar or homogenous, but consists of *deform rays, some of which are more refrangible than others.*”

“As rays of light differ in their degrees of refrangibility, so they also differ in their disposition to exhibit this or that particular colour... To the same degree of refrangibility ever belongs the same colour, and to the same colour ever belongs the same degree of refrangibility.”

“...The species of colour and the degree of refrangibility belonging to any particular sort of rays is not mutable by refraction, nor by reflection from natural bodies, nor by any other cause that I could yet observe. When any one sort of rays hath been well parted from those of other kinds, it hath afterwards obstinately retained its colour, notwithstanding my utmost endeavours to change it.”

During the plague years of 1665 and 1666, Newton also began the work which led to his great laws of motion and universal gravitation. Referring to the year 1666, he wrote:

“I began to think of gravity extending to the orb of the moon; and having found out how to estimate the force with which a globe revolving within a sphere presses the surface of the sphere, from Kepler’s rule of the periodical times of the planets being in a sesquialternate proportion of their distances from the centres of their orbs, I deduced that the forces which keep the planets in their orbs must be reciprocally as the squares of the distances from the centres about which they revolve; and thereby compared the force requisite to keep the moon in her orb with the force of gravity at the surface of the earth, and found them to answer pretty nearly.”

“All this was in the plague years of 1665 and 1666, for in those days I was in the prime of my age for invention, and minded mathematics and philosophy more than at any time since.”

Galileo had studied the motion of projectiles, and Newton was able to build on this work by thinking of the moon as a sort of projectile, dropping towards the earth, but at the same time moving rapidly to the side. The combination of these two motions gives the moon its nearly-circular path.

From Kepler's third law, Newton had deduced that the force with which the sun attracts a planet must fall off as the square of the distance between the planet and the sun. With great boldness, he guessed that this force is *universal*, and that every object in the universe attracts every other object with a gravitational force which is directly proportional to the product of the two masses, and inversely proportional to the square of the distance between them.

Newton also guessed correctly that in attracting an object outside its surface, the earth acts as though its mass were concentrated at its center. However, he could not construct the proof of this theorem, since it depended on integral calculus, which did not exist in 1666. (Newton himself invented integral calculus later in his life.)

In spite of the missing proof, Newton continued and "...compared the force requisite to keep the moon in her orb with the force of gravity at the earth's surface, and found them to answer pretty nearly". He was not satisfied with this incomplete triumph, and he did not show his calculations to anyone. He not only kept his ideas on gravitation to himself, (probably because of the missing proof), but he also refrained for many years from publishing his work on the calculus. By the time Newton published, the calculus had been invented independently by the great German mathematician and philosopher, Gottfried Wilhelm Leibniz (1646-1716); and the result was a bitter quarrel over priority. However, Newton did publish his experiments in optics, and these alone were enough to make him famous.

In 1669, Newton's teacher, Isaac Barrow, generously resigned his post as Lucasian Professor of Mathematics so that Newton could have it. Thus, at the age of 27, Newton became the head of the mathematics department at Cambridge. He was required to give eight lectures a year, but the rest of his time was free for research.

Newton's prism experiments had led him to believe that the only possible way to avoid blurring of colors in the image formed by a telescope was to avoid refraction entirely. Therefore he designed and constructed the first reflecting telescope. In 1672, he presented a reflecting telescope to the newly-formed Royal Society, which then elected him to membership.

Meanwhile, the problems of gravitation and planetary motion were increasingly discussed by the members of the Royal Society. In January, 1684, three members of the Society were gathered in a London coffee house. One of them was Robert Hooke (1635-1703), author of *Micrographia* and Professor of Geometry at Gresham College, a brilliant but irritable man. He had begun his career as Robert Boyle's assistant, and had gone on to do important work in many fields of science. Hooke claimed that he could calculate the motion of the planets by assuming that they were attracted to the sun by a force which diminished as the square of the distance.

Listening to Hooke were Sir Christopher Wren (1632-1723), the designer of St. Paul's Cathedral, and the young astronomer, Edmund Halley (1656-1742). Wren challenged

Hooke to produce his calculations; and he offered to present Hooke with a book worth 40 shillings if he could prove his inverse square force law by means of rigorous mathematics. Hooke tried for several months, but he was unable to win Wren's reward.

Meanwhile, in August, 1684, Halley made a journey to Cambridge to talk with Newton, who was rumored to know very much more about the motions of the planets than he had revealed in his published papers. According to an almost-contemporary account, what happened then was the following:

“Without mentioning his own speculations, or those of Hooke and Wren, he (Halley) at once indicated the object of his visit by asking Newton what would be the curve described by the planets on the supposition that gravity diminished as the square of the distance. Newton immediately answered: an Ellipse. Struck with joy and amazement, Halley asked how he knew it? ‘Why’, replied he, ‘I have calculated it’; and being asked for the calculation, he could not find it, but promised to send it to him.”

Newton soon reconstructed the calculation and sent it to Halley; and Halley, filled with enthusiasm and admiration, urged Newton to write out in detail all of his work on motion and gravitation. Spurred on by Halley's encouragement and enthusiasm, Newton began to put his research in order. He returned to the problems which had occupied him during the plague years, and now his progress was rapid because he had invented integral calculus. This allowed him to prove rigorously that terrestrial gravitation acts as though all the earth's mass were concentrated at its center. Newton also had available an improved value for the radius of the earth, measured by the French astronomer Jean Picard (1620-1682). This time, when he approached the problem of gravitation, everything fell into place.

By the autumn of 1684, Newton was ready to give a series of lectures on dynamics, and he sent the notes for these lectures to Halley in the form of a small booklet entitled *On the Motion of Bodies*. Halley persuaded Newton to develop these notes into a larger book, and with great tact and patience he struggled to keep a controversy from developing between Newton, who was neurotically sensitive, and Hooke, who was claiming his share of recognition in very loud tones, hinting that Newton was guilty of plagiarism.

Newton reacted by striking out from his book every single reference to Robert Hooke. The Royal Society at first offered to pay for the publication costs of Newton's book, but because a fight between Newton and Hooke seemed possible, the Society discretely backed out. Halley then generously offered to pay the publication costs himself, and in 1686 Newton's great book was printed. It is entitled *Philosophiae Naturalis Principia Mathematica*, (The Mathematical Principles of Natural Philosophy), and it is divided into three sections.

The first book sets down the general principles of mechanics. In it, Newton states his three laws of motion, and he also discusses differential and integral calculus (both invented by himself).

In the second book, Newton applies these methods to systems of particles and to hydrodynamics. For example, he calculates the velocity of sound in air from the compressibility and density of air; and he treats a great variety of other problems, such as the problem of calculating how a body moves when its motion is slowed by a resisting medium, such as air or water.

The third book is entitled *The System of the World*. In this book, Newton sets out to

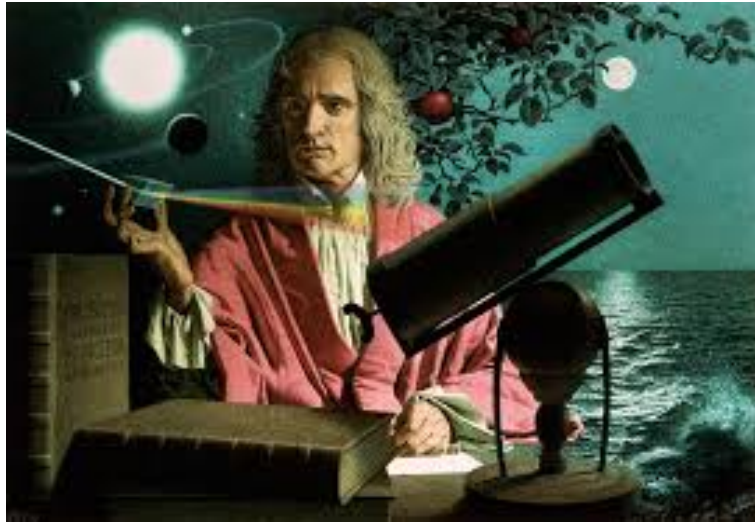

Figure 1.6: Newton: “I do not know what I may appear to the world, but to myself I seem to have been only like a boy playing on the seashore, and diverting myself in now and then finding a smoother pebble or a prettier shell than ordinary, whilst the great ocean of truth lay all undiscovered before me.”

derive the entire behavior of the solar system from his three laws of motion and from his law of universal gravitation. From these, he not only derives all three of Kepler’s laws, but he also calculates the periods of the planets and the periods of their moons; and he explains such details as the flattened, non-spherical shape of the earth, and the slow precession of its axis about a fixed axis in space. Newton also calculated the irregular motion of the moon resulting from the combined attractions of the earth and the sun; and he determined the mass of the moon from the behavior of the tides.

Newton’s *Principia* is generally considered to be one of the greatest scientific works of all time. To present a unified theory explaining such a wide variety of phenomena with so few assumptions was a magnificent and unprecedented achievement; and Newton’s contemporaries immediately recognized the importance of what he had done.

The great Dutch physicist, Christian Huygens (1629-1695), inventor of the pendulum clock and the wave theory of light, travelled to England with the express purpose of meeting Newton. Voltaire, who for reasons of personal safety was forced to spend three years in England, used the time to study Newton’s *Principia*; and when he returned to France, he persuaded his mistress, Madame du Chatelet, to translate the *Principia* into French; and Alexander Pope, expressing the general opinion of his contemporaries, wrote a famous couplet, which he hoped would be carved on Newton’s tombstone:

“Nature and Nature’s law lay hid in night.

God said: ‘Let Newton be!’, and all was light!”

1.7 Albert Einstein

Newton's laws of gravitation and motion stood unchallenged until the 20th century, when Einstein showed that they were only approximately correct. Albert Einstein was born in Ulm, Germany, in 1879. He was the son of middle-class, irreligious Jewish parents, who sent him to a Catholic school. Einstein was slow in learning to speak, and at first his parents feared that he might be retarded; but by the time he was eight, his grandfather could say in a letter: "Dear Albert has been back in school for a week. I just love that boy, because you cannot imagine how good and intelligent he has become."

Remembering his boyhood, Einstein himself later wrote: "When I was 12, a little book dealing with Euclidean plane geometry came into my hands at the beginning of the school year. Here were assertions, as for example the intersection of the altitudes of a triangle in one point, which, though by no means self-evident, could nevertheless be proved with such certainty that any doubt appeared to be out of the question. The lucidity and certainty made an indescribable impression on me."

When Albert Einstein was in his teens, the factory owned by his father and uncle began to encounter hard times. The two Einstein families moved to Italy, leaving Albert alone and miserable in Munich, where he was supposed to finish his course at the gymnasium. Einstein's classmates had given him the nickname "Beidermeier", which means something like "Honest John"; and his tactlessness in criticizing authority soon got him into trouble. In Einstein's words, what happened next was the following: "When I was in the seventh grade at the Lutpold Gymnasium, I was summoned by my home-room teacher, who expressed the wish that I leave the school. To my remark that I had done nothing wrong, he replied only, 'Your mere presence spoils the respect of the class for me'."

Einstein left gymnasium without graduating, and followed his parents to Italy, where he spent a joyous and carefree year. He also decided to change his citizenship. "The over-emphasized military mentality of the German State was alien to me, even as a boy", Einstein wrote later. "When my father moved to Italy, he took steps, at my request, to have me released from German citizenship, because I wanted to be a Swiss citizen."

The financial circumstances of the Einstein family were now precarious, and it was clear that Albert would have to think seriously about a practical career. In 1896, he entered the famous Zürich Polytechnic Institute with the intention of becoming a teacher of mathematics and physics. However, his undisciplined and nonconformist attitudes again got him into trouble. His mathematics professor, Hermann Minkowski (1864-1909), considered Einstein to be a "lazy dog"; and his physics professor, Heinrich Weber, who originally had gone out of his way to help Einstein, said to him in anger and exasperation: "You're a clever fellow, but you have one fault: You won't let anyone tell you a thing! You won't let anyone tell you a thing!"

Einstein missed most of his classes, and read only the subjects which interested him. He was interested most of all in Maxwell's theory of electro-magnetism, a subject which was too "modern" for Weber. There were two major examinations at the Zürich Polytechnic Institute, and Einstein would certainly have failed them had it not been for the help of his

loyal friend, the mathematician Marcel Grossman.

Grossman was an excellent and conscientious student, who attended every class and took meticulous notes. With the help of these notes, Einstein managed to pass his examinations; but because he had alienated Weber and the other professors who could have helped him, he found himself completely unable to get a job. In a letter to Professor F. Ostwald on behalf of his son, Einstein's father wrote: "My son is profoundly unhappy because of his present joblessness; and every day the idea becomes more firmly implanted in his mind that he is a failure, and will not be able to find the way back again."

From this painful situation, Einstein was rescued (again!) by his friend Marcel Grossman, whose influential father obtained for Einstein a position at the Swiss Patent Office: Technical Expert (Third Class). Anchored at last in a safe, though humble, position, Einstein married one of his classmates. He learned to do his work at the Patent Office very efficiently; and he used the remainder of his time on his own calculations, hiding them guiltily in a drawer when footsteps approached.

In 1905, this Technical Expert (Third Class) astonished the world of science with five papers, written within a few weeks of each other, and published in the *Annalen der Physik*. Of these five papers, three were classics: One of these was the paper in which Einstein applied Planck's quantum hypothesis to the photoelectric effect. The second paper discussed "Brownian motion", the zig-zag motion of small particles suspended in a liquid and hit randomly by the molecules of the liquid. This paper supplied a direct proof of the validity of atomic ideas and of Boltzmann's kinetic theory. The third paper was destined to establish Einstein's reputation as one of the greatest physicists of all time. It was entitled "On the Electrodynamics of Moving Bodies", and in this paper, Albert Einstein formulated his special theory of relativity. Essentially, this theory maintained that all of the fundamental laws of nature exhibit a symmetry with respect to rotations in a 4-dimensional space-time continuum.

Gradually, the importance of Einstein's work began to be realized, and he was much sought after. He was first made Assistant Professor at the University of Zürich, then full Professor in Prague, then Professor at the Zürich Polytechnic Institute; and finally, in 1913, Planck and Nernst persuaded Einstein to become Director of Scientific Research at the Kaiser Wilhelm Institute in Berlin. He was at this post when the First World War broke out

While many other German intellectuals produced manifestos justifying Germany's invasion of Belgium, Einstein dared to write and sign an anti-war manifesto. Einstein's manifesto appealed for cooperation and understanding among the scholars of Europe for the sake of the future; and it proposed the eventual establishment of a League of Europeans. During the war, Einstein remained in Berlin, doing whatever he could for the cause of peace, burying himself unhappily in his work, and trying to forget the agony of Europe, whose civilization was dying in a rain of shells, machine-gun bullets, and poison gas.

The work into which Einstein threw himself during this period was an extension of his theory of relativity. He already had modified Newton's equations of motion so that they exhibited the space-time symmetry required by his Principle of Special Relativity. However, Newton's law of gravitation. remained a problem.

Obviously it had to be modified, since it disagreed with his Special Theory of Relativity; but how should it be changed? What principles could Einstein use in his search for a more correct law of gravitation? Certainly whatever new law he found would have to give results very close to Newton's law, since Newton's theory could predict the motions of the planets with almost perfect accuracy. This was the deep problem with which he struggled.

In 1907, Einstein had found one of the principles which was to guide him, the Principle of Equivalence of inertial and gravitational mass. After turning Newton's theory over and over in his mind, Einstein realized that Newton had used mass in two distinct ways: His laws of motion stated that the force acting on a body is equal to the mass of the body multiplied by its acceleration; but according to Newton, the gravitational force on a body is also proportional to its mass. In Newton's theory, gravitational mass, by a coincidence, is equal to inertial mass; and this holds for all bodies. Einstein decided to construct a theory in which gravitational and inertial mass necessarily have to be the same.

He then imagined an experimenter inside a box, unable to see anything outside it. If the box is on the surface of the earth, the person inside it will feel the pull of the earth's gravitational field. If the experimenter drops an object, it will fall to the floor with an acceleration of 32 feet per second per second. Now suppose that the box is taken out into empty space, far away from strong gravitational fields, and accelerated by exactly 32 feet per second per second. Will the enclosed experimenter be able to tell the difference between these two situations? Certainly no difference can be detected by dropping an object, since in the accelerated box, the object will fall to the floor in exactly the same way as before.

With this "thought experiment" in mind, Einstein formulated a general Principle of Equivalence: He asserted that no experiment whatever can tell an observer enclosed in a small box whether the box is being accelerated, or whether it is in a gravitational field. According to this principle, gravitation and acceleration are locally equivalent, or, to say the same thing in different words, gravitational mass and inertial mass are equivalent.

Einstein soon realized that his Principle of Equivalence implied that a ray of light must be bent by a gravitational field. This conclusion followed because, to an observer in an accelerated frame, a light beam which would appear straight to a stationary observer, must necessarily appear very slightly curved. If the Principle of Equivalence held, then the same slight bending of the light ray would be observed by an experimenter in a stationary frame in a gravitational field.

Another consequence of the Principle of Equivalence was that a light wave propagating upwards in a gravitational field should be very slightly shifted to the red. This followed because in an accelerated frame, the wave crests would be slightly farther apart than they normally would be, and the same must then be true for a stationary frame in a gravitational field. It seemed to Einstein that it ought to be possible to test experimentally both the gravitational bending of a light ray and the gravitational red shift.

This seemed promising; but how was Einstein to proceed from the Principle of Equivalence to a formulation of the law of gravitation? Perhaps the theory ought to be modeled after Maxwell's electromagnetic theory, which was a field theory, rather than an "action at a distance" theory. Part of the trouble with Newton's law of gravitation was that it allowed a signal to be propagated instantaneously, contrary to the Principle of Special Relativity.

A field theory of gravitation might cure this defect, but how was Einstein to find such a theory? There seemed to be no way.

From these troubles Albert Einstein was rescued (a third time!) by his staunch friend Marcel Grossman. By this time, Grossman had become a professor of mathematics in Zürich, after having written a doctoral dissertation on tensor analysis and non-Euclidean geometry, the very things that Einstein needed. The year was then 1912, and Einstein had just returned to Zürich as Professor of Physics at the Polytechnic Institute. For two years, Einstein and Grossman worked together; and by the time Einstein left for Berlin in 1914, the way was clear. With Grossman's help, Einstein saw that the gravitational field could be expressed as a curvature of the 4-dimensional space-time continuum.

In 1919, a British expedition, headed by Sir Arthur Eddington, sailed to a small island off the coast of West Africa. Their purpose was to test Einstein's prediction of the bending of light in a gravitational field by observing stars close to the sun during a total eclipse. The observed bending agreed exactly with Einstein's predictions; and as a result he became world-famous. The general public was fascinated by relativity, in spite of the abstruseness of the theory (or perhaps because of it). Einstein, the absent-minded professor, with long, uncombed hair, became a symbol of science. The world was tired of war, and wanted something else to think about.

In its original version, Einstein's theory of relativity predicted an expansion of the universe. However, since the universe was then thought to be static, Einstein later added to his equations a "cosmological constant" that led to a static non-expanding universe. Later, in 1929, when the discoveries of Edwin Hubble showed that the universe is indeed expanding, Einstein said that he considered his cosmological constant to be the biggest blunder of his life.

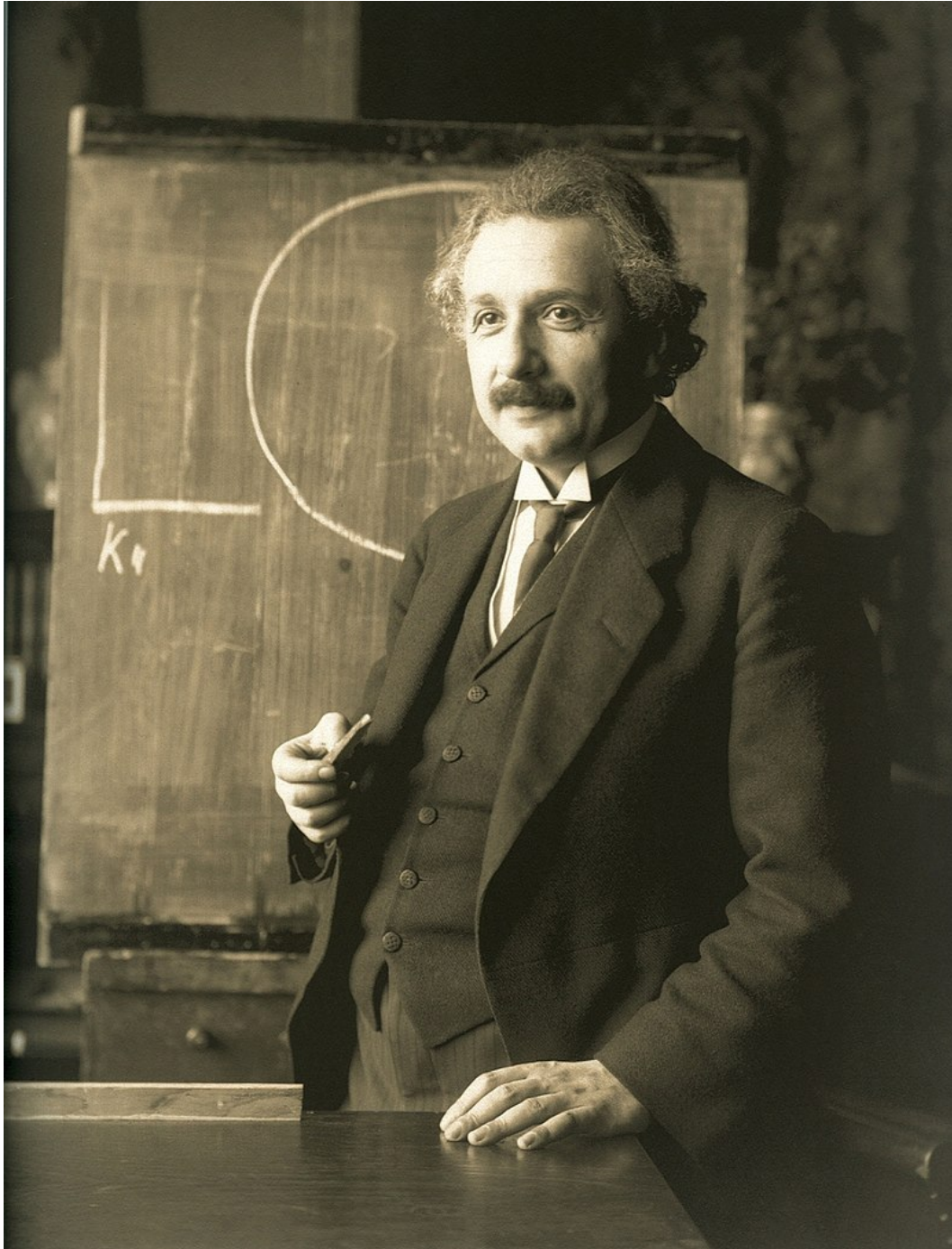

Figure 1.7: Albert Einstein (1879-1955) during a lecture in Vienna in 1921.

1.8 Edwin Hubble

Edwin Hubble's father wanted him to become a lawyer, and following his father's dying request, he studied law, first at the University of Chicago, and then at Oxford University. However, his true passion was astronomy. During his Oxford law studies, he managed to take a number of science courses. After the end of World War I, he became a student at Cambridge University, this time abandoning law and studying astronomy full-time.

In 1919, Hubble was offered a position at the Mount Wilson Observatory in Pasadena California, a position which he held until his death in 1953. Just as Hubble arrived, the Mount Wilson Observatory acquired the 100 inch Hooker telescope. At that time it was the world's largest, and it helped Hubble to make his important discoveries.

Hubble's special attention was drawn to the Cepheid variable stars, whose brightness varied with a characteristic period. A relationship between the period of Cepheid variable stars and their luminosity had been discovered in 1908 by Henrietta Swan Leavitt. Her discovery allowed astronomers to calculate the distance of a variable star by comparing its period with its apparent brightness. Using this relationship, Hubble was able to show that some of the variable stars which he could observe with the Hooker telescope were too far away to be part of our own galaxy. His studies of the Andromeda nebula, which had previously been thought to be a cloud of gas within our own galaxy, proved that it was in fact an entire galaxy very similar to our own Milky Way.

Edwin Hubble used the Doppler effect to make a second extremely important discovery. When a star is moving away from the earth, the light from the star is shifted to the red. In other words each colour of light has a longer wave length than it would have if the star were stationary or moving towards us. This is similar to the effect that we can notice when the sound of the whistle of an approaching railway train falls in pitch as the train passes us and moves away. Hubble discovered that the red shift due to the Doppler effect is greatest for the galaxies that are farthest from the earth. This discovery, which is known as Hubble's Law, is interpreted by most astronomers as indicating that our universe as a whole is expanding.

In 1924, Edwin Hubble, who was then 35 years old, announced his epoch-making discoveries in the New York Times. In January, 1925, he followed this announcement with a formal paper, presented to a meeting of the American Astronomical Society.

Hubble's name is perhaps best known to the public because of the space telescope named after him. Why put a telescope into space? The reason is that for telescopes on even the highest of mountains, fluctuations in the density of air above them limits the resolution that they can achieve. Since the Hubble space telescope is completely above the earth's atmosphere, it has been able to send us remarkable images of our universe.



Figure 1.8: **Edwin Hubble (1889-1953).**



Figure 1.9: **The Andromeda spiral nebula.**



Figure 1.10: The Hubble space telescope

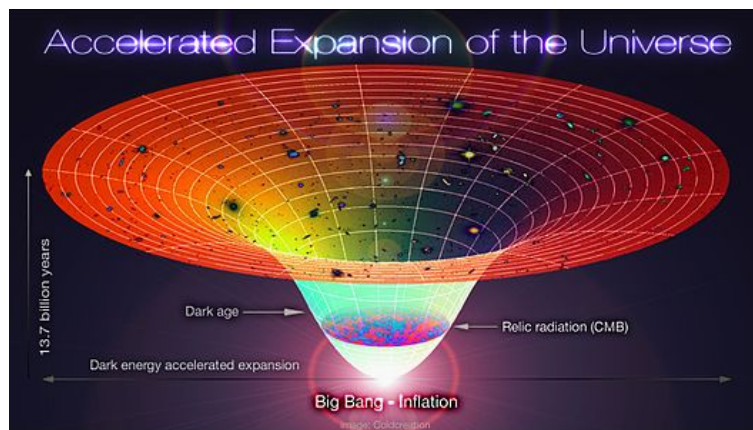

Figure 1.11: The standard model of our universe.



Figure 1.12: Arno Penzias and Robert Woodrow Wilson, discoverers of the echo of the Big Bang.

1.9 The Big Bang

If the Universe is expanding, as Hubble's Law suggests, then it is logical to extrapolate backward in time, and to suppose that the Universe expanded outward from one place. According to this model this model, which is called the *Standard Model* of cosmology, or *Big Bang Theory*, the Universe exploded outward from an extremely hot and dense initial state, gradually cooling as it expanded.¹

The Standard Model was first proposed 1927 by Georges Lemaitre and Alexander Friedmann on the basis of their solutions to Einstein's general relativistic equations. In 1929 the model was supported by Hubble's discoveries. Until the late 1950's, there were competing models, such as the Steady State Cosmology proposed by Fred Hoyle. However in more recent times, very strong evidence has accumulated to support the Standard Model. This evidence includes the large-scale structure of the Universe, the abundances of elements.

Crucial evidence supporting the Standard Model was discovered by accident in 1964. Working at the Bell Laboratories in New Jersey, Arno Penzias and Robert Woodrow Wilson were experimenting with a super-sensitive 6 meter microwave horn antenna designed to pick up the signals from radio waves bounced off Echo balloon satellites. They tried to remove all the interfering signals from radar and radio broadcasts by cooling their receiver with liquid helium. However, despite their efforts, they could not get rid of a mysterious microwave background radiation that seemed to be coming equally from all directions, both day and night. They had no idea of what was causing this mysterious background.

Meanwhile, at Princeton University, only sixty miles away, astrophysicists Robert H. Dicke, Jim Peebles and David Wilkinson, building on the earlier work of George Gamow, had

¹Today this initial state is believed to have been infinitely hot and infinitely dense, i.e. a *singularity*.

written a paper on the cosmic background radiation that they thought should be present on theoretical grounds. During the expansion and cooling of the Universe, a moment occurred when atoms formed, and the radiation characteristic of the temperature at that time was suddenly free to propagate outward. By now, the Princeton group calculated, this radiation should be red shifted so far that it would now lie in the microwave region.

As it happened, Bernard F. Burke of MIT knew of both the Bell Labs experiments and the Princeton group's theoretical work. He brought them all together, and a joint publication was arranged. In 1978, Penzias and Wilson were awarded a Nobel Prize on Physics for their experimental discovery of what might be called "the echo of the Big Bang". This was the crucial piece of evidence supporting the Standard Model.

Today, our Universe is believed to be 13.72 billion years old. When it cooled enough for atoms to form, only hydrogen and extremely small amounts of helium were present. The heavier elements are thought to have been synthesized through nuclear reactions in the interior of stars.

The Wikipedia article on stellar evolution states that *all stars are born from collapsing clouds of gas and dust... Over the course of millions of years, these protostars settle down into a state of equilibrium, becoming what is known as a main-sequence star.*

Nuclear fusion powers a star for most of its life. Initially the energy is generated by the fusion of hydrogen atoms at the core of the main-sequence star. Later, as the preponderance of atoms at the core becomes helium, stars like the Sun begin to fuse hydrogen along a spherical shell surrounding the core. This process causes the star to gradually grow in size, passing through the subgiant stage until it reaches the red giant phase. Stars with at least half the mass of the Sun can also begin to generate energy through the fusion of helium at their core, whereas more-massive stars can fuse heavier elements along a series of concentric shells. Once a star like the Sun has exhausted its nuclear fuel, its core collapses into a dense white dwarf and the outer layers are expelled as a planetary nebula. Stars with around ten or more times the mass of the Sun can explode in a supernova as their inert iron cores collapse into an extremely dense neutron star or black hole. Although the universe is not old enough for any of the smallest red dwarfs to have reached the end of their lives, stellar models suggest they will slowly become brighter and hotter before running out of hydrogen fuel and becoming low-mass white dwarfs.

Our local star, the sun, is middle-sized and middle-aged. It was formed an estimated 4.6 billion years ago, and will last another 5 billion years or so before expanding into a red giant. At the moment it lies on the main sequence in the temperature-luminosity diagram. Evidence from abundances of radioactive elements and their decay products indicates that our earth was formed soon after the sun, roughly 4.54 billion years ago.

Modern astronomy has shown the Universe to be almost unimaginably large. Wikipedia states that: "The size of the Universe is unknown; it may be infinite. The region visible from Earth (the observable universe) is a sphere with a radius of about 46 billion light years, based on where the expansion of space has taken the most distant objects observed. For comparison, the diameter of a typical galaxy is 30,000 light-years, and the typical distance between two neighboring galaxies is 3 million light-years. As an example, the Milky Way Galaxy is roughly 100,000 light years in diameter, and the nearest sister galaxy

to the Milky Way, the Andromeda Galaxy, is located roughly 2.5 million light years away. There are probably more than 100 billion (10^{11}) galaxies in the observable Universe. Typical galaxies range from dwarfs with as few as ten million (10^7) stars up to giants with one trillion (10^{12}) stars, all orbiting the galaxy's center of mass. A 2010 study by astronomers estimated that the observable Universe contains 300 sextillion (3×10^{23}) stars."

Among this incredibly vast number of stars it is believed that there are innumerable stars that have planets similar to the Earth and hence able to support life. We also now know that given conditions that are favorable to life, it will almost certainly develop and evolve. The Earth seems to be only of extremely minor importance on the scale of the Universe. Given these facts, and given that the fundamental laws of nature are mathematical, it is difficult to maintain that the entire Universe and the laws that govern it were arranged for the benefit of humans, especially since humans have only existed for a brief instant on the time-scale of the Universe. If asked where the Universe came from and why, the scientist must answer with honesty, "I don't know".

1.10 Timeline of epochs in cosmology

For readers with a taste for particle physics and/or astronomy, here is a cosmological timeline from a Wikipedia article entitled *Timeline of epochs in cosmology*. (Other readers can skip directly to the next chapter!)

Planck epoch

- **c. 0 seconds (13.799 ± 0.021 Gya): Planck Epoch begins: earliest meaningful time.** The Big Bang occurs in which ordinary space and time develop out of a primeval state (possibly a virtual particle or false vacuum) described by a quantum theory of gravity or "Theory of Everything". All matter and energy of the entire visible universe is contained in a hot, dense point (gravitational singularity), a billionth the size of a nuclear particle. This state has been described as a particle desert. Other than a few scant details, conjecture dominates discussion about the earliest moments of the universe's history since no effective means of testing this far back in space-time is presently available. WIMPS (weakly interacting massive particles) or dark matter and dark energy may have appeared and been the catalyst for the expansion of the singularity. The infant universe cools as it begins expanding outward. It is almost completely smooth, with quantum variations beginning to cause slight variations in density.

Grand unification epoch

- c. 10^{-43} seconds: Grand unification epoch begins: While still at an infinitesimal size, the universe cools down to 10^{32} kelvin. Gravity separates and begins operating on the universe - the remaining fundamental forces stabilize into the electronuclear force, also known as the Grand Unified Force or Grand Unified Theory (GUT), mediated by (the hypothetical) X and Y bosons which allow early matter at this stage to fluctuate between baryon and lepton states.

Electroweak epoch

- c. 10^{-36} seconds: Electroweak epoch begins: The Universe cools down to 1028 kelvin. As a result, the strong nuclear force becomes distinct from the electroweak force perhaps fuelling the inflation of the universe. A wide array of exotic elementary particles result from decay of X and Y bosons which include W and Z bosons and Higgs bosons.
- c. 10^{-33} seconds: Space is subjected to inflation, expanding by a factor of the order of 1026 over a time of the order of 10^{-33} to 10^{-32} seconds. The universe is supercooled from about 10^{27} down to 10^{22} kelvin.
- c. 10^{-32} seconds: Cosmic inflation ends. The familiar elementary particles now form as a soup of hot ionized gas called quark-gluon plasma; hypothetical components of cold dark matter (such as axions) would also have formed at this time.

Quark epoch

- c. 10^{-12} seconds: Electroweak phase transition: the four fundamental interactions familiar from the modern universe now operate as distinct forces. The weak nuclear force is now a short-range force as it separates from electromagnetic force, so matter particles can acquire mass and interact with the Higgs Field. The temperature is still too high for quarks to coalesce into hadrons, and the quark-gluon plasma persists (Quark epoch). The universe cools to 10^{15} kelvin.
- c. 10^{-11} seconds: Baryogenesis may have taken place with matter gaining the upper hand over anti-matter as baryon to antibaryon constituencies are established.

Hadron epoch

- c. 10^{-6} seconds: Hadron epoch begins: As the universe cools to about 10^{10} kelvin, a quark-hadron transition takes place in which quarks bind to form more complex particles - hadrons. This quark confinement includes

the formation of protons and neutrons (nucleons), the building blocks of atomic nuclei.

Lepton epoch

- c. 1 second: Lepton epoch begins: The universe cools to 10^9 kelvin. At this temperature, the hadrons and antihadrons annihilate each other, leaving behind leptons and antileptons - possible disappearance of antiquarks. Gravity governs the expansion of the universe: neutrinos decouple from matter creating a cosmic neutrino background.

Photon epoch

- c. 10 seconds: Photon epoch begins: Most of the leptons and antileptons annihilate each other. As electrons and positrons annihilate, a small number of unmatched electrons are left over - disappearance of the positrons.
- c. 10 seconds: Universe dominated by photons of radiation - ordinary matter particles are coupled to light and radiation while dark matter particles start building non-linear structures as dark matter halos. Because charged electrons and protons hinder the emission of light, the universe becomes a super-hot glowing fog.
- c. 3 minutes: Primordial nucleosynthesis: nuclear fusion begins as lithium and heavy hydrogen (deuterium) and helium nuclei form from protons and neutrons.
- c. 20 minutes: Nuclear fusion ceases: normal matter consists of 75% hydrogen nuclei and 25% helium nuclei - free electrons begin scattering light.

Matter era

Matter and radiation equivalence

- c. 47,000 years ($z=3600$): Matter and radiation equivalence: at the beginning of this era, the expansion of the universe was decelerating at a faster rate.
- c. 70,000 years: Matter domination in Universe: onset of gravitational collapse as the Jeans length at which the smallest structure can form begins to fall.

Cosmic Dark Age

- c. 370,000 years ($z=1,100$): The “Dark Ages” is the period between decoupling, when the universe first becomes transparent, until the formation

of the first stars. **Recombination:** electrons combine with nuclei to form atoms, mostly hydrogen and helium. Distributions of hydrogen and helium at this time remains constant as the electron-baryon plasma thins. The temperature falls to 3000 kelvin. Ordinary matter particles decouple from radiation. The photons present at the time of decoupling are the same photons that we see in the cosmic microwave background (CMB) radiation.

- c. 400,000 years: Density waves begin imprinting characteristic polarization (waves) signals.
- c. 10-17 million years: The “Dark Ages” span a period during which the temperature of cosmic background radiation cooled from some 4000 K down to about 60 K. The background temperature was between 373 K and 273 K, allowing the possibility of liquid water, during a period of about 7 million years, from about 10 to 17 million after the Big Bang (redshift 137-100). Loeb (2014) speculated that primitive life might in principle have appeared during this window, which he called “the Habitable Epoch of the Early Universe”
- c. 100 million years: Gravitational collapse: ordinary matter particles fall into the structures created by dark matter. Reionization begins: smaller (stars) and larger non-linear structures (quasars) begin to take shape - their ultraviolet light ionizes remaining neutral gas.
- 200-300 million years: First stars begin to shine: Because many are Population III stars (some Population II stars are accounted for at this time) they are much bigger and hotter and their life-cycle is fairly short. Unlike later generations of stars, these stars are metal free. As reionization intensifies, photons of light scatter off free protons and electrons - Universe becomes opaque again.
- 200 million years: HD 140283, the “Methuselah” Star, formed, the unconfirmed oldest star observed in the Universe. Because it is a Population II star, some suggestions have been raised that second generation star formation may have begun very early on. The oldest-known star (confirmed) - SMSS J031300.36-670839.3, forms.
- 300 million years: First large-scale astronomical objects, protogalaxies and quasars may have begun forming. As Population III stars continue to burn, stellar nucleosynthesis operates - stars burn mainly by fusing hydrogen to produce more helium in what is referred to as the main sequence. Over time these stars are forced to fuse helium to produce carbon, oxygen, silicon and other heavy elements up to iron on the periodic table. These elements, when seeded into neighbouring gas clouds by supernova, will lead to the formation of more Population II stars (metal poor) and gas giants.
- 380 million years: UDFj-39546284 forms, current record holder for unconfirmed oldest-known quasar.

- 400 million years ($z=11$): GN-z11, the oldest-known galaxy, forms.
- 420 million years: The quasar MACS0647-JD, the, or one of the, furthest known quasars, forms.
- 600 million years HE 1523-0901, the oldest star found producing neutron capture elements forms, marking a new point in ability to detect stars with a telescope.
- 630 million years ($z=8.2$): GRB 090423, the oldest gamma ray burst recorded suggests that supernovas may have happened very early on in the evolution of the Universe.
- 670 million years: EGS-zs8-1, the most distant starburst or Lyman-break galaxy observed, forms. This suggests that galaxy interaction is taking place very early on in the history of the Universe as starburst galaxies are often associated with collisions and galaxy mergers.
- 700 million years: Galaxies form. Smaller galaxies begin merging to form larger ones. Galaxy classes may have also begun forming at this time including Blazars, Seyfert galaxies, radio galaxies, and dwarf galaxies as well as regular types (elliptical, barred spiral, and spiral galaxies). UDFy-38135539, the first distant quasar to be observed from the reionization phase, forms. Dwarf galaxy $z8$ GND 5296 forms. Galaxy or possible proto-galaxy A1689-zD1 forms.
- 720 million years: Possible formation of globular clusters in Milky Way's Galactic halo. Formation of globular cluster, NGC 6723, in the Milky Way's galactic halo.
- 740 million years: 47 Tucanae, second-brightest globular cluster in the Milky Way, forms.
- 750 million years: Galaxy IOK-1 a Lyman alpha emitter galaxy, forms. GN-108036 forms - galaxy is 5 times larger and 100 times more massive than the present day Milky Way illustrating the size attained by some galaxies very early on.
- 770 million years: Quasar ULAS J1120+0641, one of the most distant, forms. One of the earliest galaxies to feature a supermassive black hole suggesting that such large objects existed quite soon after the Big Bang. The large fraction of neutral hydrogen in its spectrum suggests it may also have just formed or is in the process of star formation.
- 800 million years: Farthest extent of Hubble Ultra Deep Field. Formation of SDSS J102915+172927: unusual population II star that is extremely metal poor consisting of mainly hydrogen and helium. HE0107-5240, one of the oldest Population II stars, forms as part of a binary star system. LAE J095950.99+021219.1, one of the most remote Lyman alpha emitter galaxies, forms. Lyman alpha emitters are considered to be the progenitors of spiral galaxies like the Milky Way. Messier 2, globular cluster, forms.

- 870 million years: Messier 30 forms in the Milky Way. Having experienced a Core collapse (cluster), the cluster has one of the highest densities among globular clusters.
- 890 million years: Galaxy SXDF-NB1006-2 forms.
- 900 million years: Galaxy BDF-3299 forms
- 910 million years: Galaxy BDF-521 forms.

Galaxy epoch

- 1 billion years (12.8 Gya, $z=6.56$): Galaxy HCM-6A, the most distant normal galaxy observed, forms. Formation of hyper-luminous quasar SDSS J0100+2802, which harbors a black hole with mass of 12 billion solar masses, one of the most massive black holes discovered so early in the universe. HE1327-2326, a population II star, is speculated to have formed from remnants of earlier Population III stars. Visual limit of the Hubble Deep Field. Reionization complete - the Universe becomes transparent again. Galaxy evolution continues as more modern looking galaxies form and develop. Because the Universe is still small in size, galaxy interactions become common place with larger and larger galaxies forming out of the galaxy merger process. Galaxies may have begun clustering creating the largest structures in the Universe so far - the first galaxy clusters and galaxy superclusters appear.
- 1.1 billion years (12.7 Gya): Age of the quasar CFHQS 1641+3755. Messier 4 Globular Cluster, first to have its individual stars resolved, forms in the halo of the Milky Way Galaxy. Among the clusters many stars, PSR B1620-26 b, a gas giant known as the “Genesis Planet” or “Methusaleh”, orbiting a pulsar and a white dwarf, the oldest observed extrasolar planet in Universe, forms.
- 1.13 billion years (12.67 Gya): Messier 12, globular cluster, forms.
- 1.3 billion years (12.5 Gya): WISE J224607.57-052635.0, a luminous infrared galaxy, forms. PSR J1719-1438 b, known as the Diamond Planet, forms around a pulsar.
- 1.31 billion years (12.49 Gya): Globular Cluster Messier 53 forms 60,000 light-years from the galactic centre of the Milky Way.
- 1.39 billion years (12.41 Gya): S5 0014+81, a hyper-luminous quasar, forms.
- 1.4 billion years (12.4 Gya): Age of Cayrel’s Star, BPS C531082-0001, a neutron capture star, among the oldest Population II stars in Milky Way. Quasar RD1, first object observed to exceed redshift 5, forms.
- 1.44 billion years (12.36 Gya): Messier 80 globular cluster forms in Milky Way - known for large number of “blue stragglers”.
- 1.5 billion years (12.3 Gya): Messier 55, globular cluster, forms.

- 1.8 billion years (12 Gya): Most energetic gamma ray burst lasting 23 minutes, GRB 080916C, recorded. Baby Boom Galaxy forms. Terzan 5 forms as a small dwarf galaxy on collision course with the Milky Way. Dwarf galaxy carrying the Methusaleh Star consumed by Milky Way - oldest-known star in the Universe becomes one of many population II stars of the Milky Way.
- 2.0 billion years (11.8 Gya): SN 1000+0216, the oldest observed supernova occurs - possible pulsar formed. Globular Cluster Messier 15, known to have an intermediate black hole and the only globular cluster observed to include a planetary nebula, Pease 1, forms.
- 2.02 billion years (11.78 Gya): Messier 62 forms - contains high number of variable stars (89) many of which are RR Lyrae stars.
- 2.2 billion years (11.6 Gya): Globular Cluster NGC 6752, third-brightest, forms in Milky Way.
- 2.4 billion years (11.4 Gya): Quasar PKS 2000-330 forms.
- 2.41 billion years (11.39 Gya): Messier 10 globular cluster forms. Messier 3 forms: prototype for the Oosterhoff type I cluster, which is considered “metal-rich”. That is, for a globular cluster, Messier 3 has a relatively high abundance of heavier elements.
- 2.5 billion years (11.3 Gya): Omega Centauri, largest globular cluster in the Milky Way forms.
- 3.0 billion years (10.8 billion Gya): Formation of the Gliese 581 planetary system: Gliese 581c, the first observed ocean planet and Gliese 581d, a super-earth planet, possibly the first observed habitable planets, form. Gliese 581d has more potential for forming life since it is the first exoplanet of terrestrial mass proposed that orbits within the habitable zone of its parent star.
- 3.3 billion years (10.5 Gya): BX442, oldest grand design spiral galaxy observed, forms.
- 3.5 billion years (10.3 Gya): Supernova SN UDS10Wil recorded.
- 3.8 billion years (10 Gya): NGC 2808 globular cluster forms: 3 generations of stars form within the first 200 million years.
- 4.0 billion years (9.8 Gya): Quasar 3C 9 forms. The Andromeda Galaxy forms from a galactic merger - begins a collision course with the Milky Way. Barnard’s Star, red dwarf star, may have formed. Beethoven Burst GRB 991216 recorded. Gliese 677 Cc, a planet in the habitable zone of its parent star, Gliese 667, forms.
- 4.5 billion years (9.3 Gya): Fierce star formation in Andromeda making it into a luminous infra-red galaxy.
- 5.0 billion years (8.8 Gya): Earliest Population I, or Sunlike stars: with heavy element saturation so high, planetary nebula appear in which rocky substances are solidified - these nurseries lead to the formation of rocky terrestrial planets, moons, asteroids, and icy comets.

- 5.1 billion years (8.7 Gya): Galaxy collision: spiral arms of the Milky Way form leading to major period of star formation.
- 5.3 billion years (8.5 Gya): 55 Cancri B, a “hot Jupiter”, first planet to be observed orbiting as part of a star system, forms. Kepler 11 planetary system, the flattest and most compact system yet discovered, forms - Kepler 11 c considered to be a giant ocean planet with hydrogen-helium atmosphere.
- 5.8 billion years (8 Gya): 51 Pegasi b also known as Bellerophon, forms - first planet discovered orbiting a main sequence star.
- 5.9 billion years (7.9 Gya): HD 176051 planetary system, known as the first observed through astrometrics, forms.
- 6.0 billion years (7.8 Gya): Many galaxies like NGC 4565 become relatively stable - ellipticals result from collisions of spirals with some like IC 1101 being extremely massive.
- 6.0 billion years (7.8 Gya): The Universe continues to organize into larger wider structures. The great walls, sheets and filaments consisting of galaxy clusters and superclusters and voids crystallize. How this crystallization takes place is still conjecture. Certainly, it is possible the formation of super-structures like the Hercules-Corona Borealis Great Wall may have happened much earlier, perhaps around the same time galaxies first started appearing. Either way the observable universe becomes more modern looking.
- 6.2 billion years (7.7 Gya): 16 Cygni Bb, the first gas giant observed in a single star orbit in a trinary star system, forms - orbiting moons considered to have habitable properties or at the least capable of supporting water.
- 6.3 billion years (7.5 Gya, $z=0.94$): GRB 080319B, farthest gamma ray burst seen with the naked eye, recorded. Terzan 7, metal-rich globular cluster, forms in the Sagittarius Dwarf Elliptical Galaxy.
- 6.5 billion years (7.3 Gya): HD 10180 planetary system forms (larger than both 55 Cancri and Kepler 11 systems).
- 6.9 billion years (6.9 Gya): Orange Giant, Arcturus, forms.
- 7 billion years (6.8 Gya): North Star, Polaris, one of the significant navigable stars, forms.
- 7.64 billion years (6.16 Gya): Mu Arae planetary system forms: of four planets orbiting a yellow star, Mu Arae c is among the first terrestrial planets to be observed from Earth.
- 7.8 billion years (6.0 Gya): Formation of Earth’s near twin, Kepler 452b orbiting its parent star Kepler 452.
- 7.98 billion years (5.82 Gya): Formation of Mira or Omicron ceti, binary star system. Formation of Alpha Centauri Star System, closest star to the Sun - formation of Alpha Centauri Bb closest planet to the Sun. GJ 1214 b, or Gliese 1214 b, potential earth-like planet, forms.
- 8.08-8.58 billion years (5.718-5.218 Gya): Capella star system forms.

- 8.2 billion years (5.6 Gya): Tau Ceti, nearby yellow star forms: five planets eventually evolve from its planetary nebula, orbiting the star - Tau Ceti e considered planet to have potential life since it orbits the hot inner edge of the star's habitable zone.
- 8.5 billion years (5.3 Gya): GRB 101225A, the "Christmas Burst", considered the longest at 28 minutes, recorded.

Acceleration

- 8.8 billion years (5 Gya, $z=0.5$): Acceleration: dark-energy dominated era begins, following the matter-dominated era during which cosmic expansion was slowing down.
- 8.8 billion years (5 Gya): Messier 67 open star cluster forms: Three exoplanets confirmed orbiting stars in the cluster including a twin of our Sun.
- 9.0 billion years (4.8 Gya): Lalande 21185, red dwarf in Ursa Major, forms.
- 9.13 billion years (4.67 Gya): Proxima Centauri forms completing the Alpha Centauri trinary system,

Epochs of the formation of the solar system

- 9.2 billion years (4.6-4.57 Gya): Primal supernova, possibly triggers the formation of the Solar System.
- 9.2318 billion years (4.5682 Gya): Sun forms - Planetary nebula begins accretion of planets.
- 9.23283 billion years (4.56717-4.55717 Gya): Four Jovian planets (Jupiter, Saturn, Uranus, Neptune) evolve around the sun.
- 9.257 billion years (4.543-4.5 Gya): Solar System of Eight planets, four terrestrial (Mercury (planet), Venus, Earth, Mars) evolve around the sun. Because of accretion many smaller planets form orbits around the proto-Sun some with conflicting orbits - Early Bombardment Phase begins. Pre-cambrian Supereon and Hadean eon begin on the Earth. Pre-Noachian Era begins on Mars. Pre-Tolstojan Period begins on Mercury - a large planetoid strikes Mercury stripping it of outer envelope of original crust and mantle, leaving the planet's core exposed - Mercury's iron content is notably high. Vega, fifth-brightest star in our galactic neighbourhood, forms. Many of the Galilean moons may have formed at this time including Europa and Titan which may presently be hospitable to some form of living organism.
- 9.266 billion years (4.533 Gya): Formation of Earth-Moon system following giant impact by hypothetical planetoid Theia (planet). Moon's

gravitational pull helps stabilize Earth's fluctuating axis of rotation. Pre-Nectarian Period begins on Moon.

- 9.271 billion years (4.529 Gya): Major collision with a pluto-sized planetoid establishes the Martian dichotomy on Mars - formation of North Polar Basin of Mars.
- 9.3 billion years (4.5 Gya): Sun becomes a main sequence yellow star: formation of the Oort Cloud and Kuiper Belt from which a stream of comets like Halley's Comet and Hale-Bopp begins passing through the Solar System, sometimes colliding with planets and the Sun.
- 9.396 billion years (4.404 Gya): Liquid water may have existed on the surface of the Earth, probably due to the greenhouse warming of high levels of methane and carbon dioxide present in the atmosphere.
- 9.4 billion years (4.4 Gya): Formation of Kepler 438 b, one of the most Earth-like planets, from a protoplanetary nebula surrounding its parent star.
- 9.5 billion years (4.3 Gya): Massive meteorite impact creates South Pole Aitken Basin on the Moon - a huge chain of mountains located on the lunar southern limb, sometimes called "Leibnitz mountains", form.
- 9.6 billion years (4.2 Gya): Tharsis Bulge widespread area of vulcanism, becomes active on Mars - based on the intensity of volcanic activity on Earth, Tharsis magmas may have produced a 1.5-bar CO₂ atmosphere and a global layer of water 120 m deep increasing greenhouse gas effect in climate and adding to Martian water table. Age of the oldest samples from the Lunar Maria.
- 9.7 billion years (4.1 Gya): Resonance in Jupiter and Saturn's orbits moves Neptune out into the Kuiper belt causing a disruption among asteroids and comets there. As a result, Late Heavy Bombardment batters the inner Solar System. Herschel Crater formed on Mimas (moon), a moon of Saturn. Meteorite impact creates the Hellas Planitia on Mars, the largest unambiguous structure on the planet. Anseris Mons an isolated massif (mountain) in the southern highlands of Mars, located at the northeastern edge of Hellas Planitia is uplifted in the wake of the meteorite impact.
- 9.8 billion years (4 Gya): HD 209458 b, first planet detected through its transit, forms. Messier 85, lenticular galaxy, disrupted by galaxy interaction: complex outer structure of shells and ripples results. Andromeda and Triangulum galaxies experience close encounter - high levels of star formation in Andromeda while Triangulum's outer disc is distorted.
- 9.861 billion years (3.938 Gya): Major period of impacts on the Moon: Mare Imbrium forms.
- 9.88 billion years (3.92 Gya): Nectaris Basin forms from large impact event: ejecta from Nectaris forms upper part of densely cratered Lunar Highlands - Nectarian Era begins on the Moon.

- 9.9 billion years (3.9 Gya): Tolstoj (crater) forms on Mercury. Caloris Basin forms on Mercury leading to creation of “Weird Terrain” - seismic activity triggers volcanic activity globally on Mercury. Rembrandt (crater) formed on Mercury. Caloris Period begins on Mercury. Argyre Planitia forms from asteroid impact on Mars: surrounded by rugged massifs which form concentric and radial patterns around basin - several mountain ranges including Charitum and Nereidum Montes are uplifted in its wake.
- 9.95 billion years (3.85 Gya): Beginning of Late Imbrium Period on Moon. Earliest appearance of Procellarum KREEP Mg suite materials.
- 9.96 billion years (3.84 Gya): Formation of Orientale Basin from asteroid impact on Lunar surface - collision causes ripples in crust, resulting in three concentric circular features known as Montes Rook and Montes Cordillera.
- 10 billion years (3.8 Gya): In the wake of Late Heavy Bombardment impacts on the Moon, large molten mare depressions dominate lunar surface - major period of Lunar vulcanism begins (to 3 Gyr). Archean eon begins on the Earth.
- 10.2 billion years (3.6 Gya): Alba Mons forms on Mars, largest volcano in terms of area.
- 10.4 billion years (3.5 Gya): Earliest fossil traces of life on Earth (stromatolites).
- 10.6 billion years (3.2 Gya): Amazonian Period begins on Mars: Martian climate thins to its present density: groundwater stored in upper crust (megaregolith) begins to freeze, forming thick cryosphere overlying deeper zone of liquid water - dry ices composed of frozen carbon dioxide form Eratosthenian period begins on the Moon: main geologic force on the Moon becomes impact cratering.
- 10.8 billion years (3 Gya): Beethoven Basin forms on Mercury - unlike many basins of similar size on the Moon, Beethoven is not multi ringed and ejecta buries crater rim and is barely visible.
- 11.2 billion years (2.5 Gya): Proterozoic begins.
- 11.6 billion years (2.2 Gya): Last great tectonic period in Martian geologic history: Valles Marineris, largest canyon complex in the Solar System, forms - although some suggestions of thermokarst activity or even water erosion, it is suggested Valles Marineris is rift fault.

Suggestions for further reading

1. Jaquetta Hawkes and Sir Leonard Wooley, *Prehistory and the Beginnings of Civilization*, George Allen and Unwin (1966).

2. Luigi Pareti, Paolo Brezzi and Luciano Petech, *The Ancient World*, George Allen and Unwin Ltd., London (1996).
3. James and Janet MacLean Todd, *Peoples of the Past*, Arrow Books Ltd., London (1963).
4. Georges Roux, *Ancient Iraq*, Penguin Books Ltd. (1966).
5. R. Ghirshman, *Iran*, Penguin Books Ltd. (1954).
6. Francesco Abbate, *Egyptian Art*, Octopus Books, London (1972).
7. Roger Ling, *The Greek World*, Elsevier-Phaidon, Oxford (1976).
8. Bertrand Russell, *History of Western Philosophy*, George Allen and Unwin Ltd., London (1946).
9. Michael Grant (editor), *Greek Literature*, Penguin Books Ltd. (1976).
10. George Sarton, *History of Science*, Oxford University Press (1959).
11. Morris Kline, *Mathematics in Western Culture*, Penguin Books Ltd. (1977).
12. E.T. Bell, *Men of Mathematics*, Simon and Schuster, New York (1937).
13. Isaac Asimov, *Asimov's Biographical Encyclopedia of Science and Technology*, Pan Books Ltd., London (1975).
14. O. Neugebauer, *The Exact Sciences in Antiquity*, Harper and Brothers (1962).
15. Joseph Needham, *Science and Civilization in China*, (4 volumes), Cambridge University Press (1954-1971).
16. Charles Singer, *A Short History of Scientific Ideas to 1900*, Oxford University Press (1959).
17. Ernst J. Grube, *The World of Islam*, Paul Hamlyn Ltd., London (1966).
18. Carl Brockelmann, *History of the Islamic Peoples*, Routledge and Kegan Paul (1949).
19. Marshall Clagett, *The Science of Mechanics in the Middle Ages*, The University of Wisconsin Press, Madison (1959).
20. Irma A. Richter (editor), *Selections from the Notebooks of Leonardo da Vinci*, Oxford University Press (1977).
21. Lorna Lewis, *Leonardo the Inventor*, Heinemann Educational Books, London (1974).
22. Iris Noble, *Leonardo da Vinci*, Blackie, London (1968).
23. C.H. Monk, *Leonardo da Vinci*, Hamlyn, London (1975).
24. Thomas S. Kuhn, *The Copernican Revolution*, Harvard University Press (1957).
25. Angus Armitage, *The World of Copernicus*, The New American Library, New York (1951).
26. Arthur Koestler, *The Watershed*, Heinemann, London (1961).
27. D.W. Singer, *Gordiano Bruno: His Life and Thought*, Greenwood Press, New York (1968).
28. Martin Olsson, *Uranienborg och Stjärneborg*, Almquist and Wiksell, Stockholm (1968).
29. Edward A. Gosselin and Lawrence S. Lerner, *Galileo and the Long Shadow of Bruno*, Archives Internationales d'Histoire des Sciences, **25**, 223 (1975).
30. Joseph C. Pitt, *Galileo, Human Knowledge and the Book of Nature; Method Replaces Metaphysics*, Kluwer, Dordrecht, (1992).
31. Michael Segre, *In the Wake of Galileo*, Rutgers University Press, New Brunswick, N.J., (1991).

32. Galileo Galilei, *Dialogues Concerning Two New Sciences*, Dover, New York (1954).
33. Michael Segre, *In the Wake of Galileo*, Rutgers University Press, New Brunswick, N.J., (1991).
34. Silvio A. Bedini, *The Pulse of Time; Galileo Galilei, the Determination of Longitude and the Pendulum Clock*, Olschki, Firenze, (1991).
35. Stillman Drake et al., *Nature, Experiment and the Sciences; Essays on Galileo and the History of Science*, Kluwer, Dordrecht, (1990).
36. Stillman Drake, *Galileo, Pioneer Scientist*, Toronto University Press, (1990).
37. Pietro Redondi, *Galileo Heretic*, Princeton University Press, (1987).
38. I. Bernard Cohen, *The Birth of a New Physics*, Heinemann, London (1960).
39. Stillman Drake, *Telescopes, Tides and Tactics; a Galilean Dialogue about the Starry Messenger and Systems of the World*, University of Chicago Press, (1980).
40. D.L. Hurd and J.J. Kipling (editors), *The Origins and Growth of Physical Science*, Penguin Books Ltd. (1964).
41. William A. Wallace, *Prelude to Galileo*, Reidel, Dordrecht, (1981).
42. Stillman Drake, *Telescopes, Tides and Tactics; a Galilean Dialogue about the Starry Messenger and Systems of the World*, University of Chicago Press, (1980).
43. K.J.J. Hintikka et al. editors, *Conference on the History and Philosophy of Science*, Reidel, Dordrecht, (1981).
44. Phillip Bricker and R.I.G. Hughs, *Philosophical Perspectives on Newtonian Science*, M.I.T. Press, Cambridge, Mass., (1990).
45. Zev Bechler, *Newton's Physics and the Conceptual Structure of the Scientific Revolution*, Kluwer, Dordrecht, (1991).
46. Zev Bechler, *Contemporary Newtonian Research*, Reidel, Dordrecht, (1982).
47. I. Bernard Cohen, *The Newtonian Revolution*, Cambridge University Press, (1980).
48. B.J.T. Dobbs, *The Janus Face of Genius; The Role of Alchemy in Newton's Thought*, Cambridge University Press, (1991).
49. Paul B. Scheurer and G. Debrock, *Newton's Scientific and Philosophical Legacy*, Kluwer, Dordrecht, (1988).
50. A. Rupert Hall, *Isaac Newton, Adventurer in Thought*, Blackwell, Oxford, (1992).
51. Frank Durham and Robert D. Purrington, *Some Truer Method; Reflections on the Heritage of Newton*, Columbia University Press, New York, (1990).
52. John Fauvel, *Let Newton Be*, Oxford University Press, (1989).
53. Brian Vickers, *English Science, Bacon to Newton*, Cambridge University Press, (1989).
54. John G. Burke, *The Uses of Science in the Age of Newton*, University of California Press, (1983).
55. A.I. Sabra, *Theories of Light from Descartes to Newton*, Cambridge University Press, (1991).
56. E.N. da Costa Andrade, *Isaac Newton*, Folcroft Library Editions, (1979).
57. Gideon Freudenthal, *Atom and Individual in the Age of Newton*, Reidel, Dordrecht, (1986).
58. Henry Guerlac, *Newton on the Continent*, Cornell University Press, (1981).

59. A.R. Hall, *Philosophers at War; the Quarrel Between Newton and Leibnitz*, Cambridge University Press, (1980).
60. Gale E. Christianson, *In the Presence of the Creator; Isaac Newton and his Times*, Free Press, New York, (1984).
61. Lesley Murdin, *Under Newton's Shadow; Astronomical Practices in the Seventeenth Century*, Hilger, Bristol, (1985).
62. H.D. Anthony, *Sir Isaac Newton*, Collier, New York (1961).
63. René Taton and Curtis Wilson, *Planetary Astronomy from the Renaissance to the Rise of Astrophysics*, Cambridge University Press, (1989).
64. Sir Oliver Lodge, *Pioneers of Science*, Dover, New York (1960).
65. Marie Boaz, *Robert Boyle and Seventeenth Century Chemistry*, Cambridge University Press (1958).
66. J.G. Crowther, *Scientists of the Industrial Revolution*, The Cresset Press, London (1962).
67. R.E. Schofield, *The Lunar Society of Birmingham*, Oxford University Press (1963).
68. L.T.C. Rolt, *Isambard Kingdom Brunel*, Arrow Books, London (1961).
69. J.D. Bernal, *Science in History*, Penguin Books Ltd. (1969).
70. Bertrand Russell, *The Impact of Science on Society*, Unwin Books, London (1952).
71. Wilbert E. Moore, *The Impact of Industry*, Prentice Hall (1965).
72. Charles Morazé, *The Nineteenth Century*, George Allen and Unwin Ltd., London (1976).
73. Carlo M. Cipolla (editor), *The Fontana Economic History of Europe*, Fontana/Collins, Glasgow (1977).
74. Richard Storry, *A History of Modern Japan*, Penguin Books Ltd. (1960).
75. Martin Gerhard Geisbrecht, *The Evolution of Economic Society*, W.H. Freeman and Co. (1972).
76. Roger Ling, *The Greek World*, Elsevier-Phaidon, Oxford (1976).
77. Bertrand Russell, *History of Western Philosophy*, George Allen and Unwin Ltd., London (1946).
78. Michael Grant (editor), *Greek Literature*, Penguin Books Ltd. (1976).
79. George Sarton, *History of Science*, Oxford University Press (1959).
80. Morris Kline, *Mathematics in Western Culture*, Penguin Books Ltd. (1977).
81. E.T. Bell, *Men of Mathematics*, Simon and Schuster, New York (1937).
82. Isaac Asimov, *Asimov's Biographical Encyclopedia of Science and Technology*, Pan Books Ltd., London (1975).
83. O. Neugebauer, *The Exact Sciences in Antiquity*, Harper and Brothers (1962).
84. Joseph Needham, *Science and Civilization in China*, (4 volumes), Cambridge University Press (1954-1971).
85. Charles Singer, *A Short History of Scientific Ideas to 1900*, Oxford University Press (1959).
86. Ernst J. Grube, *The World of Islam*, Paul Hamlyn Ltd., London (1966).
87. Carl Brockelmann, *History of the Islamic Peoples*, Routledge and Kegan Paul (1949).

88. Marshall Clagett, *The Science of Mechanics in the Middle Ages*, The University of Wisconsin Press, Madison (1959).
89. K.J.J. Hintikka et al. editors, *Conference on the History and Philosophy of Science*, Reidel, Dordrecht, (1981).

Chapter 2

EARLY HISTORY OF THE EARTH

2.1 Formation of the Sun and the Earth

Our local star, the Sun, was formed from molecular clouds in interstellar space, which had been produced by the explosion of earlier stars. Our Sun contains mainly hydrogen and a little helium, with very small amounts of heavier elements. The vast amounts of energy produced by the sun come mainly from a nuclear reaction in which hydrogen is converted into helium.

There were clouds of containing not only hydrogen and helium, but also heavier elements left swirling around the infant Sun. Gradually, over many millions of years, these condensed through a process of collision and accretion, to form the planets. In the four relatively small inner planets, Mercury, Venus, Earth and Mars, heavy elements predominate, while in the giants, Jupiter, Saturn, Uranus and Neptune, we find lighter elements.

The Sun accounts for 99.86% of the solar system's mass, while the four giant planets contain 99% of the remaining mass.

One *astronomical unit* (1 AU) is, by definition, the average distance of the earth from the sun, i.e. approximately 93 million miles or 150 million kilometers. In terms of this unit, the average distances of the planets from the sun are as follows: Mercury, 0.387 AU; Venus, 0.722 AU; Earth, 1.000 AU; Mars, 1.52 AU; Jupiter, 5.20 AU; Saturn, 9.58 AU; Uranus, 19.2 AU; Neptune, 30.1 AU.

The Solar System also includes the asteroid belt, which lies between the orbits of Mars and Jupiter; the Kuiper belt and scattered disc, which are populations of trans-Neptunian objects; the dwarf planets, Ceres, Pluto and Eris; and the comets. Many of the bodies in the solar system, including six of the planets, have natural satellites or moons. The Earth's moon was produced by collision with a Mars-sized body, soon after the formation of the Earth.

Of the four inner planets, the Earth is the only one that has large amounts of liquid water on its surface. When the Earth cooled sufficiently after the violent collision that gave us our Moon, oceans began to form, and life is believed to have originated in the oceans, approximately 3.8 billion years before the present.



Figure 2.1: Much experimental evidence supports the Standard Model of cosmology, according to which our Universe began in an enormously hot and dense state 15.8 billion years ago, from which it is exploding outward. By 10 billion years before the present it had cooled enough for the first stars to form. Our own local star, the Sun, was formed 4.54 billion years ago from dust clouds left when earlier stars exploded. These dust clouds contained not only large amounts of hydrogen and a little helium, but also small amounts of the heavy elements that are needed for life. These heavy elements had been produced by nuclear reactions in the core regions of earlier stars.

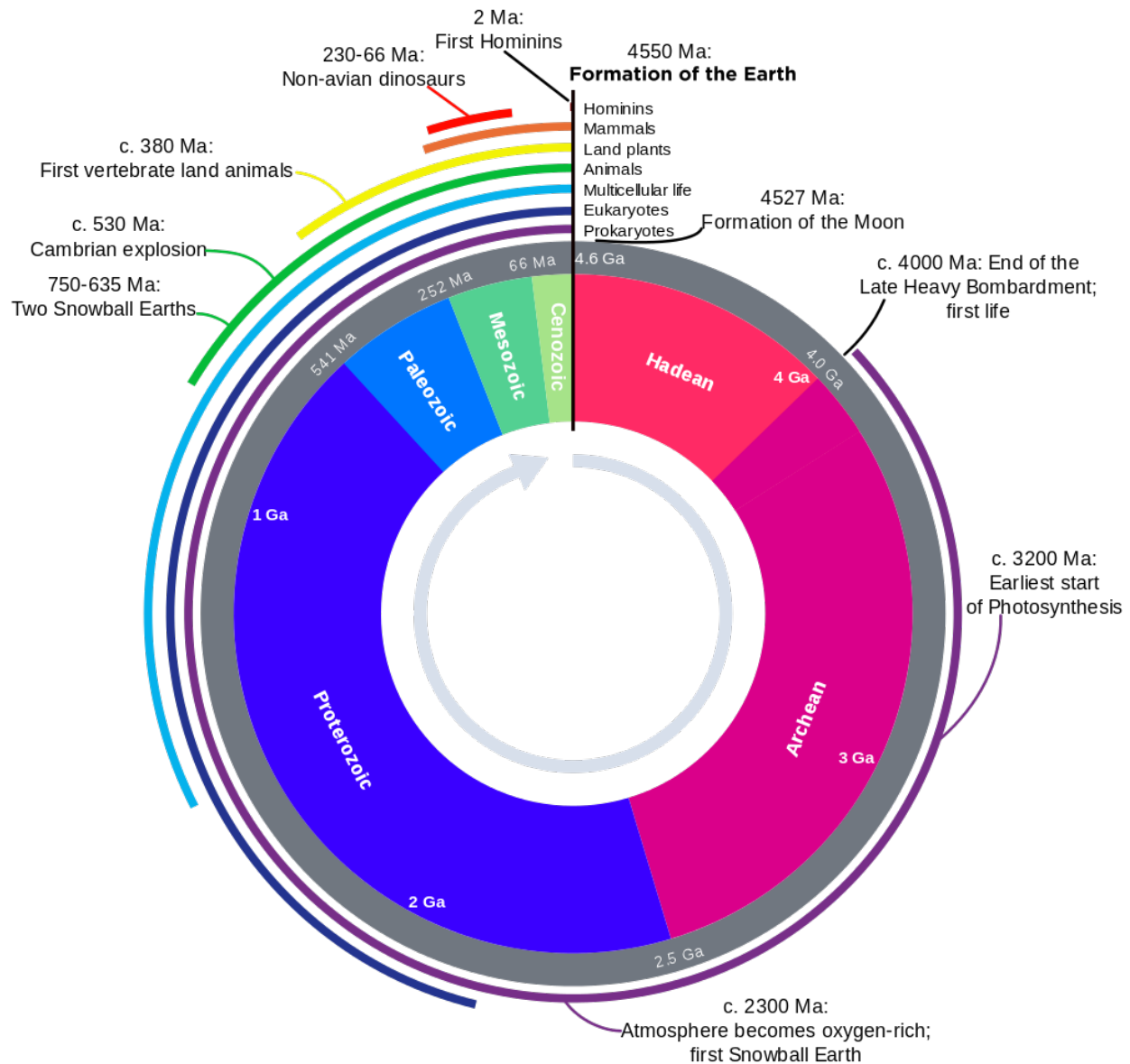

Figure 2.2: Geologic time represented in a diagram called a geological clock, showing the relative lengths of the eons of Earth's history and noting major events. During the Hadean eon, the earth was extremely hot, because of its recent accretion, the abundance of short-lived radioactive elements, and frequent collisions with other Solar System bodies. The word Hadean is derived from the name of the Greek god of the underworld, and it is used to describe the hellish conditions on the early earth. On the time-scale of this geological clock, humans appeared at the very last moment.

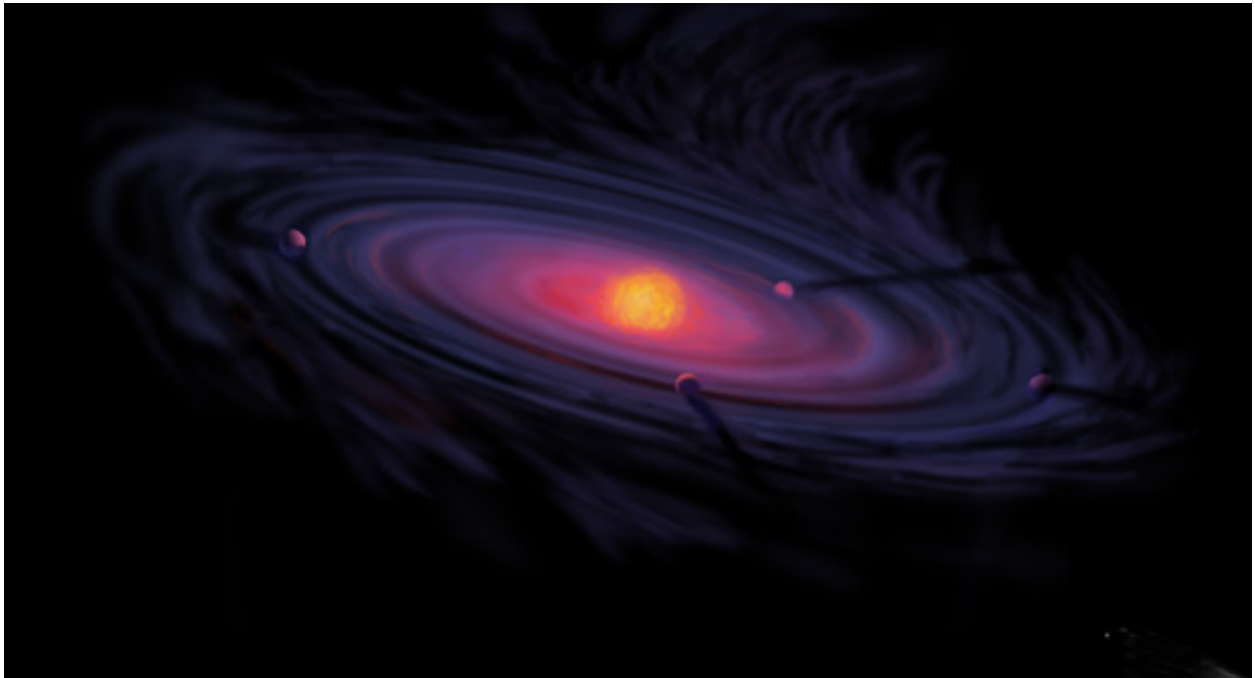

Figure 2.3: Artist's conception of a protoplanetary disc.

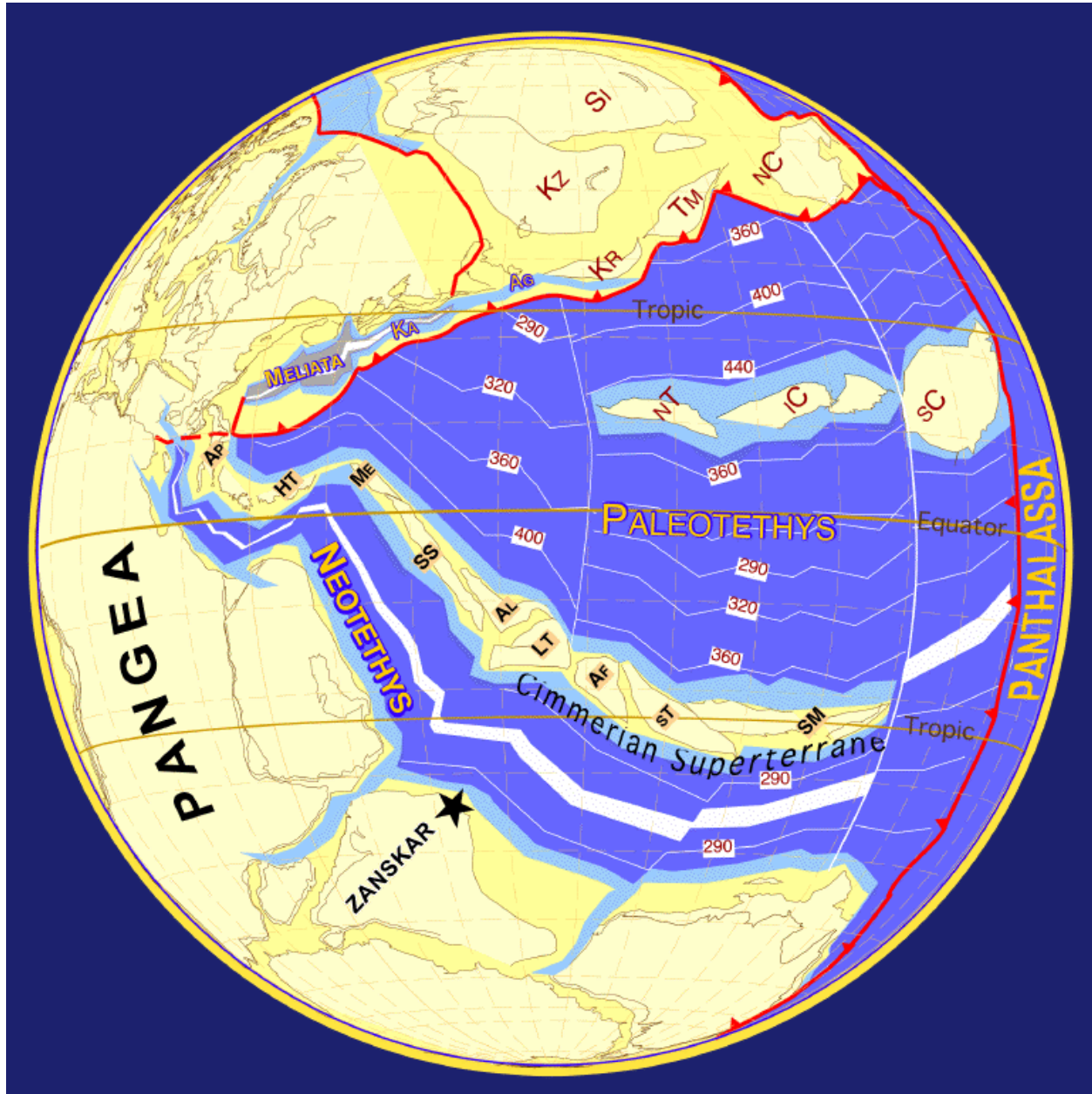

Figure 2.4: Plate tectonics - 249 million years ago. By that time, the earth had cooled sufficiently for a solid crust to form, but this crust was divided into fragments called “tectonic plates”. Currents in the molten rock beneath the plates dragged them into collision with each other, causing volcanism, and raising mountain ranges from former sea beds.



Figure 2.5: Plate tectonics- 290 million years ago.



Figure 2.6: Plate tectonics- 100 Ma, Cretaceous period.

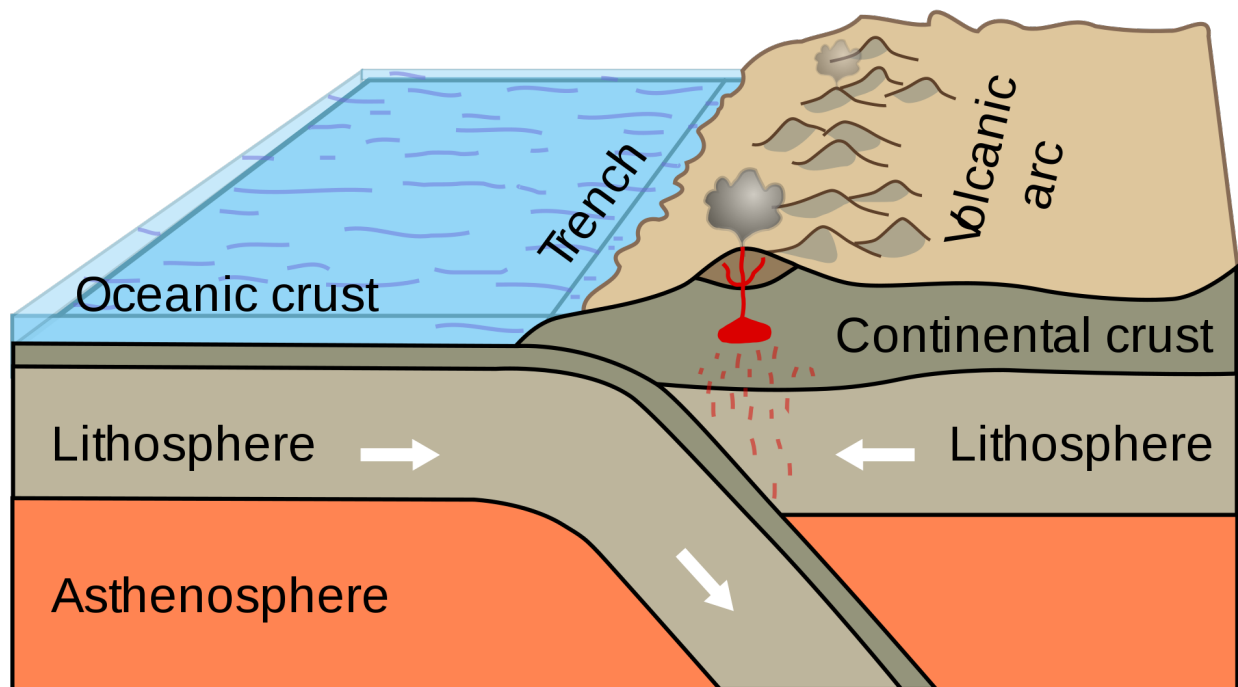

Figure 2.7: Oceanic-continental convergence resulting in subduction and volcanic arcs illustrates one effect of plate tectonics.

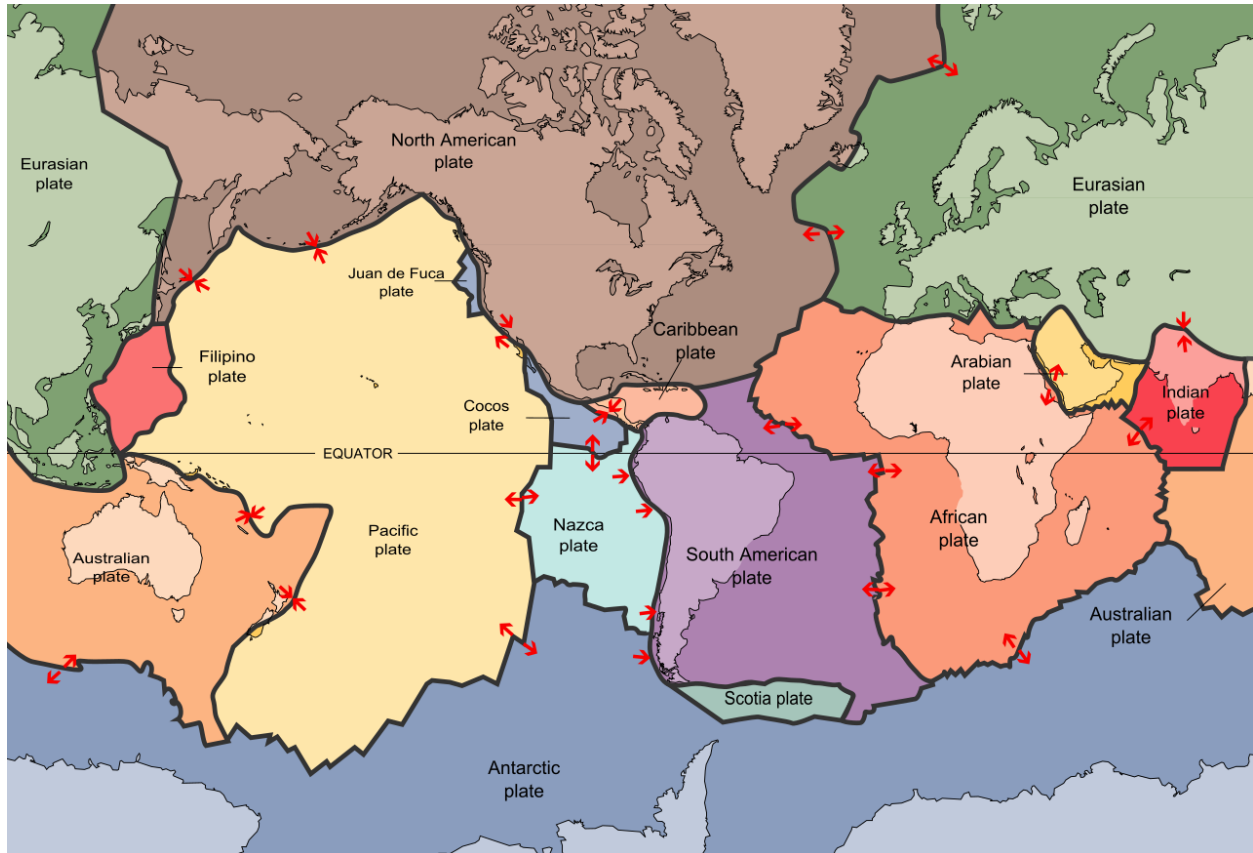

Figure 2.8: The major tectonic plates of the Earth. The key principle of plate tectonics is that the lithosphere exists as separate and distinct tectonic plates, which float on the fluid-like (visco-elastic solid) asthenosphere. The relative fluidity of the asthenosphere allows the tectonic plates to undergo motion in different directions.

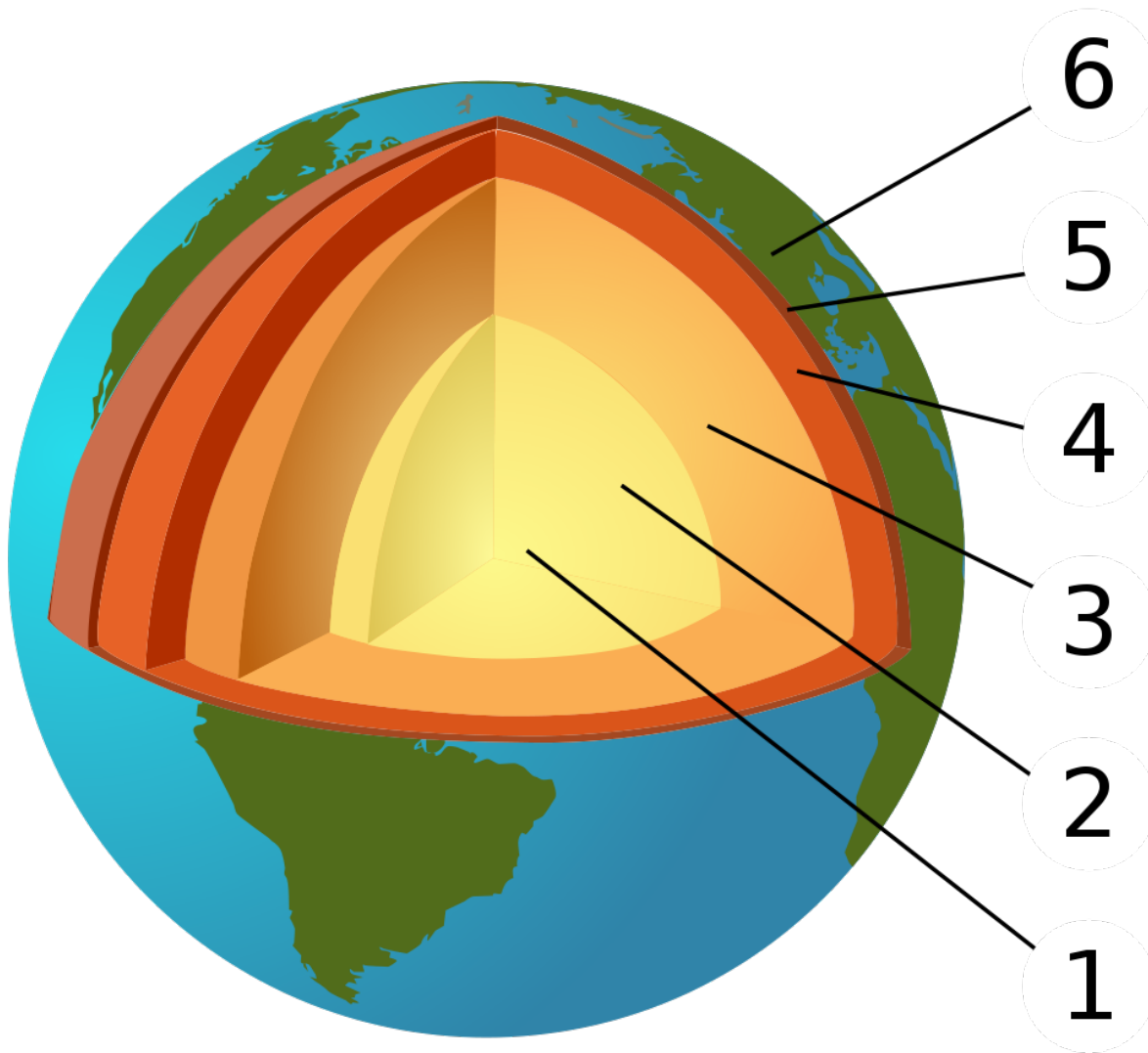

Figure 2.9: The Earth's layered structure. (1) inner core; (2) outer core; (3) lower mantle; (4) upper mantle; (5) lithosphere; (6) crust (part of the lithosphere). The extreme heat in the core of the earth is caused by the decay of radioactive elements. As the heat is conducted outward by convection currents, the currents are acted on by a combination of forces due to the earth's rotation, and forces from the magnetic fields produced by the currents themselves. The resulting magnetic field of the earth as a function of geological time can be calculated, but it is a complex problem in magneto-hydrodynamics. Similar considerations hold for the sun's magnetic field and the sunspot cycle.

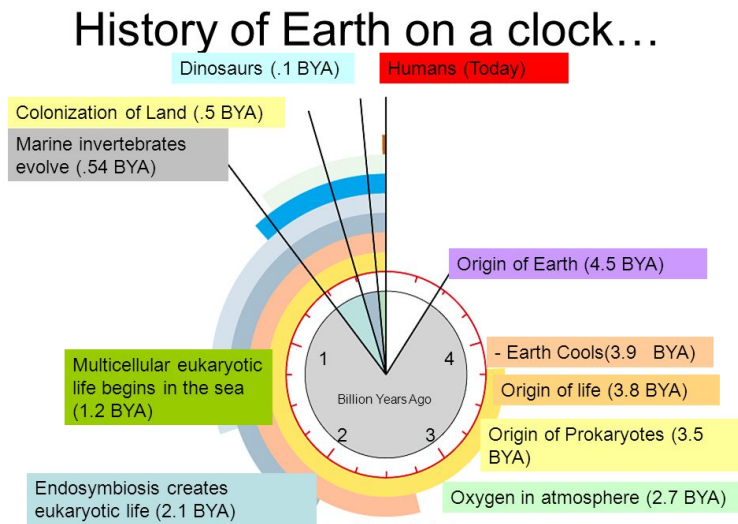

Figure 2.10: **The Earth was formed 4.54 billion years ago. Life on earth originated approximately 3.8 billion years ago (3.8 BYA).**

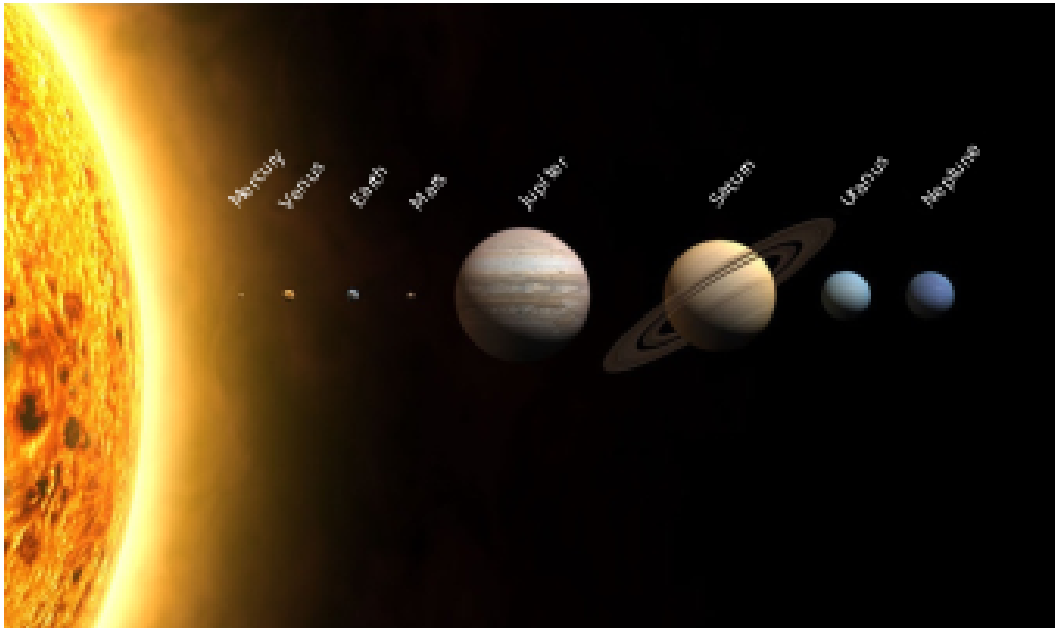

Figure 2.11: This figure shows the relative sizes of the planets. Closest to the Sun are the relatively small terrestrial planets, Mercury, Venus, Earth and Mars, composed of metals and rock. Farther out are two gas giants, Jupiter and Saturn, which are composed mainly of hydrogen and helium. Still farther out are two ice giants, Uranus and Neptune, which are composed mainly of frozen water, frozen ammonia and frozen methane. The distances of the planets from the Sun shown in this figure are not realistic. The planetary orbits lie in roughly in the same plane, which is called the ecliptic, and all the planets circle the Sun in the same direction.

2.2 The history of evolutionary theories

Before discussing modern theories of the origin and evolution of life on Earth, we will the ideas of some early pioneers of this field.

Aristotle, (384 BC - 322 BC)

Aristotle was a very great organizer of knowledge, and his writings almost form a one-man encyclopedia. His best work was in biology, where he studied and classified more than five hundred animal species, many of which he also dissected. In Aristotle's classification of living things, he shows an awareness of the interrelatedness of species. This interrelatedness was much later used by Darwin as evidence for the theory of evolution. One cannot really say that Aristotle developed a theory of evolution, but he was groping towards the idea. In his history of animals, he writes:

“Nature proceeds little by little from lifeless things to animal life, so that it is impossible to determine either the exact line of demarcation, or on which side of the line an intermediate form should lie. Thus, next after lifeless things in the upward scale comes the plant. Of plants, one will differ from another as to its apparent amount of vitality. In a word, the whole plant kingdom, whilst devoid of life as compared with the animal, is yet endowed with life as compared with other corporeal entities. Indeed, there is observed in plants a continuous scale of ascent towards the animal.”

Aristotle's classification of living things, starting at the bottom of the scale and going upward, is as follows: Inanimate matter, lower plants and sponges, higher plants, jellyfish, zoophytes and ascidians, molluscs, insects, jointed shellfish, octopuses and squids, fish and reptiles, whales, land mammals and man. The acuteness of Aristotle's observation and analysis can be seen from the fact that he classified whales and dolphins as mammals (where they belong) rather than as fish (where they superficially seem to belong, and where many ancient writers placed them).

Among Aristotle's biological writings, there appears a statement that clearly foreshadows the principle of natural selection, later independently discovered by Darwin and Wallace and fully developed by Darwin. Aristotle wrote: “Wheresoever, therefore... all parts of one whole happened like as if they were made for something, these were preserved, having been appropriately constituted by an internal spontaneity; and wheresoever things were not thus constituted, they perished, and still perish”.

Averröes

During the Middle Ages, Aristotle's evolutionary ideas were revived and extended in the writings of the Islamic philosopher Averröes¹, who lived in Spain from 1126 to 1198. His writings had a great influence on western thought. Averroes shocked both his Moslem and his Christian readers by his thoughtful commentaries on the works of Aristotle, in which

¹ Abul Walid Mahommed Ibn Achmed, Ibn Mahommed Ibn Rosched

he maintained that the world was not created at a definite instant, but that it instead evolved over a long period of time, and is still evolving.

Like Aristotle, Averröes seems to have been groping towards the ideas of evolution which were later developed in geology by Lyell and in biology by Darwin and Wallace. Much of the scholastic philosophy written at the University of Paris during the 13th century was aimed at refuting the doctrines of Averroes; but nevertheless, his ideas survived and helped to shape the modern picture of the world.

The mystery of fossils

During the lifetime of Leonardo da Vinci (1452-1519) the existence of fossil shells in the rocks of high mountain ranges was recognized and discussed. "...the shells in Lombardy are at four levels", Leonardo wrote, "and thus it is everywhere, having been made at various times...The stratified stones of the mountains are all layers of clay, deposited one above the other by the various floods of the rivers." Leonardo had no patience with the explanation given by some of his contemporaries, that the shells had been carried to mountain tops by the deluge described in the Bible. "If the shells had been carried by the muddy waters of the deluge", he wrote, "they would have been mixed up, and separated from each other amidst the mud, and not in regular steps and layers." Nor did Leonardo agree with the opinion that the shells somehow grew within the rocks: "Such an opinion cannot exist in a brain of much reason", he wrote, "because here are the years of their growth, numbered on their shells, and there are large and small ones to be seen, which could not have grown without food, and could not have fed without motion...and here they could not move."

Leonardo believed that the fossil shells were once part of living organisms, that they were buried in strata under water, and much later lifted to the tops of mountains by geological upheavals. However his acute observations had little influence on the opinions of his contemporaries because they appear among the 4000 or so pages of notes which he wrote for himself but never published.

It was left to the Danish scientist Niels Stensen (1638-1686) (usually known by his Latinized name, Steno) to independently rediscover and popularize the correct interpretation of fossils and of rock strata. Steno, who had studied medicine at the University of Leiden, was working in Florence, where his anatomical studies attracted the attention of the Grand Duke of Tuscany, Ferdinand II. When an enormous shark was caught by local fishermen, the Duke ordered that its head be brought to Steno for dissection. The Danish anatomist was struck by shape of the shark's teeth, which reminded him of certain curiously shaped stones called glossopetrae that were sometimes found embedded in larger rocks. Steno concluded that the similarity of form was not just a coincidence, and that the glossopetrae were in fact the teeth of once-living sharks which had become embedded in the muddy sediments at the bottom of the sea and gradually changed to stone. Steno used the corpuscular theory of matter, a forerunner of atomic theory, to explain how the composition of the fossils could have changed while their form remained constant. Steno also formulated a law of strata, which states that in the deposition of layers of sediment, later converted to rock, the oldest layers are at the bottom.

In England, the brilliant and versatile experimental scientist Robert Hooke (1635-1703) added to Steno's correct interpretation of fossils by noticing that some fossil species are not represented by any living counterparts. He concluded that "there have been many other Species of Creatures in former Ages, of which we can find none at present; and that 'tis not unlikely also but that there may be divers new kinds now, which have not been from the beginning."

Similar observations were made by the French naturalist, Georges-Louis Leclerc, Comte de Buffon (1707-1788), who wrote: "We have monuments taken from the bosom of the Earth, especially from the bottom of coal and slate mines, that demonstrate to us that some of the fish and plants that these materials contain do not belong to species currently existing." Buffon's position as keeper of the Jardin du Roi, the French botanical gardens, allowed him time for writing, and while holding this post he produced a 44-volume encyclopedia of natural history. In this enormous, clearly written, and popular work, Buffon challenged the theological doctrines which maintained that all species were created independently, simultaneously and miraculously, 6000 years ago. As evidence that species change, Buffon pointed to vestigial organs, such as the lateral toes of the pig, which may have had a use for the ancestors of the pig. He thought that the donkey might be a degenerate relative of the horse. Buffon believed the earth to be much older than the 6000 years allowed by the Bible, but his estimate, 75,000 years, greatly underestimated the true age of the earth.

The great Scottish geologist James Hutton (1726-1797) had a far more realistic picture of the true age of the earth. Hutton observed that some rocks seemed to have been produced by the compression of sediments laid down under water, while other rocks appeared to have hardened after previous melting. Thus he classified rocks as being either igneous or else sedimentary. He believed the features of the earth to have been produced by the slow action of wind, rain, earthquakes and other forces which can be observed today, and that these forces never acted with greater speed than they do now. This implied that the earth must be immensely old, and Hutton thought its age to be almost infinite. He believed that the forces which turned sea beds into mountain ranges drew their energy from the heat of the earth's molten core. Together with Steno, Hutton is considered to be one of the fathers of modern geology. His uniformitarian principles, and his belief in the great age of the earth were later given wide circulation by Charles Darwin's friend and mentor, Sir Charles Lyell (1797-1875), and they paved the way for Darwin's application of uniformitarianism to biology. At the time of his death, Hutton was working on a theory of biological evolution through natural selection, but his manuscripts on this subject remained unknown until 1946

Linnaeus, Lamarck and Erasmus Darwin

During the 17th and 18th centuries, naturalists had been gathering information on thousands of species of plants and animals. This huge, undigested heap of information was put into some order by the great Swedish naturalist, Carl von Linné (1707-1778), who is usually called by his Latin name, Carolus Linnaeus.

Linnaeus reclassified all living things, and he introduced a binomial nomenclature, so that each plant or animal became known by two names - the name of its genus, and the name of its species. In the classification of Linnaeus, the species within a given genus resemble each other very closely. Linnaeus also grouped related genera into classes, and related classes into orders. Later, the French anatomist, Cuvier (1769-1832), grouped related orders into phyla.

In France, the Chevalier J.B. de Lamarck (1744-1829), was struck by the close relationships between various animal species; and in 1809 he published a book entitled *Philosophie Zoologique*, in which he tried to explain this interrelatedness in terms of a theory of evolution. Lamarck explained the close similarity of the species within a genus by supposing these species to have evolved from a common ancestor. However, the mechanism of evolution which he postulated was seriously wrong, since he believed that acquired characteristics could be inherited.

Lamarck believed, for example, that giraffes stretched their necks slightly by reaching upward to eat the leaves of high trees. He believed that these slightly-stretched necks could be inherited; and in this way, Lamarck thought, the necks of giraffes have gradually become longer over many generations. Although his belief in the inheritability of acquired characteristics was a serious mistake, Lamarck deserves much credit for correctly maintaining that the close similarity between the species of a genus is due to their descent from a common ancestral species.

Meanwhile, in England, the brilliant physician-poet, Erasmus Darwin (1731-1802), who was considered by Coleridge to have "...a greater range of knowledge than any other man in Europe", had published *The Botanic Garden* and *Zoonomia* (1794). Darwin's first book, *The Botanic Garden*, was written in verse, and in the preface he stated that his purpose was "...to inlist imagination under the banner of science.." and to call the reader's attention to "the immortal works of the celebrated Swedish naturalist, Linnaeus". This book was immensely popular during Darwin's lifetime, but modern readers might find themselves wishing that he had used prose instead of poetry.

Darwin's second book, *Zoonomia*, is more interesting, since it contains a clear statement of the theory of evolution:

"...When we think over the great changes introduced into various animals", Darwin wrote, "as in horses, which we have exercised for different purposes of strength and swiftness, carrying burthens or in running races; or in dogs, which have been cultivated for strength and courage, as the bull-dog; or for acuteness of his sense of smell, as in the hound and spaniel; or for the swiftness of his feet, as the greyhound; or for his swimming in the water, or for drawing snow-sledges, as the rough-haired dogs of the north... and add to these the great change of shape and colour which we daily see produced in smaller animals from our domestication of them, as rabbits or pigeons;... when we revolve in our minds the great similarity of structure which obtains in all the warm-blooded animals, as well as quadrupeds, birds and amphibious animals, as in mankind, from the mouse and the bat to the elephant and whale; we are led to conclude that they have alike been produced from a similar living filament."

Erasmus Darwin's son, Robert, married Suzannah Wedgwood, the pretty and talented

daughter of the famous potter, Josiah Wedgwood; and in 1809, (the same year in which Lamarck published his *Philosophie Zoologique*), she became the mother of Charles Darwin.

Charles Darwin

As a boy, Charles Darwin was fond of collecting and hunting, but he showed no special ability in school. His father, disappointed by his mediocre performance, once said to him: “You care for nothing but shooting, dogs and rat-catching; and you will be a disgrace to yourself, and to all your family.”

Robert Darwin was determined that his son should not turn into an idle, sporting man, as he seemed to be doing, and when Charles was sixteen, he was sent to the University of Edinburgh to study medicine. However, Charles Darwin had such a sensitive and gentle disposition that he could not stand to see operations (performed, in those days, without chloroform). Besides, he had found out that his father planned to leave him enough money to live on comfortably; and consequently he didn't take his medical studies very seriously. However, some of his friends were scientists, and through them, Darwin became interested in geology and zoology.

Robert Darwin realized that his son did not want to become a physician, and, as an alternative, he sent Charles to Cambridge to prepare for the clergy. At Cambridge, Charles Darwin was very popular because of his cheerful, kind and honest character; but he was not a very serious student. Among his many friends, however, there were a few scientists, and they had a strong influence on him. The most important of Darwin's scientific friends were John Stevens Henslow, the Professor of Botany at Cambridge, and Adam Sedgwick, the Professor of Geology.

Remembering the things which influenced him at that time, Darwin wrote:

“During my last year at Cambridge, I read with care and profound interest Humboldt's *Personal Narrative of Travels to the Equinoctial Regions of America*. This work, and Sir J. Herschel's *Introduction to the Study of Natural Philosophy*, stirred up in me a burning desire to add even the most humble contribution to the noble structure of Natural Science. No one of a dozen books influenced me nearly so much as these. I copied out from Humboldt long passages about Teneriffe, and read them aloud to Henslow, Ramsay and Dawes... and some of the party declared that they would endeavour to go there; but I think they were only half in earnest. I was, however, quite in earnest, and got an introduction to a merchant in London to enquire about ships.”

During the summer of 1831, Charles Darwin went to Wales to help Professor Sedgwick, who was studying the extremely ancient rock formations found there. When he returned to his father's house after this geological expedition, he found a letter from Henslow. This letter offered Darwin the post of unpaid naturalist on the *Beagle*, a small brig which was being sent by the British government to survey the coast of South America and to carry a chain of chronological measurements around the world.

Darwin was delighted and thrilled by this offer. He had a burning desire both to visit the glorious, almost-unknown regions described by his hero, Alexander von Humboldt, and to “add even the most humble contribution to the noble structure of Natural Science”.



Figure 2.12: Erasmus Darwin (1731-1802), the grandfather of Charles Darwin, proposed a theory of evolution, but did not support it with enough experimental evidence to satisfy the naturalists of the time.

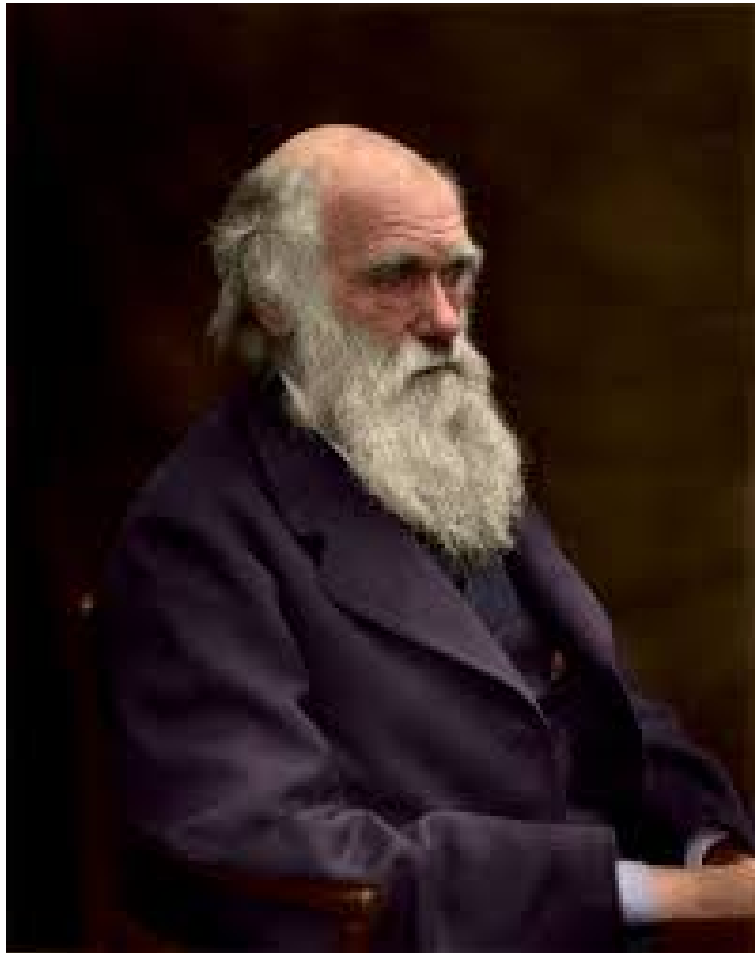

Figure 2.13: Charles Darwin (1809-1882) as an old man,

His hopes and plans were blocked, however, by the opposition of his father, who felt that Charles was once again changing his vocation and drifting towards a life of sport and idleness. "If you can find any man of common sense who advises you to go", Robert Darwin told his son, "I will give my consent".

Deeply depressed by his father's words, Charles Darwin went to visit the estate of his uncle, Josiah Wedgwood, at Maer, where he always felt more comfortable than he did at home. In Darwin's words what happened next was the following:

"...My uncle sent for me, offering to drive me over to Shrewsbury and talk with my father, as my uncle thought that it would be wise in me to accept the offer. My father always maintained that my uncle was one of the most sensible men in the world, and he at once consented in the kindest possible manner. I had been rather extravagant while at Cambridge, and to console my father, I said that 'I should be deuced clever to spend more than my allowance whilst on board the *Beagle*', but he answered with a smile, 'But they tell me you are very clever!'"

Thus, on December 27, 1831, Charles Darwin started on a five-year voyage around the world. Not only was this voyage destined to change Darwin's life, but also, more importantly, it was destined to change man's view of his place in nature.

Lyell's hypothesis

As the *Beagle* sailed out of Devonport in gloomy winter weather, Darwin lay in his hammock, 22 years old, miserably seasick and homesick, knowing that he would not see his family and friends for many years. To take his mind away from his troubles, Darwin read a new book, which Henslow had recommended: Sir Charles Lyell's *Principles of Geology*. "Read it by all means", Henslow had written, "for it is very interesting; but do not pay any attention to it except in regard to facts, for it is altogether wild as far as theory goes."

Reading Lyell's book with increasing excitement and absorption, Darwin could easily see what Henslow found objectionable: Lyell, a follower of the great Scottish geologist, James Hutton (1726-1797), introduced a revolutionary hypothesis into geology. According to Lyell, "No causes whatever have, from the earliest times to which we can look back, to the present, ever acted, but those now acting; and they have never acted with different degrees of energy from those which they now exert".

This idea seemed dangerous and heretical to deeply religious men like Henslow and Sedgwick. They believed that the earth's geology had been shaped by Noah's flood, and perhaps by other floods and catastrophes which had occurred before the time of Noah. The great geological features of the earth, its mountains, valleys and planes, they viewed as marks left behind by the various catastrophes through which the earth had passed.

All this was now denied by Lyell. He believed the earth to be enormously old - thousands of millions of years old. Over this vast period of time, Lyell believed, the long-continued action of slow forces had produced the geological features of the earth. Great valleys had been carved out by glaciers and by the slow action of rain and frost; and gradual changes in the level of the land, continued over enormous periods of time, had built up towering mountain ranges.

Lyell's belief in the immense age of the earth, based on geological evidence, made the evolutionary theories of Darwin's grandfather suddenly seem more plausible. Given such vast quantities of time, the long-continued action of small forces might produce great changes in biology as well as in geology!

By the time the *Beagle* had reached San Thiago in the Cape Verde Islands, Darwin had thoroughly digested Lyell's book, with its dizzying prospects. Looking at the geology of San Thiago, he realized "the wonderful superiority of Lyell's manner of treating geology". Features of the island which would have been incomprehensible on the basis of the usual Catastrophist theories were clearly understandable on the basis of Lyell's hypothesis.

As the *Beagle* slowly made its way southward along the South American coast, Darwin went on several expeditions to explore the interior. On one of these trips, he discovered some fossil bones in the red mud of a river bed. He carefully excavated the area around them, and found the remains of nine huge extinct quadrupeds. Some of them were as large as elephants, and yet in structure they seemed closely related to living South American species. For example, one of the extinct animals which Darwin discovered resembled an armadillo except for its gigantic size.

The *Beagle* rounded Cape Horn, lashed by freezing waves so huge that it almost floundered. After the storm, when the brig was anchored safely in the channel of Tierra del Fuego, Darwin noticed how a Fuegian woman stood for hours and watched the ship, while sleet fell and melted on her naked breast, and on the new-born baby she was nursing. He was struck by the remarkable degree to which the Fuegians had adapted to their frigid environment, so that they were able to survive with almost no shelter, and with no clothes except a few stiff animal skins, which hardly covered them, in weather which would have killed ordinary people.

In 1835, as the *Beagle* made its way slowly northward, Darwin had many chances to explore the Chilean coast - a spectacularly beautiful country, shadowed by towering ranges of the Andes. One day, near Concepcion Bay, he experienced the shocks of a severe earthquake.

"It came on suddenly, and lasted two minutes", Darwin wrote, "The town of Concepcion is now nothing more than piles and lines of bricks, tiles and timbers."

Measurements which Darwin made showed him that the shoreline near Concepcion had risen at least three feet during the quake; and thirty miles away, Fitzroy, the captain of the *Beagle*, discovered banks of mussels ten feet above the new high-water mark. This was dramatic confirmation of Lyell's theories! After having seen how much the level of the land was changed by a single earthquake, it was easy for Darwin to imagine that similar events, in the course of many millions of years, could have raised the huge wall of the Andes mountains.

In September, 1835, the *Beagle* sailed westward to the Galapagos Islands, a group of small rocky volcanic islands off the coast of Peru. On these islands, Darwin found new species of plants and animals which did not exist anywhere else in the world. In fact, he discovered that each of the islands had its own species, similar to the species found on the other islands, but different enough to be classified separately.

The Galapagos Islands contained thirteen species of finches, found nowhere else in the

world, all basically alike in appearance, but differing in certain features especially related to their habits and diet. As he turned these facts over in his mind, it seemed to Darwin that the only explanation was that the thirteen species of Galapagos finches were descended from a single species, a few members of which had been carried to the islands by strong winds blowing from the South American mainland.

“Seeing this gradation and diversity of structure in one small, intimately related group of birds”, Darwin wrote, “one might really fancy that from an original paucity of birds in this archipelago, one species had been taken and modified for different ends... Facts such as these might well undermine the stability of species.”

As Darwin closely examined the plants and animals of the Galapagos Islands, he could see that although they were not quite the same as the corresponding South American species, they were so strongly similar that it seemed most likely that all the Galapagos plants and animals had reached the islands from the South American mainland, and had since been modified to their present form.

The idea of the gradual modification of species could also explain the fact, observed by Darwin, that the fossil animals of South America were more closely related to African and Eurasian animals than were the living South American species. In other words, the fossil animals of South America formed a link between the living South American species and the corresponding animals of Europe, Asia and Africa. The most likely explanation for this was that the animals had crossed to America on a land bridge which had since been lost, and that they had afterwards been modified.

The Beagle continued its voyage westward, and Darwin had a chance to study the plants and animals of the Pacific Islands. He noticed that there were no mammals on these islands, except bats and a few mammals brought by sailors. It seemed likely to Darwin that all the species of the Pacific Islands had reached them by crossing large stretches of water after the volcanic islands had risen from the ocean floor; and this accounted for the fact that so many classes were missing. The fact that each group of islands had its own particular species, found nowhere else in the world, seemed to Darwin to be strong evidence that the species had been modified after their arrival. The strange marsupials of the isolated Australian continent also made a deep impression on Darwin.

The Origin of Species

Darwin had left England on the Beagle in 1831, an immature young man of 22, with no real idea of what he wanted to do with his life. He returned from the five-year voyage in 1836, a mature man, confirmed in his dedication to science, and with formidable powers of observation, deduction and generalization. Writing of the voyage, Darwin says:

“I have always felt that I owe to the voyage the first real education of my mind... Everything about which I thought or read was made to bear directly on what I had seen, or was likely to see, and this habit was continued during the five years of the voyage. I feel sure that it was this training which has enabled me to do whatever I have done in science.”

Darwin returned to England convinced by what he had seen on the voyage that plant and animal species had not been independently and miraculously created, but that they

had been gradually modified to their present form over millions of years of geological time.

Darwin was delighted to be home and to see his family and friends once again. To his uncle, Josiah Wedgwood, he wrote:

“My head is quite confused from so much delight, but I cannot allow my sister to tell you first how happy I am to see all my dear friends again... I am most anxious once again to see Maer and all its inhabitants.”

In a letter to Henslow, he said:

“My dear Henslow, I do long to see you. You have been the kindest friend to me that ever man possessed. I can write no more, for I am giddy with joy and confusion.”

In 1837, Darwin took lodgings at Great Marlborough Street in London, where he could work on his geological and fossil collections. He was helped in his work by Sir Charles Lyell, who became Darwin's close friend. In 1837 Darwin also began a notebook on *Transmutation of Species*. His *Journal of researches into the geology and natural history of the various countries visited by the H.M.S. Beagle* was published in 1839, and it quickly became a best-seller. It is one of the most interesting travel books ever written, and since its publication it has been reissued more than a hundred times.

These were very productive years for Darwin, but he was homesick, both for his father's home at the Mount and for his uncle's nearby estate at Maer, with its galaxy of attractive daughters. Remembering his many happy visits to Maer, he wrote:

“In the summer, the whole family used often to sit on the steps of the old portico, with the flower-garden in front, and with the steep, wooded bank opposite the house reflected in the lake, with here and there a fish rising, or a water-bird paddling about. Nothing has left a more vivid picture in my mind than these evenings at Maer.”

In the summer of 1838, tired of his bachelor life in London, Darwin wrote in his diary:

“My God, it is intolerable to think of spending one's whole life like a neuter bee, working, working, and nothing after all! Imagine living all one's days in smoky, dirty London! Only picture to yourself a nice soft wife on a sofa with a good fire, and books and music perhaps.. Marry! Marry! Marry! Q.E.D.”

Having made this decision, Darwin went straight to Maer and proposed to his pretty cousin, Emma Wedgwood, who accepted him at once, to the joy of both families. Charles and Emma Darwin bought a large and pleasant country house at Down, fifteen miles south of London; and there, in December, 1839, the first of their ten children was born.

Darwin chose this somewhat isolated place for his home because he was beginning to show signs of a chronic illness, from which he suffered for the rest of his life. His strength was very limited, and he saved it for his work by avoiding social obligations. His illness was never accurately diagnosed during his own lifetime, but the best guess of modern doctors is that he had Chagas' disease, a trypanosome infection transmitted by the bite of a South American blood-sucking bug.

Darwin was already convinced that species had changed over long periods of time, but what were the forces which caused this change? In 1838 he found the answer:

“I happened to read for amusement Malthus on *Population*”, he wrote, “and being well prepared to appreciate the struggle for existence which everywhere goes on from long-

continued observation of the habits of animals and plants, it at once struck me that under these circumstances favorable variations would tend to be preserved, and unfavorable ones destroyed. The result would be the formation of new species”

“Here, then, I had at last got a theory by which to work; but I was so anxious to avoid prejudice that I determined not for some time to write down even the briefest sketch of it. In June, 1842, I first allowed myself the satisfaction of writing a very brief abstract of my theory in pencil in 33 pages; and this was enlarged during the summer of 1844 into one of 230 pages”.

All of Darwin’s revolutionary ideas were contained in the 1844 abstract, but he did not publish it! Instead, in an incredible Copernicus-like procrastination, he began a massive treatise on barnacles, which took him eight years to finish! Probably Darwin had a premonition of the furious storm of hatred and bigotry which would be caused by the publication of his heretical ideas.

Finally, in 1854, he wrote to his friend, Sir Joseph Hooker (the director of Kew Botanical Gardens), to say that he was at last resuming his work on the origin of species. Both Hooker and Lyell knew of Darwin’s work on evolution, and for many years they had been urging him to publish it. By 1835, he had written eleven chapters of a book on the origin of species through natural selection; but he had begun writing on such a vast scale that the book might have run to four or five heavy volumes, which could have taken Darwin the rest of his life to complete.

Fortunately, this was prevented by the arrival at Down House of a bombshell in the form of a letter from a young naturalist named Alfred Russell Wallace. Like Darwin, Wallace had read Malthus’ book *On Population*, and in a flash of insight during a period of fever in Malaya, he had arrived at a theory of evolution through natural selection which was precisely the same as the theory on which Darwin had been working for twenty years! Wallace enclosed with his letter a short paper entitled *On the Tendency of Varieties to Depart Indefinitely From the Original Type*. It was a perfect summary of Darwin’s theory of evolution!

“I never saw a more striking coincidence”, the stunned Darwin wrote to Lyell, “If Wallace had my MS. sketch, written in 1842, he could not have made a better short abstract! Even his terms now stand as heads of my chapters... I should be extremely glad now to publish a sketch of my general views in about a dozen pages or so; but I cannot persuade myself that I can do so honourably... I would far rather burn my whole book than that he or any other man should think that I have behaved in a paltry spirit.”

Both Lyell and Hooker acted quickly and firmly to prevent Darwin from suppressing his own work, as he was inclined to do. In the end, they found a happy solution: Wallace’s paper was read to the Linnean Society together with a short abstract of Darwin’s work, and the two papers were published together in the proceedings of the society. The members of the Society listened in stunned silence. As Hooker wrote to Darwin the next day, the subject was “too novel and too ominous for the old school to enter the lists before armouring.”

Lyell and Hooker then persuaded Darwin to write a book of moderate size on evolution through natural selection. As a result, in 1859, he published *The Origin of Species*, which

ranks, together with Newton's *Principia* as one of the two greatest scientific books of all time. What Newton did for physics, Darwin did for biology: He discovered the basic theoretical principle which brings together all the experimentally-observed facts and makes them comprehensible; and he showed in detail how this basic principle can account for the facts in a very large number of applications.

2.3 Modern theories of the origin of life

Molecular biology

Charles Darwin postulated that natural selection acts on small inheritable variations in the individual members of a species. His opponents objected that these slight variations would be averaged away by interbreeding. Darwin groped after an answer to this objection, but he did not have one. However, unknown to Darwin, the answer had been uncovered several years earlier by an obscure Augustinian monk, Gregor Mendel, who was born in Silesia in 1822, and who died in Bohemia in 1884.

Mendel loved both botany and mathematics, and he combined these two interests in his hobby of breeding peas in the monastery garden. Mendel carefully self-pollinated his pea plants, and then wrapped the flowers to prevent pollination by insects. He kept records of the characteristics of the plants and their offspring, and he found that dwarf peas always breed true - they invariably produce other dwarf plants. The tall variety of pea plants, pollinated with themselves, did not always breed true, but Mendel succeeded in isolating a strain of true-breeding tall plants which he inbred over many generations.

Next he crossed his true-breeding tall plants with the dwarf variety and produced a generation of hybrids. All of the hybrids produced in this way were tall. Finally Mendel self-pollinated the hybrids and recorded the characteristics of the next generation. Roughly one quarter of the plants in this new generation were true-breeding tall plants, one quarter were true-breeding dwarfs, and one half were tall but not true-breeding.

Gregor Mendel had in fact discovered the existence of dominant and recessive genes. In peas, dwarfism is a recessive characteristic, while tallness is dominant. Each plant has two sets of genes, one from each parent. Whenever the gene for tallness is present, the plant is tall, regardless of whether it also has a gene for dwarfism. When Mendel crossed the pure-breeding dwarf plants with pure-breeding tall ones, the hybrids received one type of gene from each parent. Each hybrid had a tall gene and a dwarf gene; but the tall gene was dominant, and therefore all the hybrids were tall. When the hybrids were self-pollinated or crossed with each other, a genetic lottery took place. In the next generation, through the laws of chance, a quarter of the plants had two dwarf genes, a quarter had two tall genes, and half had one of each kind.

Mendel published his results in the *Transactions of the Brünn Natural History Society* in 1865, and no one noticed his paper². At that time, Austria was being overrun by the

² Mendel sent a copy of his paper to Darwin; but Darwin, whose German was weak, seems not to have read it.

Prussians, and people had other things to think about. Mendel was elected Abbot of his monastery; he grew too old and fat to bend over and cultivate his pea plants; his work on heredity was completely forgotten, and he died never knowing that he would one day be considered to be the founder of modern genetics.

In 1900 the Dutch botanist named Hugo de Vries, working on evening primroses, independently rediscovered Mendel's laws. Before publishing, he looked through the literature to see whether anyone else had worked on the subject, and to his amazement he found that Mendel had anticipated his great discovery by 35 years. De Vries could easily have published his own work without mentioning Mendel, but his honesty was such that he gave Mendel full credit and mentioned his own work only as a confirmation of Mendel's laws. Astonishingly, the same story was twice repeated elsewhere in Europe during the same year. In 1900, two other botanists (Correns in Berlin and Tschermak in Vienna) independently rediscovered Mendel's laws, looked through the literature, found Mendel's 1865 paper, and gave him full credit for the discovery.

Besides rediscovering the Mendelian laws for the inheritance of dominant and recessive characteristics, de Vries made another very important discovery: He discovered genetic mutations - sudden unexplained changes of form which can be inherited by subsequent generations. In growing evening primroses, de Vries found that sometimes, but very rarely, a completely new variety would suddenly appear, and he found that the variation could be propagated to the following generations. Actually, mutations had been observed before the time of de Vries. For example, a short-legged mutant sheep had suddenly appeared during the 18th century; and stock-breeders had taken advantage of this mutation to breed sheep that could not jump over walls. However, de Vries was the first scientist to study and describe mutations. He noticed that most mutations are harmful, but that a very few are beneficial, and those few tend in nature to be propagated to future generations.

After the rediscovery of Mendel's work by de Vries, many scientists began to suspect that chromosomes might be the carriers of genetic information. The word "chromosome" had been invented by the German physiologist, Walther Flemming, to describe the long, threadlike bodies which could be seen when cells were stained and examined through the microscope during the process of division. It had been found that when an ordinary cell divides, the chromosomes also divide, so that each daughter cell has a full set of chromosomes.

The Belgian cytologist, Edouard van Benedin, had shown that in the formation of sperm and egg cells, the sperm and egg receive only half of the full number of chromosomes. It had been found that when the sperm of the father combines with the egg of the mother in sexual reproduction, the fertilized egg again has a full set of chromosomes, half coming from the mother and half from the father. This was so consistent with the genetic lottery studied by Mendel, de Vries and others, that it seemed almost certain that chromosomes were the carriers of genetic information.

The number of chromosomes was observed to be small (for example, each normal cell of a human has 46 chromosomes); and this made it obvious that each chromosome must contain thousands of genes. It seemed likely that all of the genes on a particular chromosome would stay together as they passed through the genetic lottery; and therefore certain

characteristics should always be inherited together.

This problem had been taken up by Thomas Hunt Morgan, a professor of experimental zoology working at Columbia University. He found it convenient to work with fruit flies, since they breed with lightning-like speed and since they have only four pairs of chromosomes.

Morgan found that he could raise enormous numbers of these tiny insects with almost no effort by keeping them in gauze-covered glass milk bottles, in the bottom of which he placed mashed bananas. In 1910, Morgan found a mutant white-eyed male fly in one of his milk-bottle incubators. He bred this fly with a normal red-eyed female, and produced hundreds of red-eyed hybrids. When he crossed the red-eyed hybrids with each other, half of the next generation were red-eyed females, a quarter were red-eyed males, and a quarter were white-eyed males. There was not one single white-eyed female! This indicated that the mutant gene for white eyes was on the same chromosome as the gene for the male sex.

As Morgan continued his studies of genetic linkages, however, it became clear that the linkages were not absolute. There was a tendency for all the genes on the same chromosome to be inherited together; but on rare occasions there were “crosses”, where apparently a pair of chromosomes broke at some point and exchanged segments. By studying these crosses statistically, Morgan and his “fly squad” were able to find the relative positions of genes on the chromosomes. They reasoned that the probability for a cross to separate two genes should be proportional to the distance between the two genes on the chromosome. In this way, after 17 years of work and millions of fruit flies, Thomas Hunt Morgan and his coworkers were able to make maps of the fruit fly chromosomes showing the positions of the genes.

This work had been taken a step further by Hermann J. Muller, a member of Morgan’s “fly squad”, who exposed hundreds of fruit flies to X-rays. The result was a spectacular outbreak of man-made mutations in the next generation.

“They were a motley throng”, recalled Muller. Some of the mutant flies had almost no wings, others bulging eyes, and still others brown, yellow or purple eyes; some had no bristles, and others curly bristles. Muller’s experiments indicated that mutations can be produced by radiation-induced physical damage; and he guessed that such damage alters the chemical structure of genes.

In spite of the brilliant work by Morgan and his collaborators, no one had any idea of what a gene really was.

The structure of DNA

Until 1944, most scientists had guessed that the genetic message was carried by the proteins of the chromosome. In 1944, however, O.T. Avery and his co-workers at the laboratory of the Rockefeller Institute in New York performed a critical experiment, which proved that the material which carries genetic information is not protein, but deoxyribonucleic acid (DNA) - a giant chainlike molecule which had been isolated from cell nuclei by the Swiss chemist, Friedrich Miescher.

Avery had been studying two different strains of pneumococci, the bacteria which cause pneumonia. One of these strains, the S-type, had a smooth coat, while the other strain, the R-type, lacked an enzyme needed for the manufacture of a smooth carbohydrate coat. Hence, R-type pneumococci had a rough appearance under the microscope. Avery and his co-workers were able to show that an extract from heat-killed S-type pneumococci could convert the living R-type species permanently into S-type; and they also showed that this extract consisted of pure DNA.

In 1947, the Austrian-American biochemist, Erwin Chargaff, began to study the long, chainlike DNA molecules. It had already been shown by Levine and Todd that chains of DNA are built up of four bases: adenine (A), thymine (T), guanine (G) and cytosine (C), held together by a sugar-phosphate backbone. Chargaff discovered that in DNA from the nuclei of living cells, the amount of A always equals the amount of T; and the amount of G always equals the amount of C.

When Chargaff made this discovery, neither he nor anyone else understood its meaning. However, in 1953, the mystery was completely solved by Rosalind Franklin and Maurice Wilkins at Kings College, London, together with James Watson and Francis Crick at Cambridge University. By means of X-ray diffraction techniques, Wilkins and Franklin obtained crystallographic information about the structure of DNA. Using this information, together with Linus Pauling's model-building methods, Crick and Watson proposed a detailed structure for the giant DNA molecule.

The discovery of the molecular structure of DNA was an event of enormous importance for genetics, and for biology in general. The structure was a revelation! The giant, helical DNA molecule was like a twisted ladder: Two long, twisted sugar-phosphate backbones formed the outside of the ladder, while the rungs were formed by the base pairs, A, T, G and C. The base adenine (A) could only be paired with thymine (T), while guanine (G) fit only with cytosine (C). Each base pair was weakly joined in the center by hydrogen bonds - in other words, there was a weak point in the center of each rung of the ladder - but the bases were strongly attached to the sugar-phosphate backbone. In their 1953 paper, Crick and Watson wrote:

"It has not escaped our notice that the specific pairing we have postulated suggests a possible copying mechanism for genetic material". Indeed, a sudden blaze of understanding illuminated the inner workings of heredity, and of life itself.

If the weak hydrogen bonds in the center of each rung were broken, the ladderlike DNA macromolecule could split down the center and divide into two single strands. Each single strand would then become a template for the formation of a new double-stranded molecule.

Because of the specific pairing of the bases in the Watson-Crick model of DNA, the two strands had to be complementary. T had to be paired with A, and G with C. Therefore, if the sequence of bases on one strand was (for example) TTTGCTAAAGGTGAACCA... , then the other strand necessarily had to have the sequence AAACGATTTCCACTTGGT... The Watson-Crick model of DNA made it seem certain that all the genetic information needed for producing a new individual is coded into the long, thin, double-stranded DNA molecule of the cell nucleus, written in a four-letter language whose letters are the bases, adenine, thymine, guanine and cytosine.

The solution of the DNA structure in 1953 initiated a new kind of biology - molecular biology. This new discipline made use of recently-discovered physical techniques - X-ray diffraction, electron microscopy, electrophoresis, chromatography, ultracentrifugation, radioactive tracer techniques, autoradiography, electron spin resonance, nuclear magnetic resonance and ultraviolet spectroscopy. In the 1960's and 1970's, molecular biology became the most exciting and rapidly-growing branch of science.

Protein structure

In England, J.D. Bernal and Dorothy Crowfoot Hodgkin pioneered the application of X-ray diffraction methods to the study of complex biological molecules. In 1949, Hodgkin determined the structure of penicillin; and in 1955, she followed this with the structure of vitamin B12. In 1960, Max Perutz and John C. Kendrew obtained the structures of the blood proteins myoglobin and hemoglobin. This was an impressive achievement for the Cambridge crystallographers, since the hemoglobin molecule contains roughly 12,000 atoms.

The structure obtained by Perutz and Kendrew showed that hemoglobin is a long chain of amino acids, folded into a globular shape, like a small, crumpled ball of yarn. They found that the amino acids with an affinity for water were on the outside of the globular molecule; while the amino acids for which contact with water was energetically unfavorable were hidden on the inside. Perutz and Kendrew deduced that the conformation of the protein - the way in which the chain of amino acids folded into a 3-dimensional structure - was determined by the sequence of amino acids in the chain.

In 1966, D.C. Phillips and his co-workers at the Royal Institution in London found the crystallographic structure of the enzyme lysozyme (an egg-white protein which breaks down the cell walls of certain bacteria). Again, the structure showed a long chain of amino acids, folded into a roughly globular shape. The amino acids with hydrophilic groups were on the outside, in contact with water, while those with hydrophobic groups were on the inside. The structure of lysozyme exhibited clearly an active site, where sugar molecules of bacterial cell walls were drawn into a mouth-like opening and stressed by electrostatic forces, so that bonds between the sugars could easily be broken.

Meanwhile, at Cambridge University, Frederick Sanger developed methods for finding the exact sequence of amino acids in a protein chain. In 1945, he discovered a compound (2,4-dinitrofluorobenzene) which attaches itself preferentially to one end of a chain of amino acids. Sanger then broke down the chain into individual amino acids, and determined which of them was connected to his reagent. By applying this procedure many times to fragments of larger chains, Sanger was able to deduce the sequence of amino acids in complex proteins. In 1953, he published the sequence of insulin. This led, in 1964, to the synthesis of insulin.

The biological role and structure of proteins which began to emerge was as follows: A mammalian cell produces roughly 10,000 different proteins. All enzymes are proteins; and the majority of proteins are enzymes - that is, they catalyze reactions involving other biological molecules. All proteins are built from chainlike polymers, whose monomeric sub-units are the following twenty amino acids: glycine, alanine, valine, isoleucine, leucine, serine,

threonine, proline, aspartic acid, glutamic acid, lysine, arginine, asparagine, glutamine, cysteine, methionine, tryptophan, phenylalanine, tyrosine and histidine. These individual amino acid monomers may be connected together into a polymer (called a polypeptide) in any order - hence the great number of possibilities. In such a polypeptide, the backbone is a chain of carbon and nitrogen atoms showing the pattern ...-C-C-N-C-C-N-C-C-N-...and so on. The -C-C-N- repeating unit is common to all amino acids. Their individuality is derived from differences in the side groups which are attached to the universal -C-C-N-group.

Some proteins, like hemoglobin, contain metal atoms, which may be oxidized or reduced as the protein performs its biological function. Other proteins, like lysozyme, contain no metal atoms, but instead owe their biological activity to an active site on the surface of the protein molecule. In 1909, the English physician, Archibald Garrod, had proposed a one-gene-one-protein hypothesis. He believed that hereditary diseases are due to the absence of specific enzymes. According to Garrod's hypothesis, damage suffered by a gene results in the faulty synthesis of the corresponding enzyme, and loss of the enzyme ultimately results in the symptoms of the hereditary disease.

In the 1940's, Garrod's hypothesis was confirmed by experiments on the mold, *Neurospora*, performed at Stanford University by George Beadle and Edward Tatum. They demonstrated that mutant strains of the mold would grow normally, provided that specific extra nutrients were added to their diets. The need for these dietary supplements could in every case be traced to the lack of a specific enzyme in the mutant strains. Linus Pauling later extended these ideas to human genetics by showing that the hereditary disease, sickle-cell anemia, is due to a defect in the biosynthesis of hemoglobin.

RNA and ribosomes

Since DNA was known to carry the genetic message, coded into the sequence of the four nucleotide bases, A, T, G and C, and since proteins were known to be composed of specific sequences of the twenty amino acids, it was logical to suppose that the amino acid sequence in a protein was determined by the base sequence of DNA. The information somehow had to be read from the DNA and used in the biosynthesis of the protein.

It was known that, in addition to DNA, cells also contain a similar, but not quite identical, polynucleotide called ribonucleic acid (RNA). The sugar-phosphate backbone of RNA was known to differ slightly from that of DNA; and in RNA, the nucleotide thymine (T) was replaced by a chemically similar nucleotide, uracil (U). Furthermore, while DNA was found only in cell nuclei, RNA was found both in cell nuclei and in the cytoplasm of cells, where protein synthesis takes place. Evidence accumulated indicating that genetic information is first transcribed from DNA to RNA, and afterwards translated from RNA into the amino acid sequence of proteins.

At first, it was thought that RNA might act as a direct template, to which successive amino acids were attached. However, the appropriate chemical complementarity could not be found; and therefore, in 1955, Francis Crick proposed that amino acids are first bound

to an adaptor molecule, which is afterward bound to RNA.

In 1956, George Emil Palade of the Rockefeller Institute used electron microscopy to study subcellular particles rich in RNA (ribosomes). Ribosomes were found to consist of two subunits - a smaller subunit, with a molecular weight one million times the weight of a hydrogen atom, and a larger subunit with twice this weight.

It was shown by means of radioactive tracers that a newly synthesized protein molecule is attached temporarily to a ribosome, but neither of the two subunits of the ribosome seemed to act as a template for protein synthesis. Instead, Palade and his coworkers found that genetic information is carried from DNA to the ribosome by a messenger RNA molecule (mRNA). Electron microscopy revealed that mRNA passes through the ribosome like a punched computer tape passing through a tape-reader. It was found that the adapter molecules, whose existence Crick had postulated, were smaller molecules of RNA; and these were given the name "transfer RNA" (tRNA). It was shown that, as an mRNA molecule passes through a ribosome, amino acids attached to complementary tRNA adaptor molecules are added to the growing protein chain.

The relationship between DNA, RNA, the proteins and the smaller molecules of a cell was thus seen to be hierarchical: The cell's DNA controlled its proteins (through the agency of RNA); and the proteins controlled the synthesis and metabolism of the smaller molecules.

The genetic code

In 1955, Severo Ochoa, at New York University, isolated a bacterial enzyme (RNA polymerase) which was able to join the nucleotides A, G, U and C so that they became an RNA strand. One year later, this feat was repeated for DNA by Arthur Kornberg.

With the help of Ochoa's enzyme, it was possible to make synthetic RNA molecules containing only a single nucleotide - for example, one could join uracil molecules into the ribonucleic acid chain, ...U-U-U-U-U-U-... In 1961, Marshall Nirenberg and Heinrich Matthaei used synthetic poly-U as messenger RNA in protein synthesis; and they found that only polyphenylalanine was synthesized. In the same year, Sydney Brenner and Francis Crick reported a series of experiments on mutant strains of the bacteriophage, T4. The experiments of Brenner and Crick showed that whenever a mutation added or deleted either one or two base pairs, the proteins produced by the mutants were highly abnormal and non-functional. However, when the mutation added or subtracted three base pairs, the proteins often were functional. Brenner and Crick concluded that the genetic language has three-letter words (codons). With four different "letters", A, T, G and C, this gives sixty-four possible codons - more than enough to specify the twenty different amino acids.

In the light of the phage experiments of Brenner and Crick, Nirenberg and Matthaei concluded that the genetic code for phenylalanine is UUU in RNA and TTT in DNA. The remaining words in the genetic code were worked out by H. Gobind Khorana of the University of Wisconsin, who used other mRNA sequences (such as GUGUGU..., AAGAA-GAAG... and GUUGUUGUU...) in protein synthesis. By 1966, the complete genetic code, specifying amino acids in terms of three-base sequences, was known. The code was found

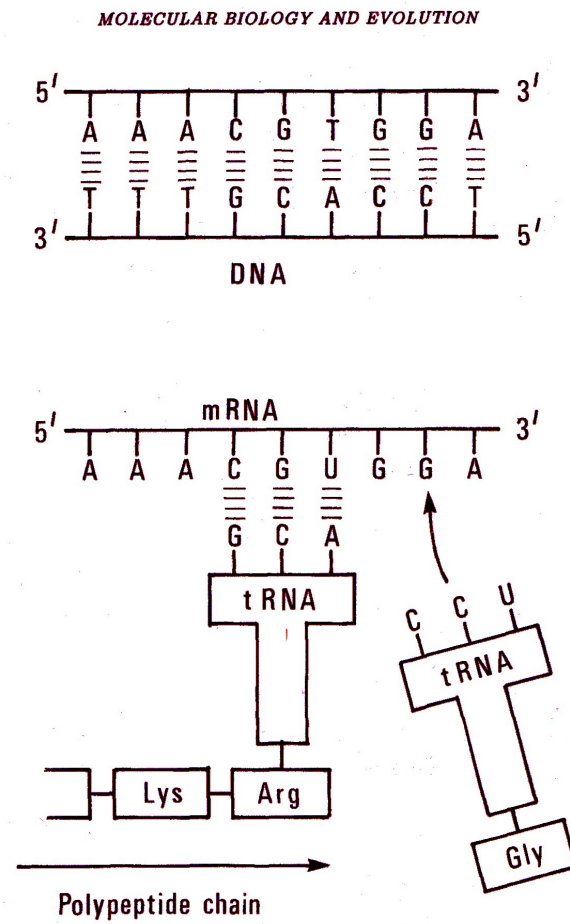

Figure 2.14: Information coded on DNA molecules in the cell nucleus is transcribed to mRNA molecules. The messenger RNA molecules in turn provide information for the amino acid sequence in protein synthesis.

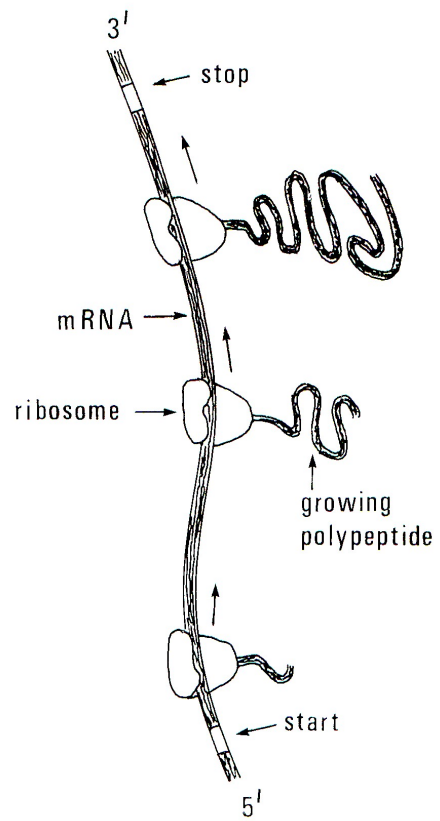

Figure 2.15: mRNA passes through the ribosome like a punched computer tape passing through a tape-reader.

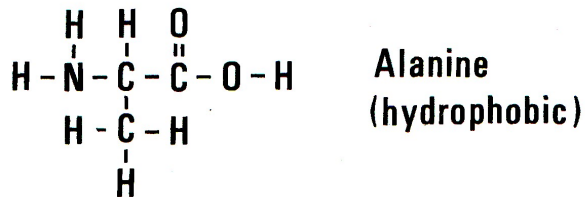
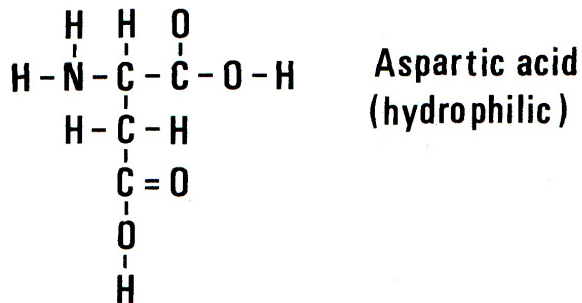
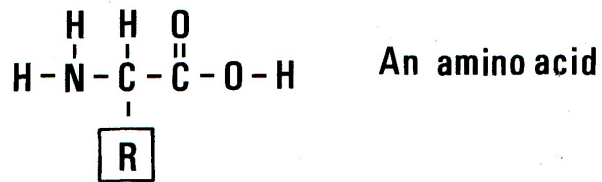

Figure 2.16: This figure shows aspartic acid, whose residue (R) is hydrophilic, contrasted with alanine, whose residue is hydrophobic.

Table 2.1: **The genetic code**

| | | | |
|---------|---------|---------|---------|
| TTT=Phe | TCT=Ser | TAT=Tyr | TGT=Cys |
| TTC=Phe | TCC=Ser | TAC=Tyr | TGC=Cys |
| TTA=Leu | TCA=Ser | TAA=Ter | TGA=Ter |
| TTG=Leu | TGC=Ser | TAG=Ter | TGG=Trp |
| CTT=Leu | CCT=Pro | CAT=His | CGT=Arg |
| CTC=Leu | CCC=Pro | CAC=His | CGC=Arg |
| CTA=Leu | CCA=Pro | CAA=Gln | CGA=Arg |
| CTG=Leu | CGC=Pro | CAG=Gln | CGG=Arg |
| ATT=Ile | ACT=Thr | AAT=Asn | AGT=Ser |
| ATC=Ile | ACC=Thr | AAC=Asn | AGC=Ser |
| ATA=Ile | ACA=Thr | AAA=Lys | AGA=Arg |
| ATG=Met | AGC=Thr | AAG=Lys | AGG=Arg |
| GTT=Val | GCT=Ala | GAT=Asp | GGT=Gly |
| GTC=Val | GCC=Ala | GAC=Asp | GGC=Gly |
| GTA=Val | GCA=Ala | GAA=Glu | GGA=Gly |
| GTG=Val | GGC=Ala | GAG=Glu | GGG=Gly |

to be the same for all species studied, no matter how widely separated they were in form; and this showed that all life on earth belongs to the same family, as postulated by Darwin.

Genetic engineering

In 1970, Hamilton Smith of Johns Hopkins University observed that when the bacterium *Haemophilus influenzae* is attacked by a bacteriophage (a virus parasitic on bacteria), it can defend itself by breaking down the DNA of the phage. Following up this observation, he introduced DNA from the bacterium *E. coli* into *H. influenzae*. Again the foreign DNA was broken down.

Smith had, in fact, discovered the first of a class of bacterial enzymes which came to be called “restriction enzymes” or “restriction nucleases”. Almost a hundred other restriction enzymes were subsequently discovered, and each was found to cut DNA at a specific base sequence. Smith’s colleague, Daniel Nathans, used the restriction enzymes *Hin* dII and *Hin* dIII to produce the first “restriction map” of the DNA in a virus.

In 1971 and 1972, Paul Berg, and his co-workers Peter Lobban, Dale Kaiser and David Jackson at Stanford University, developed methods for adding cohesive ends to DNA fragments. Berg and his group used the calf thymus enzyme, terminal transferase, to add short, single-stranded polynucleotide segments to DNA fragments. For example, if they added the single-stranded segment AAAA to one fragment, and TTTT to another, then

the two ends joined spontaneously when the fragments were incubated together. In this way Paul Berg and his group made the first recombinant DNA molecules.

The restriction enzyme Eco RI, isolated from the bacterium *E. coli*, was found to recognize the pattern, GAATTC, in one strand of a DNA molecule, and the complementary pattern, CTTAAG, in the other strand. Instead of cutting both strands in the middle of the six-base sequence, Eco RI was observed to cut both strands between G and A. Thus, each side of the cut was left with a “sticky end” - a five-base single-stranded segment, attached to the remainder of the double-stranded DNA molecule.

In 1972, Janet Mertz and Ron Davis, working at Stanford University, demonstrated that DNA strands cut with Eco RI could be rejoined by means of another enzyme - a DNA ligase. More importantly, when DNA strands from two different sources were cut with Eco RI, the sticky end of one fragment could form a spontaneous temporary bond with the sticky end of the other fragment. The bond could be made permanent by the addition of DNA ligase, even when the fragments came from different sources. Thus, DNA fragments from different organisms could be joined together.

Bacteria belong to a class of organisms (prokaryotes) whose cells do not have a nucleus. Instead, the DNA of the bacterial chromosome is arranged in a large loop. In the early 1950's, Joshua Lederberg had discovered that bacteria can exchange genetic information. He found that a frequently-exchanged gene, the F-factor (which conferred fertility), was not linked to other bacterial genes; and he deduced that the DNA of the F-factor was not physically a part of the main bacterial chromosome. In 1952, Lederberg coined the word “plasmid” to denote any extrachromosomal genetic system. In 1959, it was discovered in Japan that genes for resistance to antibiotics can be exchanged between bacteria; and the name “R-factors” was given to these genes. Like the F-factors, the R-factors did not seem to be part of the main loop of bacterial DNA.

Because of the medical implications of this discovery, much attention was focused on the R-factors. It was found that they are plasmids, small loops of DNA existing inside the bacterial cell but not attached to the bacterial chromosome. Further study showed that, in general, between one percent and three percent of bacterial genetic information is carried by plasmids, which can be exchanged freely even between different species of bacteria.

In the words of the microbiologist, Richard Novick, “Appreciation of the role of plasmids has produced a rather dramatic shift in biologists’ thinking about genetics. The traditional view was that the genetic makeup of a species was about the same from one cell to another, and was constant over long periods of time. Now a significant proportion of genetic traits are known to be variable (present in some individual cells or strains, absent in others), labile (subject to frequent loss or gain) and mobile - all because those traits are associated with plasmids or other atypical genetic systems.”

In 1973, Herbert Boyer, Stanley Cohen and their co-workers at Stanford University and the University of California carried out experiments in which they inserted foreign DNA segments, cut with Eco RI, into plasmids (also cut with Eco RI). They then resealed the plasmid loops with DNA ligase. Finally, bacteria were infected with the gene-spliced plasmids. The result was a new strain of bacteria, capable of producing an additional protein coded by the foreign DNA segment which had been spliced into the plasmids.

Cohen and Boyer used plasmids containing a gene for resistance to an antibiotic, so that a few gene-spliced bacteria could be selected from a large population by treating the culture with the antibiotic. The selected bacteria, containing both the antibiotic-resistance marker and the foreign DNA, could then be cloned on a large scale; and in this way a foreign gene could be “cloned”. The gene-spliced bacteria were chimeras, containing genes from two different species.

The new recombinant DNA techniques of Berg, Cohen and Boyer had revolutionary implications: It became possible to produce many copies of a given DNA segment, so that its base sequence could be determined. With the help of direct DNA-sequencing methods developed by Frederick Sanger and Walter Gilbert, the new cloning techniques could be used for mapping and sequencing genes.

Since new bacterial strains could be created, containing genes from other species, it became possible to produce any protein by cloning the corresponding gene. Proteins of medical importance could be produced on a large scale. Thus, the way was open for the production of human insulin, interferon, serum albumin, clotting factors, vaccines, and protein hormones such as ACTH, human growth factor and leuteinizing hormone.

It also became possible to produce enzymes of industrial and agricultural importance by cloning gene-spliced bacteria. Since enzymes catalyze reactions involving smaller molecules, the production of these substrate molecules through gene-splicing also became possible.

It was soon discovered that the possibility of producing new, transgenic organisms was not limited to bacteria. Gene-splicing was also carried out on higher plants and animals as well as on fungi. It was found that the bacterium *Agrobacterium tumefaciens* contains a tumor-inducing (Ti) plasmid capable of entering plant cells and producing a crown gall. Genes spliced into the Ti plasmid quite frequently became incorporated in the plant chromosome, and afterwards were inherited in a stable, Mendelian fashion.

Transgenic animals were produced by introducing foreign DNA into embryo-derived stem cells (ES cells). The gene-spliced ES cells were then selected, cultured and introduced into a blastocyst, which afterwards was implanted in a foster-mother. The resulting chimeric animals were bred, and stable transgenic lines selected.

Thus, for the first time, humans had achieved direct control over the process of evolution. Selective breeding to produce new plant and animal varieties was not new - it is one of the oldest techniques of civilization. However, the degree, precision, and speed of intervention which recombinant DNA made possible was entirely new. In the 1970's it became possible to mix the genetic repertoires of different species: The genes of mice and men could be spliced together into new, man-made forms of life!

The Polymerase Chain Reaction

One day in the early 1980's, an American molecular biologist, Kary Mullis, was driving to his mountain cabin with his girl friend. The journey was a long one, and to pass the time, Kary Mullis turned over and over in his mind a problem which had been bothering him: He worked for a California biotechnology firm, and like many other molecular biologists he had been struggling to analyze very small quantities of DNA. Mullis realized that it would be

desirable have a highly sensitive way of replicating a given DNA segment - a method much more sensitive than cloning. As he drove through the California mountains, he considered many ways of doing this, rejecting one method after the other as impracticable. Finally a solution came to him; and it seemed so simple that he could hardly believe that he was the first to think of it. He was so excited that he immediately pulled over to the side of the road and woke his sleeping girlfriend to tell her about his idea. Although his girlfriend was not entirely enthusiastic about being wakened from a comfortable sleep to be presented with a lecture on biochemistry, Kary Mullis had in fact invented a technique which was destined to revolutionize DNA technology: the Polymerase Chain Reaction (PCR)³.

The technique was as follows: Begin with a small sample of the genomic DNA to be analyzed. (The sample may be extremely small - only a few molecules.) Heat the sample to 95 °C to separate the double-stranded DNA molecule into single strands. Suppose that on the long DNA molecule there is a target segment which one wishes to amplify. If the target segment begins with a known sequence of bases on one strand, and ends with a known sequence on the complementary strand, then synthetic “primer” oligonucleotides⁴ with these known beginning ending sequences are added in excess. The temperature is then lowered to 50-60 °C, and at the lowered temperature, the “start” primer attaches itself to one DNA strand at the beginning of the target segment, while the “stop” primer becomes attached to the complementary strand at the other end of the target segment. Polymerase (an enzyme which aids the formation of double-stranded DNA) is then added, together with a supply of nucleotides. On each of the original pieces of single-stranded DNA, a new complementary strand is generated with the help of the polymerase. Then the temperature is again raised to 95 °C, so that the double-stranded DNA separates into single strands, and the cycle is repeated.

In the early versions of the PCR technique, the polymerase was destroyed by the high temperature, and new polymerase had to be added for each cycle. However, it was discovered that polymerase from the bacterium *Thermus aquaticus* would withstand the high temperature. (*Thermus aquaticus* lives in hot springs.) This discovery greatly simplified the PCR technique. The temperature could merely be cycled between the high and low temperatures, and with each cycle, the population of the target segment doubled, concentrations of primers, deoxynucleotides and polymerase being continuously present.

After a few cycles of the PCR reaction, copies of copies begin to predominate over copies of the original genomic DNA. These copies of copies have a standard length, always beginning on one strand with the start primer, and ending on that strand with the complement of the stop primer.

Two main variants of the PCR technique are possible, depending on the length of the oligonucleotide primers: If, for example, trinucleotides are used as start and stop primers, they can be expected to match the genomic DNA at many points. In that case, after a number of PCR cycles, populations of many different segments will develop. Within each

³ The flash of insight didn't take long, but at least six months of hard work were needed before Mullis and his colleagues could convert the idea to reality.

⁴ Short segments of single-stranded DNA.

population, however, the length of the replicated segment will be standardized because of the predominance of copies of copies. When the resulting solution is placed on a damp piece of paper or a gel and subjected to the effects of an electric current (electrophoresis), the populations of different molecular weights become separated, each population appearing as a band. The bands are profiles of the original genomic DNA; and this variant of the PCR technique can be used in evolutionary studies to determine the degree of similarity of the genomic DNA of two species.

On the other hand, if the oligonucleotide primers contain as many as 20 nucleotides, they will be highly specific and will bind only to a particular target sequence of the genomic DNA. The result of the PCR reaction will then be a single population, containing only the chosen target segment. The PCR reaction can be thought of as autocatalytic, and as we shall see in the next section, autocatalytic systems play an important role in modern theories of the origin of life.

Theories of chemical evolution towards the origin of life

The possibility of an era of chemical evolution prior to the origin of life entered the thoughts of Charles Darwin, but he considered the idea to be much too speculative to be included in his published papers and books. However, in February 1871, he wrote a letter to his close friend Sir Joseph Hooker containing the following words:

“It is often said that all the conditions for the first production of a living organism are now present, which could ever have been present. But if (and oh what a big if) we could conceive in some warm little pond with all sorts of ammonia and phosphoric salts, - light, heat, electricity etc. present, that a protein compound was chemically formed, ready to undergo still more complex changes, at the present day such matter would be instantly devoured, or absorbed, which would not have been the case before living creatures were formed.”

The last letter which Darwin is known to have dictated and signed before his death in 1882 also shows that he was thinking about this problem: “You have expressed quite correctly my views”, Darwin wrote, “where you said that I had intentionally left the question of the Origin of Life uncanvassed as being altogether ultra vires in the present state of our knowledge, and that I dealt only with the manner of succession. I have met with no evidence that seems in the least trustworthy, in favor of so-called Spontaneous Generation. (However) I believe that I have somewhere said (but cannot find the passage) that the principle of continuity renders it probable that the principle of life will hereafter be shown to be a part, or consequence, of some general law..”

Modern researchers, picking up the problem where Darwin left it, have begun to throw a little light on the problem of chemical evolution towards the origin of life. In the 1930's J.B.S. Haldane in England and A.I. Oparin in Russia put forward theories of an era of chemical evolution prior to the appearance of living organisms.

In 1924 Oparin published a pamphlet on the origin of life. An expanded version of this pamphlet was translated into English and appeared in 1936 as a book entitled *The Origin of Life on Earth*. In this book Oparin pointed out that the time when life originated,

conditions on earth were probably considerably different than they are at present: The atmosphere probably contained very little free oxygen, since free oxygen is produced by photosynthesis which did not yet exist. On the other hand, he argued, there were probably large amounts of methane and ammonia in the earth's primitive atmosphere⁵. Thus, before the origin of life, the earth probably had a reducing atmosphere rather than an oxidizing one. Oparin believed that energy-rich molecules could have been formed very slowly by the action of light from the sun. On the present-day earth, bacteria quickly consume energy-rich molecules, but before the origin of life, such molecules could have accumulated, since there were no living organisms to consume them. (This observation is similar to the remark made by Darwin in his 1871 letter to Hooker.)

The first experimental work in this field took place in 1950 in the laboratory of Melvin Calvin at the University of California, Berkeley. Calvin and his co-workers wished to determine experimentally whether the primitive atmosphere of the earth could have been converted into some of the molecules which are the building-blocks of living organisms. The energy needed to perform these conversions they imagined to be supplied by volcanism, radioactive decay, ultraviolet radiation, meteoric impacts, or by lightning strokes.

The earth is thought to be approximately 4.6 billion years old. At the time when Calvin and his co-workers were performing their experiments, the earth's primitive atmosphere was believed to have consisted primarily of hydrogen, water, ammonia, methane, and carbon monoxide, with a little carbon dioxide. A large quantity of hydrogen was believed to have been initially present in the primitive atmosphere, but it was thought to have been lost gradually over a period of time because the earth's gravitational attraction is too weak to effectively hold such a light and rapidly-moving molecule. However, Calvin and his group assumed sufficient hydrogen to be present to act as a reducing agent. In their 1950 experiments they subjected a mixture of hydrogen and carbon dioxide, with a catalytic amount of Fe^{2+} , to bombardment by fast particles from the Berkeley cyclotron. Their experiments resulted in a good yield of formic acid and a moderate yield of formaldehyde. (The fast particles from the cyclotron were designed to simulate an energy input from radioactive decay on the primitive earth.)

Two years later, Stanley Miller, working in the laboratory of Harold Urey at the University of Chicago, performed a much more refined experiment of the same type. In Miller's experiment, a mixture of the gases methane, ammonia, water and hydrogen was subjected to an energy input from an electric spark. Miller's apparatus was designed so that the gases were continuously circulated, passing first through the spark chamber, then through a water trap which removed the non-volatile water soluble products, and then back again through the spark chamber, and so on. The resulting products are shown as a function of time in Figure 3.5.

The Miller-Urey experiment produced many of the building-blocks of living organisms, including glycine, glycolic acid, sarcosine, alanine, lactic acid, N-methylalanine, β -alanine, succinic acid, aspartic acid, glutamic acid, iminodiacetic acid, iminoacetic-propionic acid,

⁵ It is now believed that the main constituents of the primordial atmosphere were carbon dioxide, water, nitrogen, and a little methane.

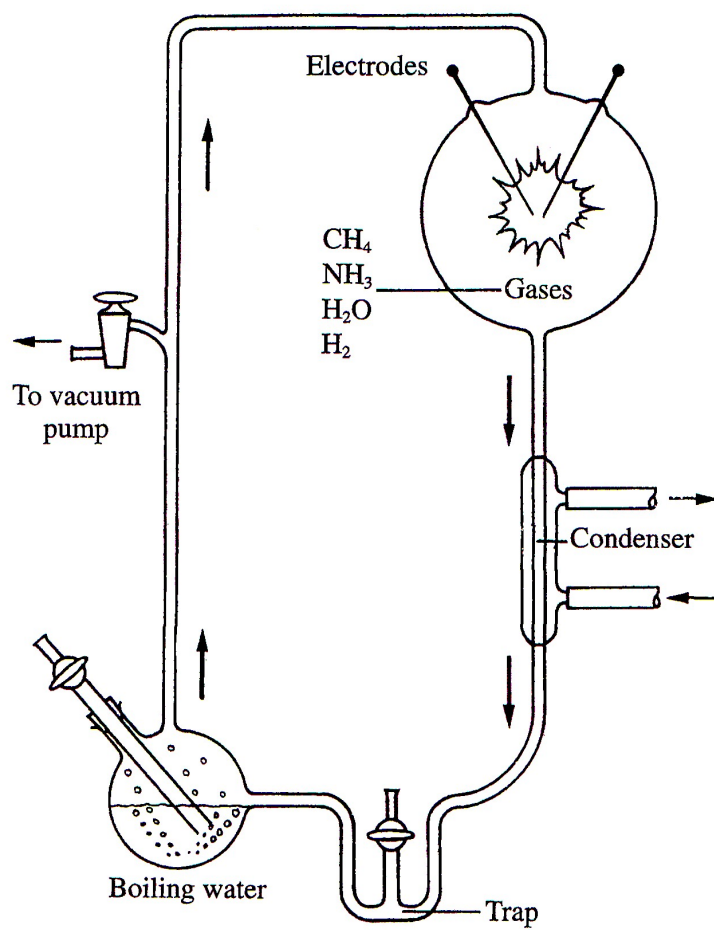

Figure 2.17: Miller's apparatus.

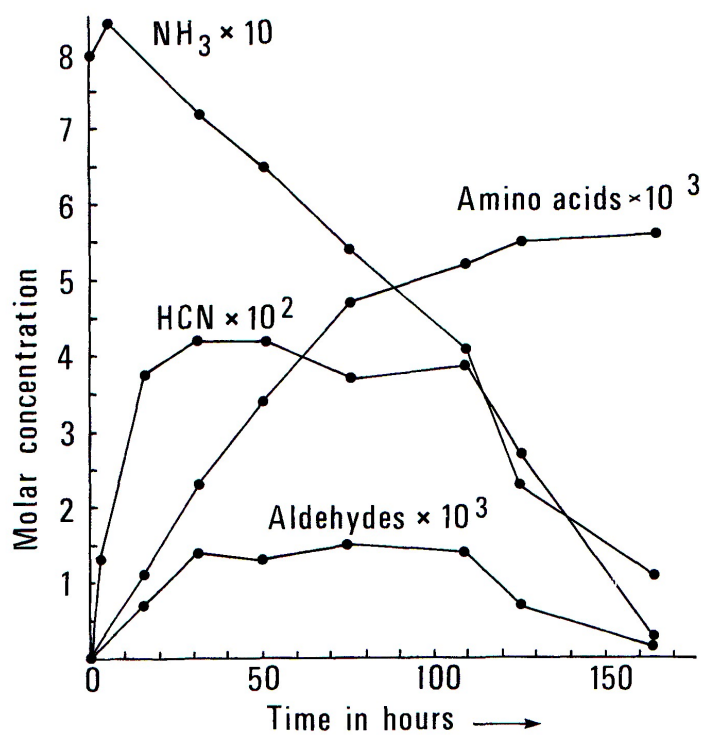

Figure 2.18: Products as a function of time in the Miller-Urey experiment.

formic acid, acetic acid, propionic acid, urea and N-methyl urea⁶. Another major product was hydrogen cyanide, whose importance as an energy source in chemical evolution was later emphasized by Calvin.

The Miller-Urey experiment was repeated and extended by the Ceylonese-American biochemist Cyril Ponnamperuma and by the American expert in planetary atmospheres, Carl Sagan. They showed that when phosphorus is made available, then in addition to amino acids, the Miller-Urey experiment produces not only nucleic acids of the type that join together to form DNA, but also the energy-rich molecule ATP (adenosine triphosphate). ATP is extremely important in biochemistry, since it is a universal fuel which drives chemical reactions inside present-day living organisms.

Further variations on the Miller-Urey experiment were performed by Sydney Fox and his co-workers at the University of Miami. Fox and his group showed that amino acids can be synthesized from a primitive atmosphere by means of a thermal energy input, and that in the presence of phosphate esters, the amino acids can be thermally joined together to form polypeptides. However, some of the peptides produced in this way were cross linked, and hence not of biological interest.

In 1969, Melvin Calvin published an important book entitled *Chemical Evolution; Molecular Evolution Towards the Origin of Living Systems on Earth and Elsewhere*. In this book, Calvin reviewed the work of geochemists showing the presence in extremely ancient rock formations of molecules which we usually think of as being produced only by living organisms. He then discussed experiments of the Miller-Urey type - experiments simulating the first step in chemical evolution. According to Calvin, not only amino acids but also the bases adenine, thymine, guanine, cytosine and uracil, as well as various sugars, were probably present in the primitive ocean in moderate concentrations, produced from the primitive atmosphere by the available energy inputs, and not broken down because no organisms were present.

The next steps visualized by Calvin were dehydration reactions in which the building blocks were linked together into peptides, polynucleotides, lipids and porphyrins. Such dehydration reactions are in a thermodynamically uphill direction. In modern organisms, they are driven by a universally-used energy source, the high-energy phosphate bond of adenosine triphosphate (ATP). Searching for a substance present in the primitive ocean which could have driven the dehydrations, Calvin and his coworkers experimented with hydrogen cyanide (HC=N), and from the results of these experiments they concluded that the energy stored in the carbon-nitrogen triple bond of HC=N could indeed have driven the dehydration reactions necessary for polymerization of the fundamental building blocks. However, later work made it seem improbable that peptides could be produced from cyanide mixtures.

In *Chemical Evolution*, Calvin introduced the concept of autocatalysis as a mechanism for molecular selection, closely analogous to natural selection in biological evolution. Calvin proposed that there were a few molecules in the ancient oceans which could catalyze

⁶ The chemical reaction that led to the formation of the amino acids that Miller observed was undoubtedly the Strecker synthesis: $\text{HCN} + \text{NH}_3 + \text{RC=O} + \text{H}_2\text{O} \rightarrow \text{RC}(\text{NH}_2)\text{COOH}$.

the breakdown of the energy-rich molecules present into simpler products. According to Calvin's hypothesis, in a very few of these reactions, the reaction itself produced more of the catalyst. In other words, in certain cases the catalyst not only broke down the energy-rich molecules into simpler products but also catalyzed their own synthesis. These autocatalysts, according to Calvin, were the first systems which might possibly be regarded as living organisms. They not only "ate" the energy-rich molecules but they also reproduced - i.e., they catalyzed the synthesis of molecules identical with themselves.

Autocatalysis leads to a sort of molecular natural selection, in which the precursor molecules and the energy-rich molecules play the role of "food", and the autocatalytic systems compete with each other for the food supply. In Calvin's picture of molecular evolution, the most efficient autocatalytic systems won this competition in a completely Darwinian way. These more efficient autocatalysts reproduced faster and competed more successfully for precursors and for energy-rich molecules. Any random change in the direction of greater efficiency was propagated by natural selection.

What were these early autocatalytic systems, the forerunners of life? Calvin proposed several independent lines of chemical evolution, which later, he argued, joined forces. He visualized the polynucleotides, the polypeptides, and the metallo-porphyrins as originally having independent lines of chemical evolution. Later, he argued, an accidental union of these independent autocatalysts showed itself to be a still more efficient autocatalytic system. He pointed out in his book that "autocatalysis" is perhaps too strong a word. One should perhaps speak instead of "reflexive catalysis", where a molecule does not necessarily catalyze the synthesis of itself, but perhaps only the synthesis of a precursor. Like autocatalysis, reflexive catalysis is capable of exhibiting Darwinian selectivity.

The theoretical biologist, Stuart Kauffman, working at the Santa Fe Institute, has constructed computer models for the way in which the components of complex systems of reflexive catalysts may have been linked together. Kauffman's models exhibit a surprising tendency to produce orderly behavior even when the links are randomly programmed.

In 1967 and 1968, C. Woese, F.H.C. Crick and L.E. Orgel proposed that there may have been a period of chemical evolution involving RNA alone, prior to the era when DNA, RNA and proteins joined together to form complex self-reproducing systems. In the early 1980's, this picture of an "RNA world" was strengthened by the discovery (by Thomas R. Cech and Sydney Altman) of RNA molecules which have catalytic activity.

Today experiments aimed at throwing light on chemical evolution towards the origin of life are being performed in the laboratory of the Nobel Laureate geneticist Jack Szostak at Harvard Medical School. The laboratory is trying to build a synthetic cellular system that undergoes Darwinian evolution.

In connection with autocatalytic systems, it is interesting to think of the polymerase chain reaction, which we discussed above. The target segment of DNA and the polymerase together form an autocatalytic system. The "food" molecules are the individual nucleotides in the solution. In the PCR system, a segment of DNA reproduces itself with an extremely high degree of fidelity. One can perhaps ask whether systems like the PCR system can have been among the forerunners of living organisms. The cyclic changes of temperature needed for the process could have been supplied by the cycling of water through a hydrothermal

system. There is indeed evidence that hot springs and undersea hydrothermal vents may have played an important role in chemical evolution towards the origin of life. We will discuss this evidence in the next section.

Throughout this discussion of theories of chemical evolution, and the experiments which have been done to support these theories, energy has played a central role. None of the transformations discussed above could have taken place without an energy source, or to be more precise, they could not have taken place without a source of free energy.

Molecular evidence establishing family trees in evolution

Starting in the 1970's, the powerful sequencing techniques developed by Sanger and others began to be used to establish evolutionary trees. The evolutionary closeness or distance of two organisms could be estimated from the degree of similarity of the amino acid sequences of their proteins, and also by comparing the base sequences of their DNA and RNA. One of the first studies of this kind was made by R.E. Dickerson and his coworkers, who studied the amino acid sequences in Cytochrome C, a protein of very ancient origin which is involved in the "electron transfer chain" of respiratory metabolism. Some of the results of Dickerson's studies are shown in Figure 3.6.

Comparison of the base sequences of RNA and DNA from various species proved to be even more powerful tool for establishing evolutionary relationships. Figure 3.7 shows the universal phylogenetic tree established in this way by Iwabe, Woese and their coworkers.⁷ In Figure 3.7, all presently living organisms are divided into three main kingdoms, Eukaryotes, Eubacteria, and Archaeobacteria. Carl Woese, who proposed this classification on the basis of comparative sequencing, wished to call the three kingdoms "Eucarya, Bacteria and Archaea". However, the most widely accepted terms are the ones shown in capital letters on the figure. Before the comparative RNA sequencing work, which was performed on the ribosomes of various species, it had not been realized that there are two types of bacteria, so markedly different from each other that they must be classified as belonging to separate kingdoms. One example of the difference between archaeobacteria and eubacteria is that the former have cell membranes which contain ether lipids, while the latter have ester lipids in their cell membranes. Of the three kingdoms, the eubacteria and the archaeobacteria are "prokaryotes", that is to say, they are unicellular organisms having no cell nucleus. Most of the eukaryotes, whose cells contain a nucleus, are also unicellular, the exceptions being plants, fungi and animals.

One of the most interesting features of the phylogenetic tree shown in Figure 3.7 is that the deepest branches - the organisms with shortest pedigrees - are all hyperthermophiles, i.e. they live in extremely hot environments such as hot springs or undersea hydrothermal vents. The shortest branches represent the most extreme hyperthermophiles. The group

⁷ "Phylogeny" means "the evolutionary development of a species". "Ontogeny" means "the growth and development an individual, through various stages, for example, from fertilized egg to embryo, and so on." Ernst Haeckel, a 19th century follower of Darwin, observed that, in many cases, "ontogeny recapitulates phylogeny."

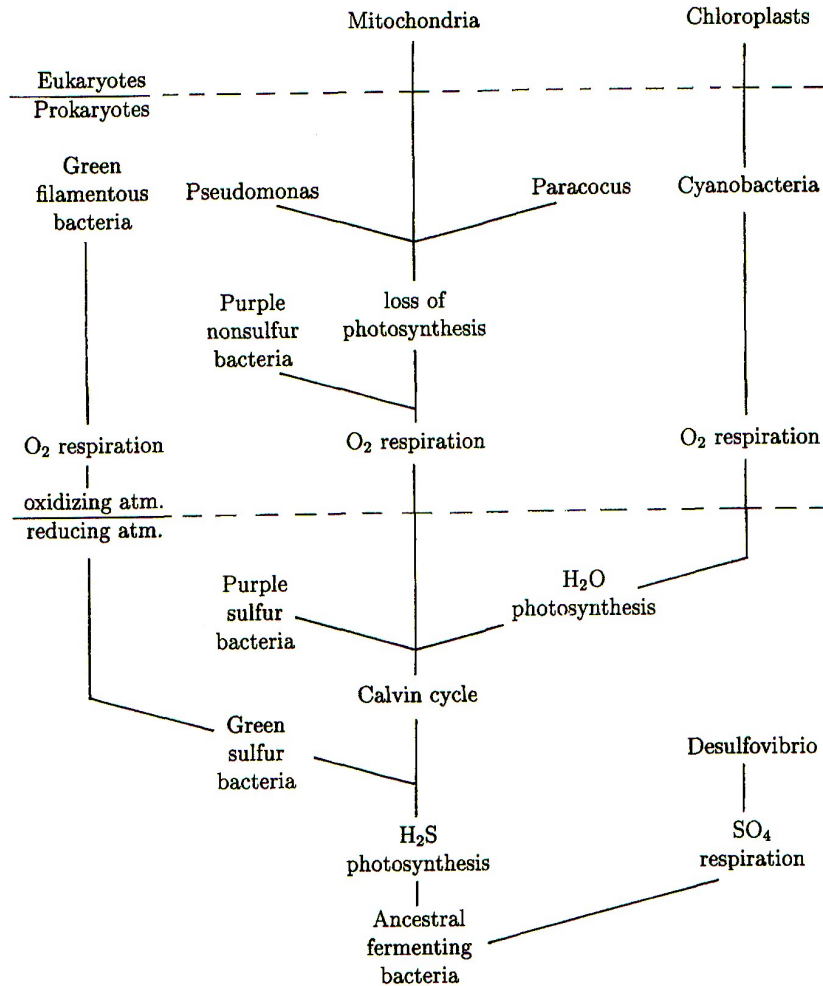

Figure 2.19: Evolutionary relationships established by Dickerson and coworkers by comparing the amino acid sequences of Cytochrome C from various species.

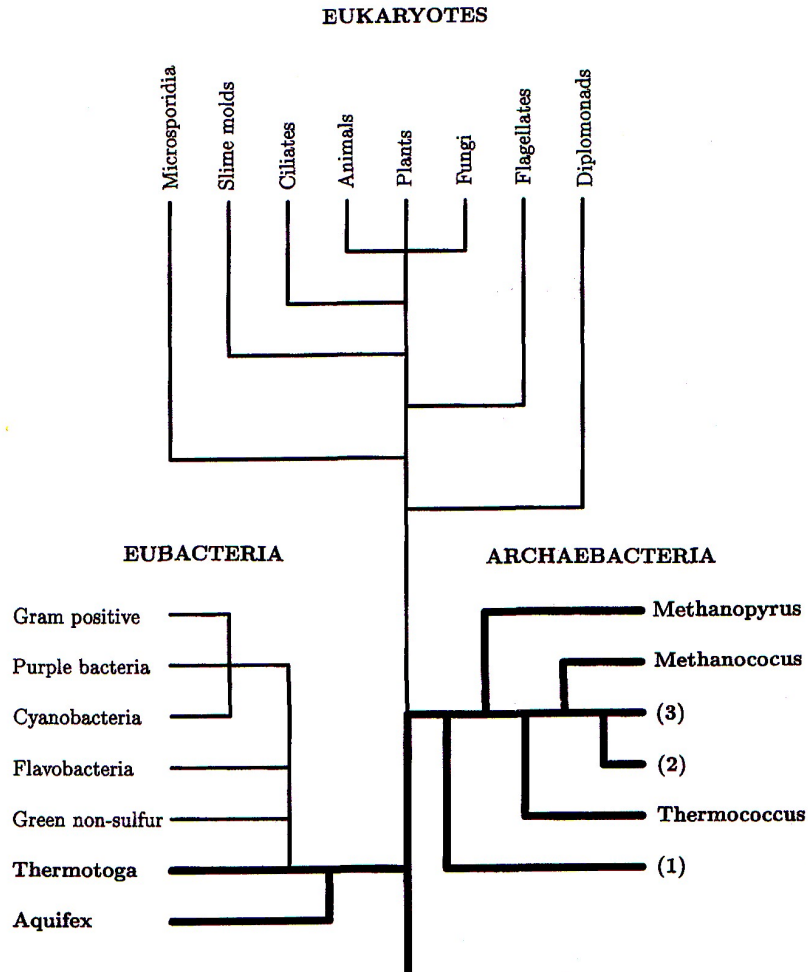

Figure 2.20: This figure shows the universal phylogenetic tree, established by the work of Woese, Iwabe et al. Hyperthermophiles are indicated by bold lines and by bold type.

of archaebacteria indicated by (1) in the figure includes *Thermofilum*, *Thermoproteus*, *Pyrobaculum*, *Pyrodictium*, *Desulfurococcus*, and *Sulfolobus* - all hypothermophiles⁸. Among the eubacteria, the two shortest branches, Aquifex and Thermatoga are both hyperthermophiles⁹

The phylogenetic evidence for the existence of hyperthermophiles at a very early stage of evolution lends support to a proposal put forward in 1988 by the German biochemist Günter Wächterhäuser. He proposed that the reaction for pyrite formation,



which takes place spontaneously at high temperatures, supplied the energy needed to drive the first stages of chemical evolution towards the origin of life. Wächterhäuser pointed out that the surface of the mineral pyrite (FeS₂) is positively charged, and he proposed that, since the immediate products of carbon-dioxide fixation are negatively charged, they would be attracted to the pyrite surface. Thus, in Wächterhäuser's model, pyrite formation not only supplied the reducing agent needed for carbon-dioxide fixation, but also the pyrite surface aided the process. Wächterhäuser further proposed an archaic autocatalytic carbon-dioxide fixation cycle, which he visualized as resembling the reductive citric acid cycle found in present-day organisms, but with all reducing agents replaced by FeS + H₂S, with thioester activation replaced by thioacid activation, and carbonyl groups replaced by thioenol groups. The interested reader can find the details of Wächterhäuser's proposals in his papers, which are listed at the end of this chapter.

A similar picture of the origin of life has been proposed by Michael J. Russell and Alan J. Hall in 1997. In this picture "...(i) life emerged as hot, reduced, alkaline, sulphide-bearing submarine seepage waters interfaced with colder, more oxidized, more acid, Fe²⁺ >>Fe³⁺-bearing water at deep (ca. 4km) floors of the Hadian ocean ca. 4 Gyr ago; (ii) the difference in acidity, temperature and redox potential provided a gradient of pH (ca. 4 units), temperature (ca. 60°C) and redox potential (ca. 500 mV) at the interface of those waters that was sustainable over geological time-scales, providing the continuity of conditions conducive to organic chemical reactions needed for the origin of life..."¹⁰. Russell, Hall and their coworkers also emphasize the role that may have been played by spontaneously-formed 3-dimensional mineral chambers (bubbles). They visualize these as having prevented the reacting molecules from diffusing away, thus maintaining high concentrations.

Table 3.2 shows the energy-yielding reactions which drive the metabolisms of some organisms which are of very ancient evolutionary origin. All the reactions shown in the table make use of H₂, which could have been supplied by pyrite formation at the time when the

⁸ Group (2) in Figure 3.7 includes *Methanothermus*, which is hyperthermophilic, and *Methanobacterium*, which is not. Group (3) includes *Archaeoglobus*, which is hyperthermophilic, and *Halococcus*, *Halobacterium*, *Methanoplanus*, *Methanospirillum*, and *Methanosarcina*, which are not.

⁹ Thermophiles are a subset of the larger group of extremophiles.

¹⁰See W. Martin and M.J. Russell, *On the origins of cells: a hypothesis for the evolutionary transitions from abiotic geochemistry to chemoautotrophic prokaryotes, and from prokaryotes to nucleated cells*, Philos. Trans. R. Soc. Lond. B Biol. Sci., 358, 59-85, (2003).

Table 2.2: **Energy-yielding reactions of some lithoautotrophic hyperthermophiles.** (After K.O. Setter)

| Energy-yielding reaction | Genera |
|--|---|
| $4\text{H}_2 + \text{CO}_2 \rightarrow \text{CH}_4 + 2\text{H}_2\text{O}$ | Methanopyrus, Methanothermus, Methanococcus |
| $\text{H}_2 + \text{S}^\circ \rightarrow \text{H}_2\text{S}$ | Pyrodictium, Thermoproteus, Pyrobaculum, Acidianus, Stygiolobus |
| $4\text{H}_2 + \text{H}_2\text{SO}_4 \rightarrow \text{H}_2\text{S} + 4\text{H}_2\text{O}$ | Archaeoglobus |

organisms evolved. All these organisms are lithoautotrophic, a word which requires some explanation: A heterotrophic organism is one which lives by ingesting energy-rich organic molecules which are present in its environment. By contrast, an autotrophic organism ingests only inorganic molecules. The lithoautotrophs use energy from these inorganic molecules, while the metabolisms of photoautotrophs are driven by energy from sunlight.

Evidence from layered rock formations called “stromatolites”, produced by colonies of photosynthetic bacteria, show that photoautotrophs (or phototrophs) appeared on earth at least 3.5 billion years ago. The geological record also supplies approximate dates for other events in evolution. For example, the date at which molecular oxygen started to become abundant in the earth’s atmosphere is believed to have been 2.0 billion years ago, with equilibrium finally being established 1.5 billion years in the past. Multi-cellular organisms appeared very late on the evolutionary and geological time-scale - only 600 million years ago. By collecting such evidence, the Belgian cytologist Christian de Duve has constructed the phylogenetic tree shown in Figure 3.8, showing branching as a function of time. One very interesting feature of this tree is the arrow indicating the transfer of “endosymbionts” from the eubacteria to the eukaryotes. In the next section, we will look in more detail at this important event, which took place about 1.8 billion years ago.

Symbiosis

The word “symbiosis” is derived from Greek roots meaning “living together”. It was coined in 1877 by the German botanist Albert Bernard Frank. By that date, it had become clear that lichens are composite organisms involving a fungus and an alga; but there was

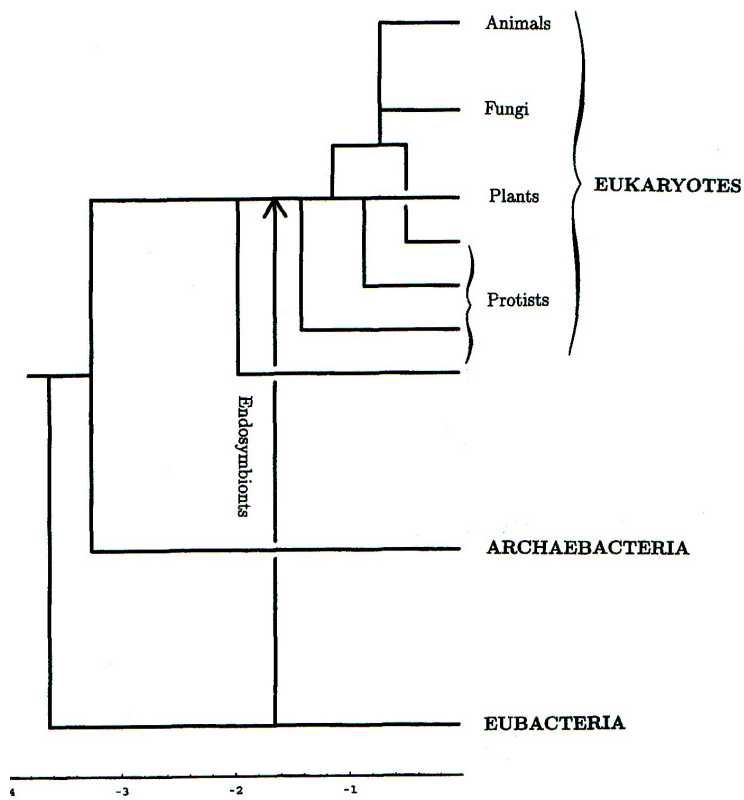

Figure 2.21: Branching of the universal phylogenetic tree as a function of time. “Protists” are unicellular eukaryotes.

controversy concerning whether the relationship was a parasitic one. Was the alga held captive and exploited by the fungus? Or did the alga and the fungus help each other, the former performing photosynthesis, and the latter leeching minerals from the lichen's environment? In introducing the word "symbiosis" (in German, "Symbiotismus"), Frank remarked that "We must bring all the cases where two different species live on or in one another under a comprehensive concept which does not consider the role which the two individuals play but is based on the mere coexistence, and for which the term symbiosis is to be recommended." Thus the concept of symbiosis, as defined by Frank, included all intimate relationships between two or more species, including parasitism at one extreme and "mutualism" at the other. However, as the word is used today, it usually refers to relationships which are mutually beneficial.

Charles Darwin himself had been acutely aware of close and mutually beneficial relationships between organisms of different species. For example, in his work on the fertilization of flowers, he had demonstrated the way in which insects and plants can become exquisitely adapted to each other's needs. However, T.H. Huxley, "Darwin's bulldog", emphasized competition as the predominant force in evolution. "The animal world is on about the same level as a gladiator's show", Huxley wrote in 1888, "The creatures are fairly well treated and set to fight - whereby the strongest, the swiftest and the cunningest live to fight another day. The spectator has no need to turn his thumbs down, as no quarter is given." The view of nature as a sort of "gladiator's contest" dominated the mainstream of evolutionary thought far into the 20th century; but there was also a growing body of opinion which held that symbiosis could be an extremely important mechanism for the generation of new species.

Among the examples of symbiosis studied by Frank were the nitrogen-fixing bacteria living in nodules on the roots of legumes, and the mycorrhizal fungi which live on the roots of forest trees such as oaks, beech and conifers. Frank believed that the mycorrhizal fungi aid in the absorption of nutrients. He distinguished between "ectotrophic" fungi, which form sheaths around the root fibers, and "endotrophic" fungi, which penetrate the root cells. Other examples of symbiosis studied in the 19th century included borderline cases between plants and animals, for example, paramoecia, sponges, hydra, planarian worms and sea anemones, all of which frequently contain green bodies capable of performing photosynthesis.

Writing in 1897, the American lichenologist Albert Schneider prophesied that "future studies may demonstrate that.., plasmic bodies (within the eukaryote cell), such as chlorophyll granules, leucoplastids, chromoplastids, chromosomes, centrosomes, nucleoli, etc., are perhaps symbionts comparable to those in less highly specialized symbiosis. Reinke expresses the opinion that it is not wholly unreasonable to suppose that some highly skilled scientist of the future may succeed in cultivating chlorophyll-bodies in artificial media."

19th century cytologists such as Robert Altman, Andreas Schimper and A. Benda focused attention on the chlorophyll-bodies of plants, which Schimper named chloroplasts, and on another type of subcellular granule, present in large numbers in all plant and animal cells, which Benda named mitochondria, deriving the name from the Greek roots *mitos* (thread) and *chondos* (granule). They observed that these bodies seemed to reproduce

themselves within the cell in very much the manner that might be expected if they were independent organisms. Schimper suggested that chloroplasts are symbionts, and that green plants owe their origin to a union of a colorless unicellular organism with a smaller chlorophyll-containing species.

The role of symbiosis in evolution continued to be debated in the 20th century. Mitochondria were shown to be centers of respiratory metabolism; and it was discovered that both mitochondria and chloroplasts contain their own DNA. However, opponents of their symbiotic origin pointed out that mitochondria alone cannot synthesize all their own proteins: Some mitochondrial proteins require information from nuclear DNA. The debate was finally settled in the 1970's, when comparative sequencing of ribosomal RNA in the laboratories of Carl Woese, W. Ford Doolittle and Michael Gray showed conclusively that both chloroplasts and mitochondria were originally endosymbionts. The ribosomal RNA sequences showed that chloroplasts had their evolutionary root in the cyanobacteria, a species of eubacteria, while mitochondria were traced to a group of eubacteria called the alpha-proteobacteria. Thus the evolutionary arrow leading from the eubacteria to the eukaryotes can today be drawn with confidence, as in Figure 3.8.

Cyanobacteria are bluish photosynthetic bacteria which often become linked to one another so as to form long chains. They can be found today growing in large colonies on seacoasts in many parts of the world, for example in Baja California on the Mexican coast. The top layer of such colonies consists of the phototrophic cyanobacteria, while the organisms in underlying layers are heterotrophs living off the decaying remains of the cyanobacteria. In the course of time, these layered colonies can become fossilized, and they are the source of the layered rock formations called stromatolites (discussed above). Geological dating of ancient stromatolites has shown that cyanobacteria must have originated at least 3.5 billion years ago.

Cyanobacteria contain two photosystems, each making use of a different type of chlorophyll. Photosystem I, which is thought to have evolved first, uses the energy of light to draw electrons from inorganic compounds, and sometimes also from organic compounds (but never from water). Photosystem II, which evolved later, draws electrons from water. Hydrogen derived from the water is used to produce organic compounds from carbon-dioxide, and molecular oxygen is released into the atmosphere. Photosystem II never appears alone. In all organisms which possess it, Photosystem II is coupled to Photosystem I, and together the two systems raise electrons to energy levels that are high enough to drive all the processes of metabolism. Dating of ancient stromatolites makes it probable that cyanobacteria began to release molecular oxygen into the earth's atmosphere at least 3.5 billion years ago; yet from other geological evidence we know that it was only 2 billion years ago that the concentration of molecular oxygen began to rise, equilibrium being reached 1.5 billion years ago. It is believed that ferrous iron, which at one time was very abundant, initially absorbed the photosynthetically produced oxygen. This resulted in the time-lag, as well as the ferrous-ferric mixture of iron which is found in the mineral magnetite.

When the concentrations of molecular oxygen began to rise in earnest, most of the unicellular microorganisms living at the time found themselves in deep trouble, faced with

extinction, because for them oxygen was a deadly poison; and very many species undoubtedly perished. However, some of the archaeobacteria retreated to isolated anaerobic niches where we find them today, while others found ways of detoxifying the poisonous oxygen. Among the eubacteria, the ancestors of the alpha-proteobacteria were particularly good at dealing with oxygen and even turning it to advantage: They developed the biochemical machinery needed for respiratory metabolism.

Meanwhile, during the period between 3.5 and 2.0 billion years before the present, an extremely important evolutionary development had taken place: Branching from the archaeobacteria, a line of large¹¹ heterotrophic unicellular organisms had evolved. They lacked rigid cell walls, and they could surround smaller organisms with their flexible outer membrane, drawing the victims into their interiors to be digested. These new heterotrophs were the ancestors of present-day eukaryotes, and thus they were the ancestors of all multicellular organisms.

Not only are the cells of present-day eukaryotes very much larger than the cells of archaeobacteria and eubacteria; their complexity is also astonishing. Every eukaryote cell contains numerous intricate structures: a nucleus, cytoskeleton, Golgi apparatus, endoplasmic reticulum, mitochondria, peroxisomes, chromosomes, the complex structures needed for mitotic cell division, and so on. Furthermore, the genomes of eukaryotes contain very much more information than those of prokaryotes. How did this huge and relatively sudden increase in complexity and information content take place? According to a growing body of opinion, symbiosis played an important role in this development.

The ancestors of the eukaryotes were in the habit of drawing the smaller prokaryotes into their interiors to be digested. It seems likely that in a few cases the swallowed prokaryotes resisted digestion, multiplied within the host, were transmitted to future generations when the host divided, and conferred an evolutionary advantage, so that the result was a symbiotic relationship. In particular, both mitochondria and chloroplasts have definitely been proved to have originated as endosymbionts. It is easy to understand how the photosynthetic abilities of the chloroplasts (derived from cyanobacteria) could have conferred an advantage to their hosts, and how mitochondria (derived from alpha-proteobacteria) could have helped their hosts to survive the oxygen crisis. The symbiotic origin of other sub-cellular organelles is less well understood and is currently under intense investigation.

If we stretch the definition of symbiosis a little, we can make the concept include cooperative relationships between organisms of the same species. For example, cyanobacteria join together to form long chains, and they live together in large colonies which later turn into stromatolites. Also, some eubacteria have a mechanism for sensing how many of their species are present, so that they know, like a wolf pack, when it is prudent to attack a larger organism. This mechanism, called "quorum sensing", has recently attracted much attention among medical researchers.

The cooperative behavior of a genus of unicellular eukaryotes called slime molds is particularly interesting because it gives us a glimpse of how multicellular organisms may have originated. The name of the slime molds is misleading, since they are not fungi, but

¹¹ not large in an absolute sense, but large in relation to the prokaryotes

heterotrophic protists similar to amoebae. Under ordinary circumstances, the individual cells wander about independently searching for food, which they draw into their interiors and digest, a process called “phagocytosis”. However, when food is scarce, they send out a chemical signal of distress. Researchers have analyzed the molecule which expresses slime mold unhappiness, and they have found it to be cyclic adenosine monophosphate (cAMP). At this signal, the cells congregate and the mass of cells begins to crawl, leaving a slimy trail. As it crawls, the community of cells gradually develops into a tall stalk, surmounted by a sphere - the “fruiting body”. Inside the sphere, spores are produced by a sexual process. If a small animal, for example a mouse, passes by, the spores may adhere to its coat; and in this way they may be transported to another part of the forest where food is more plentiful.

Thus slime molds represent a sort of missing link between unicellular and multicellular organisms. Normally the cells behave as individualists, wandering about independently, but when challenged by a shortage of food, the slime mold cells join together into an entity which closely resembles a multicellular organism. The cells even seem to exhibit altruism, since those forming the stalk have little chance of survival, and yet they are willing to perform their duty, holding up the sphere at the top so that the spores will survive and carry the genes of the community into the future. We should especially notice the fact that the cooperative behavior of the slime mold cells is coordinated by chemical signals.

Sponges are also close to the borderline which separates unicellular eukaryotes (protists) from multicellular organisms, but they are just on the other side of the border. Normally the sponge cells live together in a multicellular community, filtering food from water. However, if a living sponge is forced through a very fine cloth, it is possible to separate the cells from each other. The sponge cells can live independently for some time; but if many of them are left near to one another, they gradually join together and form themselves into a new sponge, guided by chemical signals. In a refinement of this experiment, one can take two living sponges of different species, separate the cells by passing the sponges through a fine cloth, and afterwards mix all the separated cells together. What happens next is amazing: The two types of sponge cells sort themselves out and become organized once more into two sponges - one of each species.

Slime molds and sponges hint at the genesis of multicellular organisms, whose evolution began approximately 600 million years ago. Looking at the slime molds and sponges, we can imagine how it happened. Some unicellular organisms must have experienced an enhanced probability of survival when they lived as colonies. Cooperative behavior and division of labor within the colonies were rewarded by the forces of natural selection, with the selective force acting on the entire colony of cells, rather than on the individual cell. This resulted in the formation of cellular societies and the evolution of mechanisms for cell differentiation. The division of labor within cellular societies (i.e., differentiation) came to be coordinated by chemical signals which affected the transcription of genetic information and the synthesis of proteins. Each cell within a society of cells possessed the entire genome characteristic of the colony, but once a cell had been assigned its specific role in the economy of the society, part of the information became blocked - that is, it was not expressed in the function of that particular cell. As multicellular organisms evolved, the

chemical language of intercellular communication became very much more complex and refined. We will discuss the language of intercellular communication in more detail in a later section.

Geneticists have become increasingly aware that symbiosis has probably played a major role in the evolution of multicellular organisms. We mentioned above that, by means of genetic engineering techniques, transgenic plants and animals can be produced. In these chimeras, genetic material from a foreign species is incorporated into the chromosomes, so that it is inherited in a stable, Mendelian fashion. J.A. Shapiro, one of whose articles is referenced at the end of this chapter, believes that this process also occurs in nature, so that the conventional picture of evolutionary family trees needs to be corrected. Shapiro believes that instead of evolutionary trees, we should perhaps think of webs or networks.

For example, it is tempting to guess that symbiosis may have played a role in the development of the visual system of vertebrates. One of the archaebacteria, the purple halobacterium halobium (recently renamed halobacterium salinarum), is able to perform photosynthesis by means of a protein called bacterial rhodopsin, which transports hydrogen ions across the bacterial membrane. This protein is a near chemical relative of rhodopsin, which combines with a carotinoid to form the “visual purple” used in the vertebrate eye. It is tempting to think that the close similarity of the two molecules is not just a coincidence, and that vertebrate vision originated in a symbiotic relationship between the photosynthetic halobacterium and an aquatic ancestor of the vertebrates, the host being able to sense when the halobacterium was exposed to light and therefore transporting hydrogen ions across its cell membrane.

In this chapter, we have looked at the flow of energy and information in the origin and evolution of life on earth. We have seen how energy-rich molecules were needed to drive the first steps in the origin of life, and how during the evolutionary process, information was preserved, transmitted, and shared between increasingly complex organisms, the whole process being driven by an input of energy. In the next chapter, we will look closely at the relationships between energy and information.

2.4 Life elsewhere in the universe

On December 18, 2017, scientists from the University of California published an article in *Science News* entitled *Ancient fossil microorganisms indicate that life in the universe is common*. According to the article:

“A new analysis of the oldest known fossil microorganisms provides strong evidence to support an increasingly widespread understanding that life in the universe is common.

“The microorganisms, from Western Australia, are 3.465 billion years old. Scientists from UCLA and the University of Wisconsin-Madison report today in the journal *Proceedings of the National Academy of Sciences* that two of the species they studied appear to have performed a primitive form of photosynthesis, another apparently produced methane gas, and two others appear to have consumed methane and used it to build their cell walls.

“The evidence that a diverse group of organisms had already evolved extremely early in

the Earth's history, combined with scientists' knowledge of the vast number of stars in the universe and the growing understanding that planets orbit so many of them, strengthens the case for life existing elsewhere in the universe because it would be extremely unlikely that life formed quickly on Earth but did not arise anywhere else."

Suggestions for further reading

1. H. Lodish, A. Berk, S.L. Zipursky, P. Matsudaira, D. Baltimore, and J. Darnell, *Molecular Cell Biology, 4th Edition*, W.H. Freeman, New York, (2000).
2. Lily Kay, *Who Wrote the Book of Life? A History of the Genetic Code*, Stanford University Press, Stanford CA, (2000).
3. Sahotra Sarkar (editor), *The Philosophy and History of Molecular Biology*, Kluwer Academic Publishers, Boston, (1996).
4. James D. Watson et al. *Molecular Biology of the Gene, 4th Edition*, Benjamin-Cummings, (1988).
5. J.S. Fruton, *Proteins, Enzymes, and Genes*, Yale University Press, New Haven, (1999).
6. S.E. Lauria, *Life, the Unfinished Experiment*, Charles Scribner's Sons, New York (1973).
7. A. Lwoff, *Biological Order*, MIT Press, Cambridge MA, (1962).
8. James D. Watson, *The Double Helix*, Athenium, New York (1968).
9. F. Crick, *The genetic code*, *Scientific American*, 202, 66-74 (1962).
10. F. Crick, *Central dogma of molecular biology*, *Nature*, 227, 561-563 (1970).
11. David Freifelder (editor), *Recombinant DNA, Readings from the Scientific American*, W.H. Freeman and Co. (1978).
12. James D. Watson, John Tooze and David T. Kurtz, *Recombinant DNA, A Short Course*, W.H. Freeman, New York (1983).
13. Richard Hutton, *Biorevolution, DNA and the Ethics of Man-Made Life*, The New American Library, New York (1968).
14. Martin Ebon, *The Cloning of Man*, The New American Library, New York (1978).
15. Sheldon Krinsky, *Genetic Alchemy: The Social History of the Recombinant DNA Controversy*, MIT Press, Cambridge Mass (1983).
16. M. Lappe, *Germs That Won't Die*, Anchor/Doubleday, Garden City N.Y. (1982).
17. M. Lappe, *Broken Code*, Sierra Club Books, San Francisco (1984).
18. President's Commission for the Study of Ethical Problems in Medicine and Biomedical and Behavioral Research, *Splicing Life: The Social and Ethical Issues of Genetic Engineering with Human Beings*, U.S. Government Printing Office, Washington D.C. (1982).
19. U.S. Congress, Office of Technology Assessment, *Impacts of Applied Genetics - Microorganisms, Plants and Animals*, U.S. Government Printing Office, Washington D.C. (1981).
20. W.T. Reich (editor), *Encyclopedia of Bioethics*, The Free Press, New York (1978).

21. Martin Brown (editor), *The Social Responsibility of the Scientist*, The Free Press, New York (1970).
22. B. Zimmerman, *Biofuture*, Plenum Press, New York (1984).
23. John Lear, *Recombinant DNA, The Untold Story*, Crown, New York (1978).
24. B. Alberts, D. Bray, J. Lewis, M. Raff, K. Roberts and J.D. Watson, *Molecular Biology of the Cell*, Garland, New York (1983).
25. C. Woese, *The Genetic Code; The Molecular Basis for Genetic Expression*, Harper and Row, New York, (1967).
26. F.H.C. Crick, *The Origin of the Genetic Code*, J. Mol. Biol. 38, 367-379 (1968).
27. M.W. Niernberg, *The genetic code: II*, Scientific American, 208, 80-94 (1962).
28. L.E. Orgel, *Evolution of the Genetic Apparatus*, J. Mol. Biol. 38, 381-393 (1968).
29. Melvin Calvin, *Chemical Evolution Towards the Origin of Life, on Earth and Elsewhere*, Oxford University Press (1969).
30. R. Shapiro, *Origins: A Skeptic's Guide to the Origin of Life*, Summit Books, New York, (1986).
31. J. William Schopf, *Earth's earliest biosphere: its origin and evolution*, Princeton University Press, Princeton, N.J., (1983).
32. J. William Schopf (editor), *Major Events in the History of Life*, Jones and Bartlet, Boston, (1992).
33. Robert Rosen, *Life itself: a comprehensive inquiry into the nature, origin and fabrication of life*, Colombia University Press, (1991).
34. R.F. Gesteland, T.R. Cech, and J.F. Atkins (editors), *The RNA World, 2nd Edition*, Cold Spring Harbor Laboratory Press, Cold Spring Harbor, New York, (1999).
35. C. de Duve, *Blueprint of a Cell*, Niel Patterson Publishers, Burlington N.C., (1991).
36. C. de Duve, *Vital Dust; Life as a Cosmic Imperative*, Basic Books, New York, (1995).
37. F. Dyson, *Origins of Life*, Cambridge University Press, (1985).
38. S.A. Kaufman, *Antichaos and adaptation*, Scientific American, 265, 78-84, (1991).
39. S.A. Kauffman, *The Origins of Order*, Oxford University Press, (1993).
40. F.J. Varela and J.-P. Dupuy, *Understanding Origins: Contemporary Views on the Origin of Life, Mind and Society*, Kluwer, Dordrecht, (1992).
41. Stefan Bengtson (editor) *Early Life on Earth; Nobel Symposium No. 84*, Colombia University Press, New York, (1994).
42. Herrick Baltscheffsky, *Origin and Evolution of Biological Energy Conversion*, VCH Publishers, New York, (1996).
43. J. Chilea-Flores, T. Owen and F. Raulin (editors), *First Steps in the Origin of Life in the Universe*, Kluwer, Dordrecht, (2001).
44. R.E. Dickerson, *Nature* 283, 210-212 (1980).
45. R.E. Dickerson, *Scientific American* 242, 136-153 (1980).
46. C.R. Woese, *Archaeobacteria*, *Scientific American* 244, 98-122 (1981).
47. N. Iwabe, K. Kuma, M. Hasegawa, S. Osawa and T. Miyata, *Evolutionary relationships of archaeobacteria, eubacteria, and eukaryotes inferred phylogenetic trees of duplicated genes*, *Proc. Nat. Acad. Sci. USA* 86, 9355-9359 (1989).

48. C.R. Woese, O. Kandler, and M.L. Wheelis, *Towards a Natural System of Organisms: Proposal for the Domains Archaea, Bacteria and Eucaria*, Proc. Nat. Acad. Sci. USA *87*, 4576-4579 (1990).
49. W. Ford Doolittle, Phylogenetic Classification and the Universal Tree, *Science*, *284*, (1999).
50. G. Wächterhäuser, *Pyrite formation, the first energy source for life: A hypothesis*, Systematic and Applied Microbiology *10*, 207-210 (1988).
51. G. Wächterhäuser, *Before enzymes and templates: Theory of surface metabolism*, Microbiological Reviews, *52*, 452-484 (1988).
52. G. Wächterhäuser, Evolution of the first metabolic cycles, Proc. Nat. Acad. Sci. USA *87*, 200-204 (1990).
53. G. Wächterhäuser, *Groundworks for an evolutionary biochemistry the iron-sulfur world*, Progress in Biophysics and Molecular Biology **58**, 85-210 (1992).
54. M.J. Russell and A.J. Hall, *The emergence of life from iron monosulphide bubbles at a submarine hydrothermal redox and pH front* J. Geol. Soc. Lond. *154*, 377-402, (1997).
55. L.H. Caporale (editor), *Molecular Strategies in Biological Evolution*, Ann. N.Y. Acad. Sci., May 18, (1999).
56. W. Martin and M.J. Russell, *On the origins of cells: a hypothesis for the evolutionary transitions from abiotic geochemistry to chemoautotrophic prokaryotes, and from prokaryotes to nucleated cells*, Philos. Trans. R. Soc. Lond. B Biol. Sci., *358*, 59-85, (2003).
57. Werner Arber, *Elements in Microbial Evolution*, J. Mol. Evol. *33*, 4 (1991).
58. Michael Gray, *The Bacterial Ancestry of Plastids and Mitochondria*, BioScience, *33*, 693-699 (1983).
59. Michael Grey, *The Endosymbiont Hypothesis Revisited*, International Review of Cytology, *141*, 233-257 (1992).
60. Lynn Margulis and Dorian Sagan, *Microcosmos: Four Billion Years of Evolution from Our Microbial Ancestors*, Allan and Unwin, London, (1987).
61. Lynn Margulis and Rene Fester, eds., *Symbiosis as a Source of Evolutionary Innovation: Speciation and Morphogenesis*, MIT Press, (1991).
62. Charles Mann, *Lynn Margulis: Science's Unruly Earth Mother*, *Science*, *252*, 19 April, (1991).
63. Jan Sapp, *Evolution by Association; A History of Symbiosis*, Oxford University Press, (1994).
64. J.A. Shapiro, *Natural genetic engineering in evolution*, Genetics, *86*, 99-111 (1992).
65. E.M. De Robertis et al., *Homeobox genes and the vertebrate body plan*, Scientific American, July, (1990).
66. J.S. Schrum, T.F. Zhu and J.W. Szostak, *The origins of cellular life*, Cold Spring Harb. Perspect. Biol., May 19 (2010).
67. I. Budin and J.W. Szostak, *Expanding Roles for Diverse Physical Phenomena During the Origin of Life*, Annu. Rev. Biophys., *39*, 245-263, (2010).
68. P.J. Bowler, *Evolution: The History of an Idea*, University of California Press, (1989).

69. D.J. Putuyma, *Evolutionary Biology*, Sinauer Associates, Sunderland Mass., (1986).
70. B. Glass, O. Temkin, and W.L. Strauss, eds., *Forerunners of Darwin: 1745-1859*, Johns Hopkins Press, Baltimore, (1959).
71. R. Milner, *The Encyclopedia of Evolution*, an Owl Book, Henry Holt and Company, New York, (1990).
72. T.A. Appel, *The Cuvier-Geoffroy Debate: French Biology in the Decades before Darwin*, Oxford University Press, (1987).
73. P.J. Bowler, *Fossils and Progress: Paleontology and the Idea of Progressive Evolution in the Nineteenth Century*, Science History Publications, New York, (1976).
74. H. Torrens, *Presidential Address: Mary Anning (1799-1847) of Lyme; 'the greatest fossilist the world ever knew'*, *British Journal of the History of Science*, 28, 257-284, (1995).
75. P. Corsi, *The Age of Lamarck: Evolutionary Theories in France, 1790-1834*, University of California Press, Berkeley, (1988).
76. C.C. Gillispie, *Genesis and Geology: A Study in the Relations of Scientific Thought, Natural Theology and Social Opinion in Great Britain, 1790-1850*, Harvard University Press, Cambridge Mass., (1951).
77. M. McNeil, *Under the Banner of Science: Erasmus Darwin and his Age*, Manchester University Press, Manchester, (1987).
78. L.G. Wilson, *Sir Charles Lyell's Scientific Journals on the Species Question*, Yale University Press, New Haven, (1970).
79. M.J.S. Rudwick, *The Meaning of Fossils: Episodes in the History of Paleontology*, 2nd ed., University of Chicago Press, (1985).
80. A.B. Adams, *Eternal Quest: The Story of the Great Naturalists*, G.P. Putnam's Sons, New York, (1969).
81. A.S. Packard, *Lamarck, the Founder of Evolution: His Life and Work*, Longmans, Green, and Co., New York, (1901).
82. C. Darwin, *An historical sketch of the progress of opinion on the Origin of Species, previously to the publication of this work*, Appended to third and later editions of *On the Origin of Species*, (1861).
83. L. Eiseley, *Darwin's Century: Evolution and the Men who Discovered It*, Doubleday, New York, (1958).
84. H.F. Osborne, *From the Greeks to Darwin: The Development of the Evolution Idea Through Twenty-Four Centuries*, Charles Scribner and Sons, New York, (1929).
85. Sir Julian Huxley and H.B.D. Kettlewell, *Charles Darwin and his World*, Thames and Hudson, London, (1965).
86. Allan Moorehead, *Darwin and the Beagle*, Penguin Books Ltd., (1971).
87. Francis Darwin (editor), *The Autobiography of Charles Darwin and Selected Letters*, Dover, New York, (1958).
88. Charles Darwin, *The Voyage of the Beagle*, J.M. Dent and Sons Ltd., London, (1975).
89. Charles Darwin, *The Origin of Species*, Collier MacMillan, London, (1974).
90. Charles Darwin, *The Expression of Emotions in Man and Animals*, The University of Chicago Press (1965).

91. D.W. Forest, *Francis Galton, The Life and Work of a Victorian Genius*, Paul Elek, London (1974).
92. Ruth Moore, *Evolution*, Time-Life Books (1962).
93. L. Barber, *The Heyday of Natural History: 1820-1870*, Doubleday and Co., Garden City, New York, (1980).
94. A. Desmond, *Huxley*, Addison Wesley, Reading, Mass., (1994).
95. R. Owen, (P.R. Sloan editor), *The Hunterian Lectures in Comparative Anatomy*, May-June, 1837, University of Chicago Press, (1992).
96. C. Nichols, *Darwinism and the social sciences*, Phil. Soc. Scient. 4, 255-277 (1974).
97. M. Ruse, *The Darwinian Revolution*, University of Chicago Press, (1979).
98. A. Desmond and J. Moore, *Darwin*, Penguin Books, (1992).
99. R. Dawkins, *The Extended Phenotype*, Oxford University Press, (1982).
100. R. Dawkins, *The Blind Watchmaker*, W.W. Norton, (1987).
101. R. Dawkins, *River out of Eden: A Darwinian View of Life*, Harper Collins, (1995).
102. R. Dawkins, *Climbing Mount Improbable*, W.W. Norton, (1996).
103. S.J. Gould, *Ever Since Darwin*, W.W. Norton, (1977).
104. S.J. Gould, *The Panda's Thumb*, W.W. Norton, (1980).
105. S.J. Gould, *Hen's Teeth and Horse's Toes*, W.W. Norton, (1983).
106. S.J. Gould, *The Burgess Shale and the Nature of History*, W.W. Norton, (1989).
107. R.G.B. Reid, *Evolutionary Theory: The Unfinished Synthesis*, Croom Helm, (1985).
108. M. Ho and P.T. Saunders, editors, *Beyond Neo-Darwinism: An Introduction to a New Evolutionary Paradigm*, Academic Press, London, (1984).
109. J. Maynard Smith, *Did Darwin Get it Right? Essays on Games, Sex and Evolution*, Chapman and Hall, (1989).
110. E. Sober, *The Nature of Selection: Evolutionary Theory in Philosophical Focus*, University of Chicago Press, (1984).
111. B.K. Hall, *Evolutionary Developmental Biology*, Chapman and Hall, London, (1992).
112. J. Thompson, *Interaction and Coevolution*, Wiley and Sons, (1982).
113. N. Tinbergen, *The Study of Instinct*, Oxford University Press, (1951).
114. N. Tinbergen, *Social Behavior in Animals*, Methuen, London, (1953).
115. N. Tinbergen, *The Animal in its World: Explorations of an Ethologist*, Allan and Unwin, London, (1973).
116. K. Lorenz, *On the evolution of behavior*, Scientific American, December, (1958).
117. K. Lorenz, *Studies in Animal and Human Behavior. I and II.*, Harvard University Press, (1970) and (1971).
118. P.H. Klopfer and J.P. Hailman, *An Introduction to Animal Behavior: Ethology's First Century*, Prentice-Hall, New Jersey, (1969).
119. J. Jaynes, *The historical origins of "Ethology" and "Comparative Psychology"*, Anim. Behav. 17, 601-606 (1969).
120. W.H. Thorpe, *The Origin and Rise of Ethology: The Science of the Natural Behavior of Animals*, Heinemann, London, (1979).
121. R.A. Hinde, *Animal Behavior: A Synthesis of Ethological and Comparative Psychology*, McGraw-Hill, New York, (1970).

122. J.H. Crook, editor, *Social Behavior in Birds and Mammals*, Academic Press, London, (1970).
123. P. Ekman, editor, *Darwin and Facial Expression*, Academic Press, New York, (1973).
124. P. Ekman, W.V. Friesen and P. Ekworth, *Emotions in the Human Face*, Pergamon, New York, (1972).
125. N. Burton Jones, editor, *Ethological Studies of Child Behavior*, Cambridge University Press, (1975).
126. M. von Cranach, editor, *Methods of Inference from Animals to Human Behavior*, Chicago/Mouton, Haag, (1976); Aldine, Paris, (1976).
127. K. Lorenz, *On Aggression*, Bantam Books, (1977).
128. I. Eibl-Eibesfeld, *Ethology, The Biology of Behavior*, Holt, Rinehart and Winston, New York, (1975).
129. P.P.G. Bateson and R.A. Hinde, editors, *Growing Points in Ethology*, Cambridge University Press, (1976).
130. J. Bowlby, *By ethology out of psychoanalysis: An experiment in interbreeding*, *Animal Behavior*, 28, 649-656 (1980).
131. B.B. Beck, *Animal Tool Behavior*, Garland STPM Press, New York, (1980).
132. R. Axelrod, *The Evolution of Cooperation*, Basic Books, New York, (1984).
133. J.D. Carthy and F.L. Ebling, *The Natural History of Aggression*, Academic Press, New York, (1964)
134. D.L. Cheney and R.M. Seyfarth, *How Monkeys See the World: Inside the Mind of Another Species*, University of Chicago Press, (1990).
135. F. De Waal, *Chimpanzee Politics*, Cape, London, (1982).
136. M. Edmunds, *Defense in Animals*, Longman, London, (1974).
137. R.D. Estes, *The Behavior Guide to African Mammals*, University of California Press, Los Angeles, (1991).
138. R.F. Ewer, *Ethology of Mammals*, Logos Press, London, (1968).
139. H. Lodish, A. Berk, S.L. Zipursky, P. Matsudaira, D. Baltimore, and J. Darnell, *Molecular Cell Biology, 4th Edition*, W.H. Freeman, New York, (2000).
140. Lily Kay, *Who Wrote the Book of Life? A History of the Genetic Code*, Stanford University Press, Stanford CA, (2000).
141. Sahotra Sarkar (editor), *The Philosophy and History of Molecular Biology*, Kluwer Academic Publishers, Boston, (1996).
142. James D. Watson et al. *Molecular Biology of the Gene, 4th Edition*, Benjamin-Cummings, (1988).
143. J.S. Fruton, *Proteins, Enzymes, and Genes*, Yale University Press, New Haven, (1999).
144. S.E. Lauria, *Life, the Unfinished Experiment*, Charles Scribner's Sons, New York (1973).
145. A. Lwoff, *Biological Order*, MIT Press, Cambridge MA, (1962).
146. James D. Watson, *The Double Helix*, Athenium, New York (1968).
147. F. Crick, *The genetic code*, *Scientific American*, 202, 66-74 (1962).
148. F. Crick, *Central dogma of molecular biology*, *Nature*, 227, 561-563 (1970).

149. David Freifelder (editor), *Recombinant DNA, Readings from the Scientific American*, W.H. Freeman and Co. (1978).
150. James D. Watson, John Tooze and David T. Kurtz, *Recombinant DNA, A Short Course*, W.H. Freeman, New York (1983).
151. Richard Hutton, *Biorevolution, DNA and the Ethics of Man-Made Life*, The New American Library, New York (1968).
152. Martin Ebon, *The Cloning of Man*, The New American Library, New York (1978).
153. Sheldon Krimsky, *Genetic Alchemy: The Social History of the Recombinant DNA Controversy*, MIT Press, Cambridge Mass (1983).
154. M. Lappe, *Germs That Won't Die*, Anchor/Doubleday, Garden City N.Y. (1982).
155. M. Lappe, **Broken Code**, Sierra Club Books, San Francisco (1984).
156. President's Commission for the Study of Ethical Problems in Medicine and Biomedical and Behavioral Research, *Splicing Life: The Social and Ethical Issues of Genetic Engineering with Human Beings*, U.S. Government Printing Office, Washington D.C. (1982).
157. U.S. Congress, Office of Technology Assessment, *Impacts of Applied Genetics - Microorganisms, Plants and Animals*, U.S. Government Printing Office, Washington D.C. (1981).
158. W.T. Reich (editor), *Encyclopedia of Bioethics*, The Free Press, New York (1978).
159. Martin Brown (editor), *The Social Responsibility of the Scientist*, The Free Press, New York (1970).
160. B. Zimmerman, *Biofuture*, Plenum Press, New York (1984).
161. John Lear, *Recombinant DNA, The Untold Story*, Crown, New York (1978).
162. B. Alberts, D. Bray, J. Lewis, M. Raff, K. Roberts and J.D. Watson, **Molecular Biology of the Cell**, Garland, New York (1983).
163. C. Woese, *The Genetic Code; The Molecular Basis for Genetic Expression*, Harper and Row, New York, (1967).
164. F.H.C. Crick, *The Origin of the Genetic Code*, J. Mol. Biol. 38, 367-379 (1968).
165. M.W. Niernberg, *The genetic code: II*, Scientific American, 208, 80-94 (1962).
166. L.E. Orgel, *Evolution of the Genetic Apparatus*, J. Mol. Biol. 38, 381-393 (1968).
167. Melvin Calvin, *Chemical Evolution Towards the Origin of Life, on Earth and Elsewhere*, Oxford University Press (1969).
168. R. Shapiro, *Origins: A Skeptic's Guide to the Origin of Life*, Summit Books, New York, (1986).
169. J. William Schopf, *Earth's earliest biosphere: its origin and evolution*, Princeton University Press, Princeton, N.J., (1983).
170. J. William Schopf (editor), *Major Events in the History of Life*, Jones and Bartlet, Boston, (1992).
171. Robert Rosen, *Life itself: a comprehensive inquiry into the nature, origin and fabrication of life*, Columbia University Press, (1991).
172. R.F. Gesteland, T.R. Cech, and J.F. Atkins (editors), *The RNA World, 2nd Edition*, Cold Spring Harbor Laboratory Press, Cold Spring Harbor, New York, (1999).
173. C. de Duve, *Blueprint of a Cell*, Niel Patterson Publishers, Burlington N.C., (1991).

174. C. de Duve, *Vital Dust; Life as a Cosmic Imperative*, Basic Books, New York, (1995).
175. F. Dyson, *Origins of Life*, Cambridge University Press, (1985).
176. S.A. Kaufman, *Antichaos and adaption*, Scientific American, *265*, 78-84, (1991).
177. S.A. Kauffman, *The Origins of Order*, Oxford University Press, (1993).
178. F.J. Varela and J.-P. Dupuy, *Understanding Origins: Contemporary Views on the Origin of Life, Mind and Society*, Kluwer, Dordrecht, (1992).
179. Stefan Bengtson (editor) *Early Life on Earth; Nobel Symposium No. 84*, Columbia University Press, New York, (1994).
180. Herrick Baltcheffsky, *Origin and Evolution of Biological Energy Conversion*, VCH Publishers, New York, (1996).
181. J. Chilea-Flores, T. Owen and F. Raulin (editors), *First Steps in the Origin of Life in the Universe*, Kluwer, Dordrecht, (2001).
182. R.E. Dickerson, *Nature* *283*, 210-212 (1980).
183. R.E. Dickerson, *Scientific American* *242*, 136-153 (1980).
184. C.R. Woese, *Archaeobacteria*, *Scientific American* *244*, 98-122 (1981).
185. N. Iwabe, K. Kuma, M. Hasegawa, S. Osawa and T. Miyata, *Evolutionary relationships of archaeobacteria, eubacteria, and eukaryotes inferred phylogenetic trees of duplicated genes*, *Proc. Nat. Acad. Sci. USA* *86*, 9355-9359 (1989).
186. C.R. Woese, O. Kundler, and M.L. Wheelis, *Towards a Natural System of Organisms: Proposal for the Domains Archaea, Bacteria and Eucaria*, *Proc. Nat. Acad. Sci. USA* *87*, 4576-4579 (1990).
187. W. Ford Doolittle, *Phylogenetic Classification and the Universal Tree*, *Science*, *284*, (1999).
188. G. Wächterhäuser, *Pyrite formation, the first energy source for life: A hypothesis*, *Systematic and Applied Microbiology* *10*, 207-210 (1988).
189. G. Wächterhäuser, *Before enzymes and templates: Theory of surface metabolism*, *Microbiological Reviews*, *52*, 452-484 (1988).
190. G. Wächterhäuser, *Evolution of the first metabolic cycles*, *Proc. Nat. Acad. Sci. USA* *87*, 200-204 (1990).
191. G. Wächterhäuser, *Groundworks for an evolutionary biochemistry the iron-sulfur world*, *Progress in Biophysics and Molecular Biology* **58**, 85-210 (1992).
192. M.J. Russell and A.J. Hall, *The emergence of life from iron monosulphide bubbles at a submarine hydrothermal redox and pH front* *J. Geol. Soc. Lond.* *154*, 377-402, (1997).
193. L.H. Caporale (editor), *Molecular Strategies in Biological Evolution*, *Ann. N.Y. Acad. Sci.*, *May 18*, (1999).
194. W. Martin and M.J. Russell, *On the origins of cells: a hypothesis for the evolutionary transitions from abiotic geochemistry to chemoautotrophic prokaryotes, and from prokaryotes to nucleated cells*, *Philos. Trans. R. Soc. Lond. B Biol. Sci.*, *358*, 59-85, (2003).
195. Werner Arber, *Elements in Microbial Evolution*, *J. Mol. Evol.* *33*, 4 (1991).
196. Michael Gray, *The Bacterial Ancestry of Plastids and Mitochondria*, *BioScience*, *33*, 693-699 (1983).

197. Michael Grey, *The Endosymbiont Hypothesis Revisited*, International Review of Cytology, *141*, 233-257 (1992).
198. Lynn Margulis and Dorian Sagan, *Microcosmos: Four Billion Years of Evolution from Our Microbial Ancestors*, Allan and Unwin, London, (1987).
199. Lynn Margulis and Rene Fester, eds., *Symbiosis as a Source of Evolutionary Innovation: Speciation and Morphogenesis*, MIT Press, (1991).
200. Charles Mann, *Lynn Margulis: Science's Unruly Earth Mother*, Science, *252*, 19 April, (1991).
201. Jan Sapp, *Evolution by Association; A History of Symbiosis*, Oxford University Press, (1994).
202. J.A. Shapiro, *Natural genetic engineering in evolution*, Genetics, *86*, 99-111 (1992).
203. E.M. De Robertis et al., *Homeobox genes and the vertebrate body plan*, Scientific American, *July*, (1990).
204. J.S. Schrum, T.F. Zhu and J.W. Szostak, *The origins of cellular life*, Cold Spring Harb. Perspect. Biol., *May 19* (2010).
205. I. Budin and J.W. Szostak, *Expanding Roles for Diverse Physical Phenomena During the Origin of Life*, Annu. Rev. Biophys., *39*, 245-263, (2010).
206. M. Eigen et al., *The Origin of genetic information*, Scientific American, April, 78-94 (1981).
207. L.E. Kay, *Cybernetics, information, life: The emergence of scriptural representations of heredity*, Configurations, *5*, 23-91 (1997).
208. T.D. Schneider, G.D. Stormo, L. Gold and A. Ehrenfeucht, *Information content of binding sites on nucleotide sequences*, J. Mol. Biol. **88**, 415-431 (1986).
209. J. Avery, *A model for biological specificity*, Int. J. Quant. Chem., *26*, 843 (1984).
210. P.G. Mezey, *Shape in Chemistry: An Introduction to Molecular Shape and Topology*, VCH Publishers, New York, (1993).
211. P.G. Mezey, *Potential Energy Hypersurfaces*, Elsevier, Amsterdam, (1987).
212. P.G. Mezey, *Molecular Informatics and Topology in Chemistry*, in *Topology in Chemistry*, R.B. King and D.H. Rouvray, eds., Ellis Horwood, Pbl., U.K., (2002).
213. G. Stent, *Cellular communication*, Scientific American, *227*, 43-51 (1972).
214. A. Macieira-Coelho, editor, *Signaling Through the Cell Matrix*, Progress in Molecular and Subcellular Biology, *25*, Springer, (2000).
215. D.H. Hubel, *The visual cortex of the brain*, Scientific American, *209*, *54*, November, (1963).
216. J.Z. Young, *Programs of the Brain*, Oxford University Press, (1978).
217. J.Z. Young, *Philosophy and the Brain*, Oxford University Press, (1987).
218. K. von Frisch, *Dialects in the languages of bees*, Scientific American, **August**, (1962).
219. R.A. Hinde, *Non-Verbal Communication*, Cambridge University Press, (1972).
220. E.O. Wilson, *Animal communication*, Scientific American, *227*, 52-60 (1972).
221. E.O. Wilson, *Sociobiology*, Harvard University Press, (1975).
222. H.S. Terrace, L.A. Petitto, et al., *Can an ape create a sentence?*, Science, *206*, 891-902 (1979).

223. S. Savage-Rumbaugh, R. Lewin, et al., Kanzi: *The Ape at the Brink of the Human Mind*, John Wiley and Sons, New York, (1996).
224. R.W. Rutledge, B.L. Basore, and R.J. Mulholland, *Ecological stability: An information theory viewpoint*, J. Theor. Biol., *57*, 355-371 (1976).
225. L. Johnson, *Thermodynamics and ecosystems*, in *The Handbook of Environmental Chemistry*, O. Hutzinger, editor, Springer Verlag, Heidelberg, (1990), pp. 2-46.
226. C. Pahl-Wostl, *Information theoretical analysis of functional temporal and spatial organization in flow networks*, Math. Comp. Model. *16 (3)*, 35-52 (1992).
227. C. Pahl-Wostl, *The Dynamic Nature of Ecosystems: Chaos and Order Intertwined*, Wiley, New York, (1995).
228. E.D. Schneider and J.J. Kay, *Complexity and thermodynamics: Towards a new ecology*, Futures, *24 (6)*, 626-647 (1994).
229. R.E. Ulanowicz, **Ecology, the Ascendent Perspective**, Columbia University Press, New York, (1997).
230. H. Lodish, A. Berk, S.L. Zipursky, P. Matsudaira, D. Baltimore, and J. Darnell, *Molecular Cell Biology, 4th Edition*, W.H. Freeman, New York, (2000).

Chapter 3

OUR ANCESTORS

3.1 Timeline for the evolution of life on the Earth

The dates shown here are taken from the Wikipedia article entitled *Timeline of the evolutionary history of life*. The unit BYA means “Billion years ago”, while MYA means “Million years ago”.

- 4.540 BYA. Earliest Earth
- 4.404 BYA, First appearance of water on Earth.
- 4.280 BYA. Earliest appearance of life on Earth.¹
- 3.900 BYA, Cells resembling prokaryotes appear. These first organisms use CO₂ as a source of carbon, and obtain energy by oxidizing inorganic materials.
- 3.500 BYA, Lifetime of the last universal common ancestor. The split between bacteria and archae occurs.
- 3.000 BYA, Photosynthetic cyanobacteria evolved. They used water as a reducing agent and produced oxygen as a waste product.
- 2.800 BYA, Earliest evidence of microbial life on land.
- 2.500 BYA, Great Oxygenation Event, produced by cyanobacteria’s oxygenic photosynthesis.
- 1.850 BYA, Eukaryotic cells appear. They probably evolved from cooperative assemblages of prokaryotes (phagocytosis and symbiosis).
- 1.200 BYA, Sexual reproduction first appears in the fossil records. It may have existed earlier.
- 0.800 BYA, First multicellular organisms.
- 0.600 BYA, The ozone layer is formed, making landbased life more possible.
- 0.580-0.500 BYA, The Cambrian Explosion. Biodiversity quickly increases and most modern phyla of animals appear in the fossil record.

¹This date for the first appearance of life on earth is earlier than previously thought possible. It is based on the ratio of carbon isotopes in zircon rocks recently found in Australia.

- 0.560 BYA, Fungi appear.
- 0.550 BYA, Comb jellies, sponges, sea anemones and corals evolved.
- 0.530 BYA, The first known fossilized footprints on land.
- 0.485 BYA, Jawless fishes.
- 0.434 BYA, The first primitive plants move onto land, accompanied by fungi which may have helped them.
- 0.420 BYA, Ray-finned fishes, arachnids, and land scorpions.
- 0.410 BYA, First signs of teeth in fish.
- 0.395 BYA, First lichens, stonewarts, harvestmen and springtails. The first known tracks of four-legged animals on land.
- 0.363 BYA, The Carboniferous Period starts. Insects appear on land and soon learn to fly. Seed-bearing plants and forests cover the land.
- 0.360 BYA, First crabs and ferns. Land flora dominated by ferns.
- 0.350 BYA, Large sharks, ratfishes and hagfish.
- 0.320 BYA, The precursors of mammals separate from the precursors to reptiles.
- 0.280 BYA, Earliest beetles, seed plants and conifers diversify.
- 0.2514 BYA, The Permian-Triassic extinction event eliminates 90-95% of marine species, and 70% of terrestrial vertebrates.²
- 0.245 BYA, Earliest ichthyosaurs (i.e. seagoing dinosaurs).
- 0.225 BYA, Earliest dinosaurs. First mammals.
- 0.220 BYA, Seed-producing forests dominate the land. Herbivours grow to huge sizes. First flies and turtles.
- 0.155 BYA, First bloodsucking insects. Archaeopteryx, a possible ancestor of birds, appears.
- 0.130 BYA, Rise of the flowering plants. Coevolution of plants and their pollinators.
- 0.115 BYA, First monotreme (egg-laying) mammals.
- 0.110 BYA, Toothed diving birds.
- 0.100 BYA, Earliest bees.
- 0.090 BYA, Probable origin of placental mammals. However, the first undisputed fossil evidence is from 0.066 BYA.
- 0.080 BYA, First ants.
- 0.066 BYA, The Cretaceous-Paleogene extinction event wipes out about half of all animal species, including all of the dinosaurs except the birds. Afterwards, mammals become the dominant animal species. Conifers dominate northern forests.
- 0.060 BYA, Earliest true primates. Diversification of large, flightless birds. The ancestors of carnivorous mammals had appeared.
- 0.055 BYA, Diversification of birds. First songbirds, parrots, loons, swifts, and woodpeckers. First whale.

²Today, there is a danger that human use of fossil fuels will initiate a very similar extinction event. This danger will be discussed in a later chapter.

- 0.052 BYA, First bats appear in the fossil record.
- 0.050 BYA, Tapirs, rhinoceroses and camels appear. Diversification of primates.
- 0.040 BYA, Modern-type moths and butterflies were alive.
- 0.035 BYA, Grasses diversify. Many modern mammal groups appear.
- 0.030 BYA, Earliest pigs and cats.
- 0.025 BYA, First deer.
- 0.020 BYA, Giraffes, hyenas, bears, and giant anteaters appear. Birds increase in diversity.
- 0.015 BYA, First mastodons. Australian megafauna diversify. Kangaroos appear.
- 0.010 BYA, Grasslands and savannahs are established. Major diversification of grassland animals and snakes. Insects diversify, especially ants and termites.
- 0.0095 BYA = 9.50 MYA, Great American Interchange occurs. Armadillos, opossums, hummingbirds, “terror birds”, and ground sloths were among the species that migrated from South America to North America after a land bridge formed between the previously isolated continents. Species moving in the opposite direction included horses, tapirs, saber-toothed cats, jaguars, bears, coaties, ferrets, otters, skunks and deer.
- 6.50 MYA, First hominins (our human ancestors diverging from the apes).
- 6.00 MYA, Australopithecines (extinct close relatives of humans after the split with chimpanzees) diversify.
- 5.00 MYA, First tree sloths and hippopotami. Diversification of grazing and carnivorous mammals.
- 4.00 MYA, Diversification of Australopithecines. The first modern elephants, giraffes, zebras, lions, rhinoceros and gazelles.
- 2.80 MYA, Appearance of a species intermediate between the Australopithecines and *Homo Habilis*.
- 2.10 MYA, First member of the genus *Homo* appears, *Homo habilis*.

3.2 Early ancestors of humans

In his *Systema Naturae*, published in 1735, Carolus Linnaeus correctly classified humans as mammals associated with the anthropoid apes. However, illustrations of possible ancestors of humans in a later book by Linnaeus, showed one with a manlike head on top of a long-haired body, and another with a tail. A century later, in 1856, light was thrown on human ancestry by the discovery of some remarkable bones in a limestone cave in the valley of Neander, near Düsseldorf - a skullcap and some associated long bones. The skullcap was clearly manlike, but the forehead was low and thick, with massive ridges over the eyes. The

famous pathologist Rudolf Virchow dismissed the find as a relatively recent pathological idiot. Other authorities thought that it was “one of the Cossacks who came from Russia in 1814”. Darwin knew of the “Neanderthal man”, but he was too ill to travel to Germany and examine the bones. However, Thomas Huxley examined them, and in his 1873 book, *Zoological Evidences of Man’s Place in Nature*, he wrote: “Under whatever aspect we view this cranium... we meet with apelike characteristics, stamping it as the most pithecoïd (apelike) of human crania yet discovered.”

“In some older strata,” Huxley continued, “do the fossilized bones of an ape more anthropoid, or a man more pithecoïd, than any yet known await the researches of some unborn paleontologist?” Huxley’s question obsessed Eugène Dubois, a young Dutch physician, who reasoned that such a find would be most likely in Africa, the home of chimpanzees and gorillas, or in the East Indies, where orang-outangs live. He was therefore happy to be appointed to a post in Sumatra in 1887. While there, Dubois heard of a site in Java where the local people had discovered many ancient fossil bones, and at this site, after much searching, he uncovered a cranium which was much too low and flat to have belonged to a modern human. On the other hand it had features which proved that it could not have belonged to an ape. Near the cranium, Dubois found a leg bone which clearly indicated upright locomotion, and which he (mistakenly) believed to belong to the same creature. In announcing his find in 1894, Dubois proposed the provocative name “*Pithecanthropus erectus*”, i.e. “upright-walking ape-man”

Instead of being praised for this discovery, Dubois was denounced. His attackers included not only the clergy, but also many scientists (who had expected that an early ancestor of man would have an enlarged brain associated with an apelike body, rather than apelike head associated with upright locomotion). He patiently exhibited the fossil bones at scientific meetings throughout Europe, and gave full accounts of the details of the site where he had unearthed them. When the attacks nevertheless continued, Dubois became disheartened, and locked the fossils in a strongbox, out of public view, for the next 28 years. In 1923, however, he released a cast of the skull, which showed that the brain volume was about 900 cm³ - well above the range of apes, but below the 1200-1600 cm³ range which characterizes modern man. Thereafter he again began to exhibit the bones at scientific meetings.

The fossil bones of about 1000 hominids, intermediate between apes and humans, have now been discovered. The oldest remains have been found in Africa. Many of these were discovered by Raymond Dart and Robert Broom, who worked in South Africa, and by Louis and Mary Leakey and their son Richard, who made their discoveries at the Olduvai Gorge in Tanzania and at Lake Rudolph in Kenya.

One can deduce from biochemical evidence that the most recent common ancestor of the anthropoid apes and of humans lived in Africa between 5 and 10 million years before the present. Although the community of palaeoanthropologists is by no means unanimous, there is reasonably general agreement that while *A. africanus* is probably an ancestor of *H. habilis* and of humans, the “robust” species, *A. aethiopicus*, *A. robustus* and *A. boisei*³

³ *A. boisei* was originally called “*Zinjanthropus boisei*” by Mary and Louis Leakey who discovered the

represent a sidebranch which finally died out. “*Pithecanthropus erectus*”, found by Dubois, is now classified as a variety of *Homo erectus*, as is “*Sinanthropus pekinensis*” (“Peking man”), discovered in 1929 near Beijing, China.

Footprints 3.7 million years old showing upright locomotion have been discovered near Laetoli in Tanzania. The Laetoli footprints are believed to have been made by *A. afarensis*, which was definitely bipedal, but upright locomotion is thought to have started much earlier. There is even indirect evidence which suggests that *A. ramidus* may have been bipedal. *Homo habilis* was discovered by Mary and Louis Leakey at the Olduvai Gorge, among beds of extremely numerous pebble tools. The Leakeys gave this name (meaning “handy man”) to their discovery in order to call special attention to his use of tools. The brain of *H. habilis* is more human than that of *A. africanus*, and in particular, the bulge of Broca’s area, essential for speech, can be seen on one of the skull casts. This makes it seem likely that *H. habilis* was capable of at least rudimentary speech.

Homo erectus was the first species of hominid to leave Africa, and his remains are found not only there, but also in Europe and Asia. “Peking man”, who belonged to this species, probably used fire. The stone tools of *H. erectus* were more advanced than those of *H. habilis*; and there is no sharp line of demarcation between the most evolved examples of *H. erectus* and early fossils of archaic *H. sapiens*.

Homo sapiens neanderthalensis lived side by side with *Homo sapiens sapiens* (modern man) for a hundred thousand years; but in relatively recent times, only 30,000 years ago, Neanderthal man disappeared. Did modern man outcompete him? Do present-day humans carry any Neanderthal genes? To what extent was modern man influenced by Neanderthal cultural achievements? Future research may tell us the answers to these questions, but for the moment they are mysteries.

The hominid species shown in Table 4.1 show an overall progression in various characteristics: Their body size and brain size grew. They began to mature more slowly and to live longer. Their tools and weapons increased in sophistication. Meanwhile their teeth became smaller, and their skeletons more gracile - less heavy in proportion to their size. What were the evolutionary forces which produced these changes? How were they rewarded by a better chance of survival?

fossil remains at the Olduvai Gorge. Charles Boise helped to finance the Leakey’s expedition.

Table 3.1: **Hominid species**

| genus and species | years before present | brain volume |
|------------------------------|----------------------|-----------------------------|
| Ardipithecus ramidus | 4.35 to 4.45 million | 300 to 350 cm ² |
| Australopithecus anamensis | 4.2 to 3.9 million | |
| Australopithecus afarensis | 3.9 to 3.0 million | 375 to 550 cm ³ |
| Australopithecus africanus | 3 to 2 million | 420 to 500 cm ³ |
| Australopithecus aethiopicus | 2.6 to 2.3 million | 410 cm ³ |
| Paranthropus robustus | 2 to 1.5 million | 410 to 530 cm ³ |
| Australopithecus boisei | 2.1 to 1.1 million | 530 cm ³ |
| Homo habilis | 2.1 to 1.5 million | 550 to 687 cm ³ |
| Homo erectus | 1.9 to 0.143 million | 750 to 1225 cm ³ |
| Homo sapiens (archaic) | 0.5 to 0.2 million | 1200 cm ³ |
| Homo sapiens neand. | 0.23 to 0.04 million | 1450 cm ³ |
| Homo sapiens sapiens | 0.12 mil. to present | 1350 cm ³ |

Table 3.2: **Paleolithic cultures**

| name | years before present | characteristics |
|-------------|----------------------|--|
| Oldowan | 2.4 to 1.5 million | Africa, flaked pebble tools |
| Choukoutien | 1.2 to 0.5 million | chopper tool culture of east Asia |
| Abbevillian | 500,000 to 450,000 | crude stone handaxes Africa, Europe, northeast Asia |
| Mousterian | 70,000 to 20,000 | produced by Neanderthal man, retouched core and flake tools, wooden spears, fire, burial of dead |
| Aurignacian | 50,000 to 20,000 | western Europe, fine stone blades, pins and awls of bone, fire, cave art |
| Solutrian | 20,000 to 17,000 | France and central Europe, long, pressure-flaked bifacial blades |
| Magdalenian | 17,000 to 10,000 | western Europe, reindeer hunting awls and needles of bone and antler |

3.3 *Ardipithicus ramidus*

17 bone fragments belonging to our distant ancestor, *A. ramidus*, were discovered in 1992-1993 by a research team headed by Tim White. The discovery was made in the Afar Depression of the Middle Awash river valley of Ethiopia. In 1994, more fragments were discovered, amounting finally to 45% of a complete skeleton. On the basis of the age of the stratum in which the bones were found, *A. ramidus* is thought to have lived between 4.35 and 4.45 years ago. This hominid walked upright, but had foot with a thumblike big toe which could grasp tree branches. *A. ramidus* had a small brain, only 300-350 cm.³, which is smaller than a modern female chimpanzee. Nevertheless, the upright locomotion of the species identifies it as a human ancestor rather than an ape.

3.4 *Australopithecus*

Australopithecus afarensis (“Lucy”)

Several hundred fossil bone fragments belonging to *A. afarensis* were discovered in 1974 in the Awash valley of Ethiopia, not far from the site where *A. ramidus* was discovered in 1992-1994. Although discovered earlier, the bones belong to one of our ancestors who lived at a later period, 3.2 million years before the present. The bones belong to a young female who was given the fanciful nickname “Lucy”, after the popular Beatles song “Lucy in the Sky With Diamonds” which was being played loudly and repeatedly at the campsite of the discoverers⁴.

Lucy was 1.1 meters tall, (3 feet and 7 inches), with a brain-size comparable to a modern chimpanzee, but her upright locomotion marked her as a human ancestor rather than an ape. She had long arms in relation to the length of her legs, although not so long as those of a chimpanzee.

Homo habilis (“handy man”)

Louis Leakey (father of Richard Leakey), and his wife, Mary Leakey, found the first trace of *H. habilis* in 1955: two hominin teeth. These were later classified as “milk teeth”, and therefore considered difficult to link to taxa, unlike permanent teeth. However, in 1959, Mary Leakey recovered the cranium of a young adult that had a small brain, large face, tiny canines and massive chewing teeth. The remains were associated with stone tools of the Oldowan type. In 1964 the fossils were identified as a separate species and given the name *Homo habilis*.

Short in stature, with disproportionately long arms compared with *H. sapiens*, and a brain about half the size of that of modern humans, *H. habilis* was very apelike, and many palaeoanthropologists believe that the species ought to be classified with the Australop-

⁴Donald Johanson, Mary Leaky, Yves Coppens and their team.

ithicenes. On the other hand, the relatively advanced stone tools and omnivorous diet of *H. habilis* support the classification of the species within the genus *Homo*.

Homo erectus

As mentioned above, the first fossil remains of *H. erectus* were discovered in Sumatra in 1857 by the young Dutch physician, Eugène Dubois. Most paleoanthropologists believe that *H. erectus* evolved in Africa, and was the first hominin to leave that continent, during a period when the climates of Africa and the Middle East were more favorable to migration than they later became. However, there is a minority school of thought that maintains that *H. erectus* evolved in Asia. In any case the species survived in Asia until only 143,000 years before the present, and was able to use fire.

Homo neanderthalensis

The species *H. neanderthalensis* (“Neanderthal Man”) takes its name from the mountain valley near to Düsseldorf where fossil remains were discovered in 1856.⁵ The presence in the Middle East of this successful and physically powerful species is probably the reason why the first attempts of *H. sapiens* to leave Africa failed.

The Wikipedia article on *Homo heidelbergensis* states that “Neanderthals, Denisovans, and modern humans are all considered to have descended from *Homo heidelbergensis* that appeared around 700,000 years ago in Africa. Fossils have been recovered in Ethiopia, Namibia and South Africa. Between 400,000 and 300,000 years ago a group of *Homo heidelbergensis* migrated into Europe and West Asia via yet unknown routes and eventually evolved into Neanderthals.”

Denisovans are eastern cousin of the Neanderthals, and the genes of both species have been sequenced by Prof. Svante Pääbo and his colleagues at the Max Planck Institute for Evolutionary Anthropology. The results of these studies show that the genomes of modern humans outside of Africa contain an appreciable amount of genetic information derived from interbreeding with Neanderthals and Denisovans.

⁵Earlier fossils of *H. neanderthalensis* were discovered in Belgium in 1829, and in Gibraltar in 1848, but the importance of these discoveries was not recognized.



Figure 3.1: *Australopithecus afarensis*. One famous member of this species, nicknamed “Lucy”, was 1.1 meters tall and lived 3.2 million years ago.



Figure 3.2: *Australopithecus afarensis*: a hunting scene. Males of the species are seen here using weapons and cooperative tactics.



Figure 3.3: **Homo habilis**, “handy man”, was very apeline in size and appearance, but used a more advanced toolkit than previous hominins.



Figure 3.4: **Homo habilis** is seen here making and using tools.



Figure 3.5: **Homo erectus** left Africa, and spread throughout Eurasia, as far as Georgia, Armenia, India, Sri Lanka, China and Indonesia.



Figure 3.6: **Homo erectus** using fire.

3.5 Y-chromosomal DNA and mitochondrial DNA

Recent DNA studies have cast much light on human prehistory, and especially on the story of how a small group of anatomically and behaviorally modern humans left Africa and populated the remainder of the world. Two types of DNA have been especially useful - Y-chromosomal DNA and mitochondrial DNA.

When we reproduce, the man's sperm carries either an X chromosome or a Y chromosome. It is almost equally probable which of the two it carries. The waiting egg of the mother has an X chromosome with complete certainty. When the sperm and egg unite to form a fertilized egg and later an embryo, the YX combinations become boys while the XX combinations become girls. Thus every male human carries a Y chromosome inherited from his father, and in fact this chromosome exists in every cell of a male's body.

Humans have a total of 23 chromosomes, and most of these participate in what might be called the "genetic lottery" - part of the remaining 22 chromosomes come from the father, and part from the mother, and it is a matter of chance which parent contributes which chromosome. Because of this genetic lottery, no two humans are genetically the same, except in the case of identical twins. This diversity is a great advantage, not only because it provides natural selection variation on which to act, but also it because prevents parasites from mimicking our cell-surface antigens and thus outwitting our immune systems. In fact the two advantages of diversity just mentioned are so great that sexual reproduction is almost universal among higher animals and plants.

Because of its special role in determining the sex of offspring, the Y chromosome is exempted from participation in the genetic lottery. This makes it an especially interesting object of study because the only changes that occur in Y chromosomes as they are handed down between generations are mutations. These mutations are not only infrequent but they also happen at a calculable rate. Thus by studying Y-chromosomal lineages, researchers have been able not only to build up prehistoric family trees but also to assign dates to events associated with the lineages.

The mutation M168 seems to have occurred just before the ancestral population of anatomically and behaviorally modern humans left Africa, roughly 60,000 years ago. All of the men who left Africa at that time carried this mutation. The descendents of this small group, probably a single tribe, were destined to populate the entire world outside Africa.

After M168, further mutations occurred, giving rise to the Y-chromosomal groups C, D, E and F-R. Men carrying Y chromosomes of type C migrated to Central Asia, East Asia and Australia/New Guinea. The D group settled in Central Asia, while men carrying Y chromosomes of type E can be found today in East Asia, Sub-Saharan Africa, the Middle East, West Eurasia, and Central Asia. Populations carrying Y chromosomes of types F-R migrated to all parts of the world outside Africa. Those members of population P who found their way to the Americas carried the mutation M242. Only indigenous men of the Americas have Y chromosomes with M242.

Mitochondrial DNA is present in the bodies of both men and women, but is handed on only from mother to daughter. The human family tree constructed from mutations in

mitochondrial DNA is closely parallel to the tree constructed by studying Y chromosomes. In both trees we see that only a single small group left Africa, and that the descendants of this small group populated the remainder of the world. The mitochondrial groups L1a, L1b, and L2 are confined to Sub-Saharan Africa, but by following the lineage L3 we see a path leading out of Africa towards the population of the remainder of the world, as is shown in the next figure.

While the unmutated L3 lineage remained in Africa, a slightly changed group of people found their way out. It seems to have been a surprisingly small group, perhaps only a single tribe. Their descendants populated the remainder of the world. The branching between the N and M lineages occurred after their exodus from Africa. All women in Western Eurasia are daughters of the N line, while in Eastern Eurasia women are descended from both the N and M lineages. Daughters of both N and M reached the Americas.

Mitochondrial DNA is also exempted from participation in the genetic lottery, but for a different reason. Mitochondria were once free-living eubacteria of a type called alpha-proteobacteria. These free-living bacteria were able to perform oxidative phosphorylation, i.e. they could couple the combustion of glucose to the formation of the high-energy phosphate bond in ATP. When photosynthesis evolved, the earth's atmosphere became rich in oxygen, which was a deadly poison to most of the organisms alive at the time. Two billion years ago, when atmospheric oxygen began to increase in earnest, many organisms retreated into anaerobic ecological niches, while others became extinct; but some survived the oxygen crisis by incorporating alpha-proteobacteria into their cells and living with them symbiotically. Today, mitochondria living as endosymbionts in all animal cells, use oxygen constructively to couple the burning of food with the synthesis of ATP. As a relic of the time when they were free-living bacteria, mitochondria have their own DNA, which contained within them rather than within the cell nuclei.

When a sperm and an egg combine, the sperm's mitochondria are lost; and therefore all of the mitochondria in the body of a human child come from his or her mother. Just as Y-chromosomal DNA is passed essentially unchanged between generations in the male lines of a family tree, mitochondrial DNA is passed on almost without change in the female lines. The only changes in both cases are small and infrequent mutations. By estimating the frequency of these mutations, researchers can assign approximate dates to events in human prehistory.

On the female side of the human family tree, all lines lead back to a single woman, whom we might call "Mitochondrial Eve". Similarly, all the lines of the male family tree lead back to a single man, to whom we can give the name "Y-Chromosomal Adam". ("Eve" and "Adam" were not married, however; they were not even contemporaries!)

But why do the female and male family trees both lead back to single individuals? This has to do with a phenomenon called "genetic drift". Sometimes a man will have no sons, and in that case, his male line will end, thus reducing the total number of Y-chromosomes in the population. Finally, after many generations, all Y-chromosomes will have dropped away through the ending of male lines except those that can be traced back to a single individual. Similar considerations hold for female lines.

When did Y-Chromosomal Adam walk the earth? Peter Underhill and his colleagues

Table 3.3: Events leading up to the dispersal of fully modern humans from Africa (a model proposed by Sir Paul Mellars).

| Years before present | Event |
|----------------------|--|
| 150,000-200,000 BP | Initial emergence of anatomically modern populations in Africa |
| 110,000-90,000 BP | Temporary dispersal of anatomically modern populations (with Middle Paleolithic technology) from Africa to southwest Asia, associated with clear symbolic expression |
| 80,000-70,000 BP | Rapid climatic and environmental changes in Africa |
| 80,000-70,000 BP | Major technological, economic and social changes in south and east Africa |
| 70,000-60,000 BP | Major population expansion in Africa from small source area |
| ca. 60,000 BP | Dispersal of modern populations from Africa to Eurasia |

at Stanford University calculate that, on the basis of DNA evidence, Adam lived between 40,000 and 140,000 years before the present (BP). However, on the basis of other evidence (for example the dating of archaeological sites in Australia) 40,000 years BP can be ruled out as being much too recent. Similar calculations on the date of Mitochondrial Eve find that she lived very approximately 150,000 years BP, but again there is a wide error range.



Figure 3.7: *Homo neandrithalensis*. In 1997, Prof. Dr. Svante Pääbo and his colleagues at the Max Planck Institute for Evolutionary Anthropology reported their successful sequencing of Neanderthal mitochondrial DNA. Later they sequenced the DNA of Denisovans, the eastern cousins of the Neanderthals. They were also able to show that 3-5% of the DNA of humans living outside Africa is shared with Neanderthals and Denisovans, indicating intermarriage, or at least interbreeding.



Figure 3.8: *Homo neandrihalensis* working happily in front of his dwelling. The brain size of Neanderthals was larger than that of modern humans, but their linguistic abilities may have been inferior to those of *H. sapiens sapiens*. The Neanderthals survived in Spain until 40,000 years ago. They are, in a sense, alive today, since their genes have been mixed with those of modern humans.

3.6 Exodus: Out of Africa

A model for the events leading up to the exodus of fully modern humans from Africa has been proposed by Sir Paul Mellars of Cambridge University, and it is shown in Table 4.3. In the article on which this table is based, Mellars calls our attention to archaeological remains of anatomically modern humans at the sites of Skhul and Qafzeh in what is now northern Israel. The burials have been dated as having taken place 110,000-90,000 BP, and they show signs of cultural development, including ceremonial arrangement with arms folded, and sacrificial objects such as pierced shell ornaments. This early exodus was short-lived, however, probably because of competition with the long-established Neanderthal populations in the region.

In Mellars' model, rapid climatic and environmental changes took place in Africa during the period 80,000-70,000 BP. According to the Toba Catastrophe Theory⁶ the climatic changes in Mellars' model were due to the eruption of a supervolcano at the site of what is now Lake Toba in Indonesia. This eruption, one of the largest known to us, took place ca. 73,000 BP, and plunged the earth into a decade of extreme cold, during which the population of our direct ancestors seem to have been reduced to a small number, perhaps

⁶The Toba Catastrophe Theory is supported by such authors as Ann Gibbons, Michael R. Rampino and Steven Self

as few as 10,000 individuals⁷.

The survivors of the Toba Catastrophe may have been selected for improved linguistic ability, which gave them a more advanced culture than their contemporaries. Mellers points to archaeological and genetic evidence that a major population expansion of the L2 and L3 mitochondrial lineages took place in Africa 70,000-60,000 BP, starting from a small source region in East Africa, and spreading west and south. The expanding L2 and L3 populations were characterized by advanced cultural features such as upper paleolithic technology, painting and body ornaments.

All researchers agree that it was a small group of the L3 mitochondrial lineage that made the exodus from Africa, but there is some disagreement about the date of this event. These differences reflect the intrinsic inaccuracy of the genetic dating methods, but all researchers agree that the group passing out of Africa was remarkably small, especially when we reflect that the entire population of the remainder of the world is descended from them.

The small group of modern humans leaving Africa probably crossed the Red Sea at its narrowest point⁸. The men in this tiny but brave group of explorers carried with them the Y-chromosomal mutation M168, while the women were of the mitochondrial lineage L3. Shortly after they crossed the Red Sea (like Moses and his followers), a mutation occurred and two new mitochondrial lineages were established, M and N. All women today in Western Eurasia are daughters of the N lineage⁹, while the M lineage spread to the entire world outside Africa. The mitochondrial lineages M and N had further branches, and daughters of the A, B, C, D and X lineages passed over a land bridge which linked Siberia to Alaska during the period 22,000-7,000 BP, thus reaching the Americas.

⁷Additional support to the Toba Catastrophe Theory comes from DNA studies of mammals, such as chimpanzees, orangutans, macques, cheetahs, tigers and gorillas. These mammals also seem, on the basis of DNA studies, to have been reduced to very small populations at the time of the Toba eruption.

⁸Today this narrow place is sometimes called "Gate of Grief" because many shipwrecks take place there.

⁹Of course, this broad statement does not take into account the movements of peoples that have taken place during historic times.

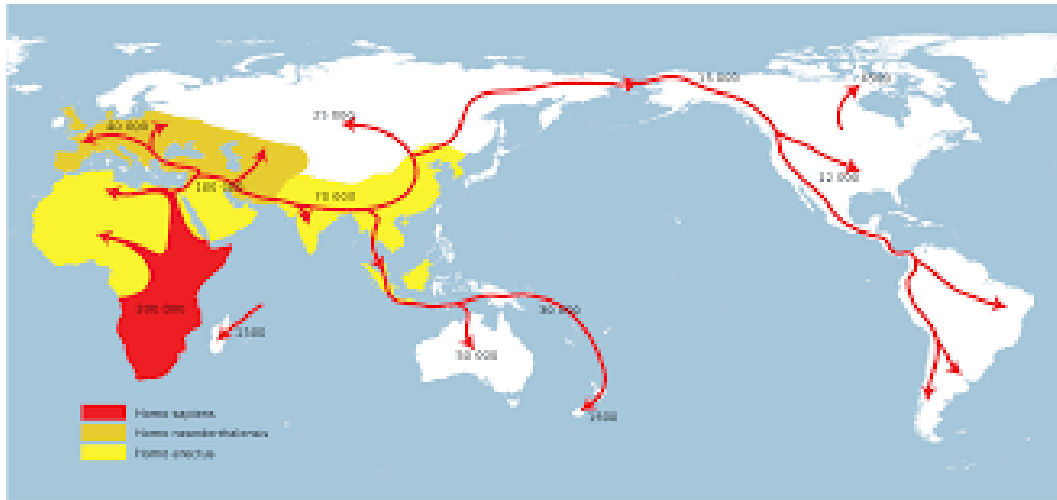

Figure 3.9: The spread of *Homo sapiens*



Figure 3.10: Domestication of the dog



Figure 3.11: Paleolithic cave paintings as old as 40,000 years before the present have been found in many parts of the world. Those shown here are from the Dordogne region of France. Perhaps these paintings were made to ensure the success of hunts for the animals shown.



Figure 3.12: Another painting from the same cave in France.



Figure 3.13: Cave paintings made using human hands as stencils. The artist's mouth was filled with paint, and this was blown onto the rock.



Figure 3.14: Cave paintings showing the use of bows and arrows in hunting.



Figure 3.15: Paleolithic stone tools



Figure 3.16: Neolithic stone tools were more advanced. Stone axes were highly polished and had holes to accommodate the hafts.



Figure 3.17: A Neolithic scene.



Figure 3.18: About 10,000 years ago, during a period of exceptional climatic stability, agriculture was invented independently in several parts of the world. It spread rapidly, revolutionizing human life, and making much larger population densities possible. Here we see agriculture in ancient Egypt. It also supported advanced civilizations in Mesopotamia, China and India, as well as in Central and South America.

Suggestions for further reading

1. D.R. Griffin, *Animal Mind - Human Mind*, Dahlem Konferenzen 1982, Springer, Berlin, (1982).
2. S. Savage-Rumbaugh, R. Lewin, et al., *Kanzi: The Ape at the Brink of the Human Mind*, John Wiley and Sons, New York, (1996).
3. R. Dunbar, *Grooming, Gossip, and the Evolution of Language*, Harvard University Press, (1998).
4. J.H. Greenberg, *Research on language universals*, Annual Review of Anthropology, 4, 75-94 (1975).
5. M.E. Bitterman, *The evolution of intelligence*, Scientific American, January, (1965).
6. R. Fox, *In the beginning: Aspects of hominid behavioral evolution*, Man, NS 2, 415-433 (1967).
7. M.S. Gazzaniga, *The split brain in man*, Scientific American, 217, 24-29 (1967).
8. D. Kimura, *The asymmetry of the human brain*, Scientific American, 228, 70-78 (1973).
9. R.G. Klein, *Anatomy, behavior, and modern human origins*, Journal of World Prehistory, 9 (2), 167-198 (1995).
10. N.G. Jablonski and L.C. Aiello, editors, *The Origin and Diversification of Language*, Wattis Symposium Series in Anthropology. Memoirs of the California Academy of Sciences, No. 24, The California Academy of Sciences, San Francisco, (1998).
11. S. Pinker, *The Language Instinct: How the Mind Creates Language*, Harper-Collins Publishers, New York, (1995).

12. S. Pinker, *Talk of genetics and visa versa*, *Nature*, 413, 465-466, (2001).
13. S. Pinker, *Words and rules in the human brain*, *Nature*, 387, 547-548, (1997).
14. J.H. Barkow, L. Cosmides and J. Tooby, editors, *The Adapted Mind: Evolutionary Psychology and the Generation of Culture*, Oxford University Press, (1995).
15. D.R. Begun, C.V. Ward and M.D. Rose, *Function, Phylogeny and Fossils: Miocene Hominid Evolution and Adaptations*, Plenum Press, New York, (1997).
16. R.W. Byrne and A.W. Whitten, *Machiavellian Intelligence: Social Expertise and the Evolution of Intellect in Monkeys, Apes and Humans*, Cambridge University Press, (1988),
17. V.P. Clark, P.A. Escholz and A.F. Rosa, editors, *Language: Readings in Language and Culture*, St Martin's Press, New York, (1997).
18. T.W. Deacon, *The Symbolic Species: The Co-evolution of Language and the Brain*, W.W. Norton and Company, New York, (1997).
19. C. Gamble, *Timewalkers: The Prehistory of Global Colonization*, Harvard University Press, (1994).
20. K.R. Gibson and T. Ingold, editors, *Tools, Language and Cognition in Human Evolution*, Cambridge University Press, (1993).
21. P. Mellers, *The Emergence of Modern Humans: An Archeological Perspective*, Edinburgh University Press, (1990).
22. P. Mellers, *The Neanderthal Legacy: An Archeological Perspective of Western Europe*, Princeton University Press, (1996).
23. S. Mithen, *The Prehistory of the Mind*, Thames and Hudson, London, (1996).
24. D. Haraway, *Signs of dominance: from a physiology to a cybernetics, of primate biology*, C.R. Carpenter, 1939-1970, *Studies in History of Biology*, 6, 129-219 (1983).
25. D. Johanson and M. Edey, *Lucy: The Beginnings of Humankind*, Simon and Schuster, New York, (1981).
26. B. Kurten, *Our Earliest Ancestors*, Colombia University Press, New York, (1992).
27. R. Lass, *Historical Linguistics and Language Change*, Cambridge University Press, (1997).
28. R.E. Leakey and R. Lewin, *Origins Reconsidered*, Doubleday, New York, (1992).
29. P. Lieberman, *The Biology and Evolution of Language*, Harvard University Press, (1984).
30. C.S.L. Lai, S.E. Fisher, J.A. Hurst, F. Vargha-Khadems, and A.P. Monaco, *A forkhead-domain gene is mutated in a severe speech and language disorder*, *Nature*, 413, 519-523, (2001).
31. W. Enard, M. Przeworski, S.E. Fisher, C.S.L. Lai, V. Wiebe, T. Kitano, A.P. Monaco, and S. Paabo, *Molecular evolution of FOXP2, a gene involved in speech and language*, *Nature AOP*, published online 14 August 2002.
32. M. Gopnik and M.B. Crago, *Familial aggregation of a developmental language disorder*, *Cognition*, 39, 1-50 (1991).
33. K.E. Watkins, N.F. Dronkers, and F. Vargha-Khadem, *Behavioural analysis of an inherited speech and language disorder. Comparison with acquired aphasia*, *Brain*, 125, 452-464 (2002).

34. J.D. Wall and M. Przeworski, *When did the human population size start increasing?*, *Genetics*, 155, 1865-1874 (2000).
35. L. Aiello and C. Dean, *An Introduction to Human Evolutionary Anatomy*, Academic Press, London, (1990).
36. F. Ikawa-Smith, ed., *Early Paleolithic in South and East Asia*, Mouton, The Hague, (1978).
37. M. Aitken, *Science Based Dating in Archeology*, Longman, London, (1990).
38. R.R. Baker, *Migration: Paths Through Space and Time*, Hodder and Stoughton, London, (1982).
39. P. Bellwood, *Prehistory of the Indo-Malaysian Archipelago*, Academic Press, Sidney, (1985).
40. P.J. Bowler, *Theories of Human Evolution: A Century of Debate, 1884-1944*, Basil Blackwell, Oxford, (1986).
41. G. Isaac and M. McCown, eds., *Human Origins: Louis Leaky and the East African Evidence*, Benjamin, Menlo Park, (1976).
42. F.J. Brown, R. Leaky, and A. Walker, *Early Homo erectus skeleton from west Lake Turkana, Kenya*, *Nature*, 316, 788-92 (1985).
43. K.W. Butzer, *Archeology as Human Ecology*, Cambridge University Press, (1982).
44. A.T. Chamberlain and B.A. Wood, *Early hominid phylogeny*, *Journal of Human Evolution*, 16, 119-33, (1987).
45. P. Mellars and C. Stringer, eds., *The Human Revolution: Behavioural and Biological Perspectives in the Origins of Modern Humans*, Edinburgh University Press, (1989).
46. G.C. Conroy, *Primate Evolution*, W.W. Norton, New York, (1990).
47. R.I.M. Dunbar, *Primate Social Systems*, Croom Helm, London, (1988).
48. B. Fagan, *The Great Journey: The Peopling of Ancient America*, Thames and Hudson, London, (1987).
49. R.A. Foley, ed., *Hominid Evolution and Community Ecology*, Academic Press, New York, (1984).
50. S.R. Binford and L.R. Binford, *Stone tools and human behavior*, *Scientific American*, 220, 70-84, (1969).
51. G. Klein, *The Human Career, Human Biological and Cultural Origins*, University of Chicago Press, (1989).
52. B.F. Skinner and N. Chomsky, *Verbal behavior*, *Language*, 35, 26-58 (1959).
53. D. Bickerton, *The Roots of Language*, Karoma, Ann Arbor, Mich., (1981).
54. E. Lenneberg in *The Structure of Language: Readings in the Philosophy of Language*, J.A. Fodor and J.A. Katz editors, Prentice-Hall, Englewood Cliffs N.J., (1964).
55. M. Ruhelen, *The Origin of Language*, Wiley, New York, (1994).
56. C.B. Stringer and R. McKie, *African Exodus: The Origins of Modern Humanity*, Johnathan Cape, London (1996).
57. R. Lee and I. DeVore, editors, *Kalahari Hunter-Gatherers*, Harvard University Press, (1975).
58. R.W. Sussman, *The Biological Basis of Human Behavior*, Prentice Hall, Englewood Cliffs, (1997).

Chapter 4

AGRICULTURE

4.1 Accelerating cultural evolution

An acceleration of human cultural development seems to have begun approximately 40,000 years ago. The first art objects date from that period, as do migrations which ultimately took modern man across the Bering Strait to the western hemisphere. A land bridge extending from Siberia to Alaska is thought to have been formed approximately 70,000 years ago, disappearing again roughly 10,000 years before the present. Cultural and genetic studies indicate that migrations from Asia to North America took place during this period. Shamanism,¹ which is found both in Asia and the new world, as well as among the Sami (Lapps) of northern Scandinavia, is an example of the cultural links between the hunting societies of these regions.

In the caves of Spain and southern France are the remains of vigorous hunting cultures which flourished between 30,000 and 10,000 years ago. The people of these upper Paleolithic cultures lived on the abundant cold-weather game which roamed the southern edge of the ice sheets during the Wurm glacial period: huge herds of reindeer, horses and wild cattle, as well as mammoths and woolly rhinos. The paintings found in the Dordogne region of France, for example, combine decorative and representational elements in a manner which contemporary artists might envy. Sometimes among the paintings are stylized symbols which can be thought of as the first steps towards writing.

In this period, not only painting, but also tool-making and weapon-making were highly developed arts. For example, the Solutrian culture, which flourished in Spain and southern France about 20,000 years ago, produced beautifully worked stone lance points in the shape of laurel leaves and willow leaves. The appeal of these exquisitely pressure-flaked blades must have been aesthetic as well as functional. The people of the Solutrian culture had fine bone needles with eyes, bone and ivory pendants, beads and bracelets, and long bone pins with notches for arranging the hair. They also had red, yellow and black pigments

¹ A shaman is a special member of a hunting society who, while in a trance, is thought to be able to pass between the upper world, the present world, and the lower world, to cure illnesses, and to insure the success of a hunt.



Figure 4.1: A cave painting showing a domesticated dog.

for painting their bodies. The Solutrian culture lasted for 4,000 years. It ended in about 17,000 B.C. when it was succeeded by the Magdalenian culture. Whether the Solutrian people were conquered by another migrating group of hunters, or whether they themselves developed the Magdalenian culture we do not know.

Wikipedia states that “The dog diverged from a now-extinct population of wolves immediately before the Last Glacial Maximum, when much of Eurasia was a cold, dry mammoth steppe biome.... The archaeological record shows the first undisputed dog remains buried beside humans 14,700 years ago, with disputed remains occurring 36,000 years ago. These dates imply that the earliest dogs arose in the time of human hunter-gatherers and not agriculturalists. The dog was the first species to be domesticated.”

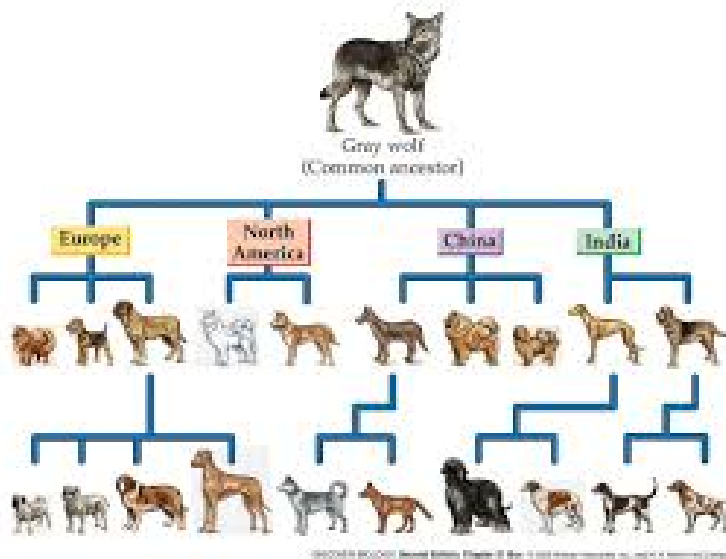

Figure 4.2: The family tree of dogs, showing their descent from the grey wolf.



Figure 4.3: Neolithic humans hunting a mammoth with the help of dogs.

4.2 Early agriculture in the Middle East

Beginning about 10,000 B.C., the way of life of the hunters was swept aside by a great cultural revolution: the invention of agriculture. The earth had entered a period of unusual climatic stability, and this may have helped to make agriculture possible. The first agricultural villages date from this time, as well as the earliest examples of pottery. Dogs and reindeer were domesticated, and later, sheep and goats. Radio-carbon dating shows that by 8,500 B.C., people living in the caves of Shanidar in the foothills of the Zagros mountains in Iran had domesticated sheep. By 7,000 B.C., the village farming community at Jarmo in Iraq had domesticated goats, together with barley and two different kinds of wheat.

Starting about 8000 B.C., rice came under cultivation in East Asia. This may represent an independent invention of agriculture, and agriculture may also have been invented independently in the western hemisphere, made possible by the earth's unusually stable climate during this period. At Jericho, in the Dead Sea valley, excavations have revealed a prepottery neolithic settlement surrounded by an impressive stone wall, six feet wide and twelve feet high. Radiocarbon dating shows that the defenses of the town were built about 7,000 B.C. Probably they represent the attempts of a settled agricultural people to defend themselves from the plundering raids of less advanced nomadic tribes.

Starting in western Asia, the neolithic agricultural revolution swept westward into Europe, and eastward into the regions that are now Iran and India. By 4,300 B.C., the agricultural revolution had spread southwest to the Nile valley, where excavations along the shore of Lake Fayum have revealed the remains of grain bins and silos. The Nile carried farming and stock-breeding techniques slowly southward, and wherever they arrived, they swept away the hunting and food-gathering cultures. By 3,200 B.C. the agricultural revolution had reached the Hyrax Hill site in Kenya. At this point the southward movement of agriculture was stopped by the swamps at the headwaters of the Nile. Meanwhile, the Mediterranean Sea and the Danube carried the revolution westward into Europe. Between 4,500 and 2,000 B.C. it spread across Europe as far as the British Isles and Scandinavia.

However, western Asia was only one of the places where the agricultural revolution took place. Wikipedia states that "Agriculture began independently in different parts of the globe, and included a diverse range of taxa. At least eleven separate regions of the Old and New World were involved as independent centers of origin.

"Wild grains were collected and eaten from at least 20,000 BC. From around 9,500 BC, the eight Neolithic founder crops - emmer wheat, einkorn wheat, hulled barley, peas, lentils, bitter vetch, chick peas, and flax - were cultivated in the Levant. Rice was domesticated in China between 11,500 and 6,200 BC, followed by mung, soy and azuki beans. Pigs were domesticated in Mesopotamia around 11,000 BC, followed by sheep between 11,000 and 9,000 BC. Cattle were domesticated from the wild aurochs in the areas of modern Turkey and Pakistan around 8,500 BC. Sugarcane and some root vegetables were domesticated in New Guinea around 7,000 BC. Sorghum was domesticated in the Sahel region of Africa by 5,000 BC. In the Andes of South America, the potato was domesticated between 8,000 and 5,000 BC, along with beans, coca, llamas, alpacas, and guinea pigs. Bananas were

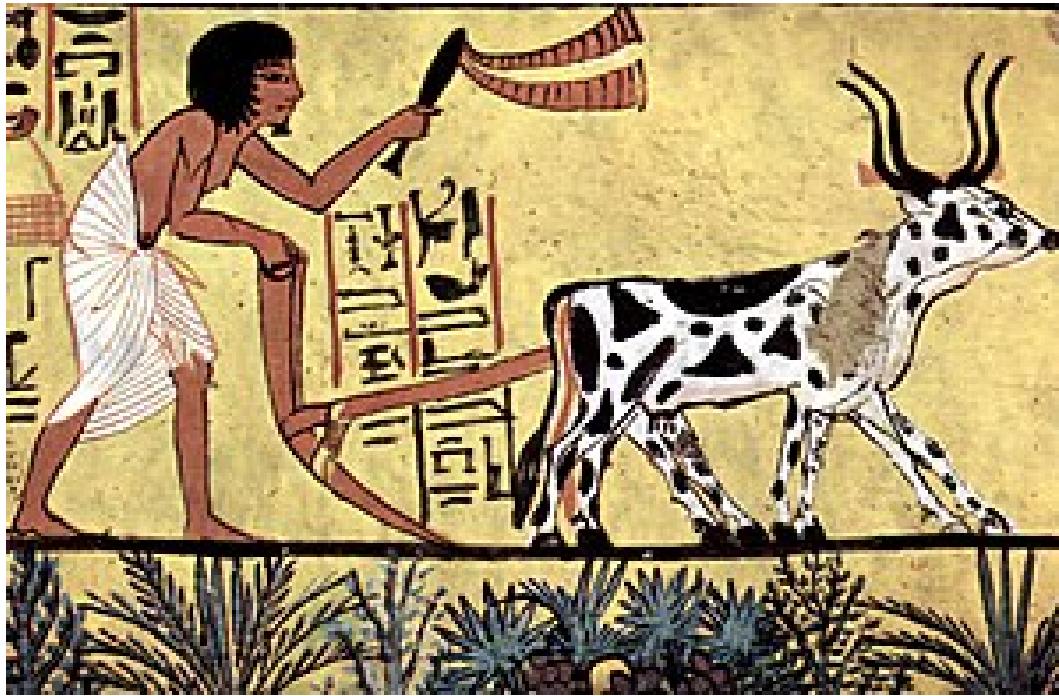

Figure 4.4: Early agriculture in Egypt: Plowing



Figure 4.5: Early agriculture in Egypt: Threshing



Figure 4.6: Pigs were domesticated in Mesopotamia around 11,000 BC.

cultivated and hybridized in the same period in Papua New Guinea. In Mesoamerica, wild teosinte was domesticated to maize by 4,000 BC. Cotton was domesticated in Peru by 3,600 BC. Camels were domesticated late, perhaps around 3,000 BC.”



Figure 4.7: Domestication of sheep.

4.3 Rice cultivation in Asia

Wikipedia states that “Excavations at Kuahuqiao, the earliest known Neolithic site in eastern China, have documented rice cultivation 7,700 years ago. Approximately half of the plant remains belonged to domesticated japonica species, whilst the other half were wild types of rice. It is possible that the people at Kuahuqiao also cultivated the wild type. Finds at sites of the Hemudu Culture (c.5500-3300 BCE) in Yuyao and Banpo near Xi’an include millet and spade-like tools made of stone and bone. Evidence of settled rice agriculture has been found at the Hemudu site of Tianluoshan (5000-4500 BCE), with rice becoming the backbone of the agricultural economy by the Majiabang culture in southern China.”

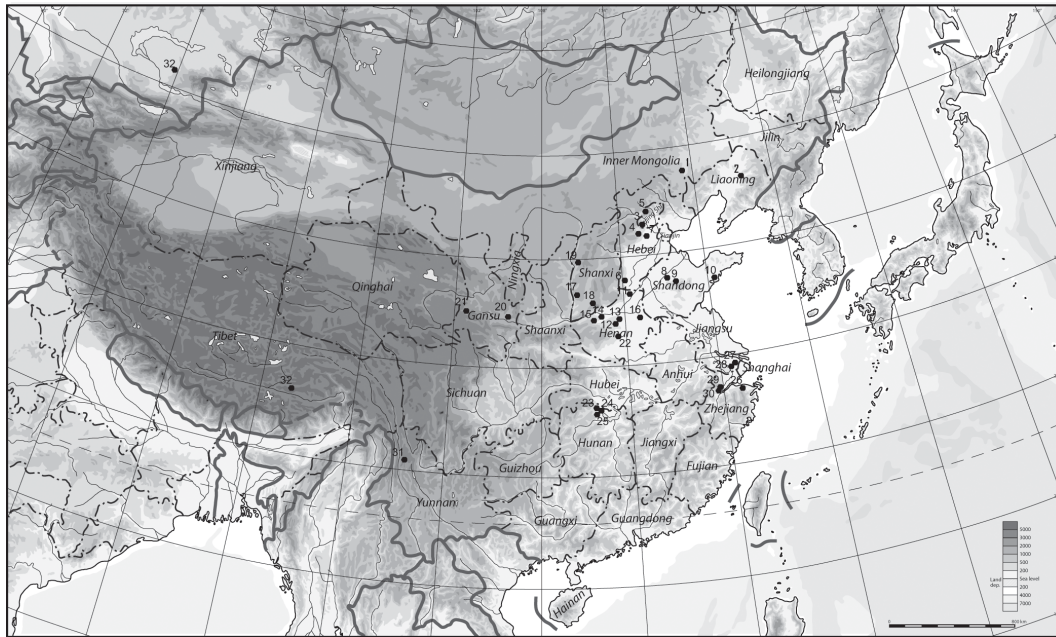

Figure 4.8: A map showing sites of early rice-growing in China.



Figure 4.9: Ancient rice terraces in Yuanyang, Yunnan, a province in southern China.

4.4 Agriculture in the western hemisphere

During a glacial period between 20,000 and 10,000 years before the present, there was a land bridge across the Bering Strait. There is evidence that humans crossed this land bridge from Siberia and followed a coastal route past the glaciated regions of what is now Canada, finally reaching South America. Humans were able to build boats at that time, as evidenced by traces of very early settlements on islands off the coast of South America.

In a May 24, 2017 article in *Science*, Lizzie Wade wrote:

“About 600 kilometers north of Lima, an imposing earthen mound looms over the sea. People began building the ceremonial structure, called Huaca Prieta, about 7800 years ago. But according to a new study, the true surprise lies buried deep beneath the 30-meter-tall mound: stone tools, animal bones, and plant remains left behind by some of the earliest known Americans nearly 15,000 years ago. That makes Huaca Prieta one of the oldest archaeological sites in the Americas and suggests that the region’s first migrants may have moved surprisingly slowly down the coast.

“The evidence of early human occupation stunned Tom Dillehay, an archaeologist at Vanderbilt University in Nashville who led the new study. Initially, he was interested in examining the mound itself. But geologists on his team wanted to study the landform under the mound, so ‘we just kept going down,’ he says. The deepest pit, which took 5 years to excavate, reached down 31 meters. Shockingly, those deep layers contained telltale signs of human occupation, Dillehay’s team reports today in *Science Advances*: evidence of hearth fires, animal bones, plant remains, and simple but unmistakable stone tools. Radiocarbon dates from charcoal place the earliest human occupation at nearly 15,000 years ago.

“That’s made some researchers say Huaca Prieta should join the small but growing list of pre-14,000-year-old sites that have revolutionized scientists’ vision of the earliest Americans. Archaeologists used to think that people walked from Siberia through an ice-free passage down Alaska and Canada, reaching the interior of the United States about 13,000 years ago. In recent years, however, well documented earlier sites like Chile’s Monte Verde have convinced most archaeologists that humans made it deep into the Americas by 14,500 years ago, meaning that they would have had to cross Canada long before an ice-free corridor existed. That would have left them with one logical route into the Americas: down the Pacific coast. But direct evidence for such a migration is lacking.”

Another site that shows evidence of early human presence is Piki Mach’ay cave in Peru. Radiocarbon dates from this cave give a human presence ranging from 22,200 to 14,700 years ago, but this evidence has been disputed. Wikipedia states that “Piki Mach’ay yielded some of the oldest plant remains in Peru, including an 11,000 year old bottle gourd. Strata from later periods at the site revealed fishtail points, manos, and metates. Plant remains indicate that, before 3,000 years BCE, amaranth, cotton, gourds, lucuma, quinoa, and squash were cultivated in the Ayacucho Basin before 3,000 years BCE. By 4,000 years BCE corn (*Zea mays*) and common beans were grown. Chili remains date from 5,500 to 4,300 years BCE. The large amounts of guinea pig bones suggest possible



Figure 4.10: The “three sisters”, maize, squash and beans, traditionally grown by tribes of the first people in North America.

domestication, and llamas may have been domesticated by 4,300 to 2,800 years BCE.”



Figure 4.11: An artist's guess at what the inhabitants of Piki Mach'ay cave in Peru might have looked like.

4.5 Peru gives potatoes to the world

Wikipedia states that “Cultivation of potatoes in South America may go back 10,000 years, yet the tubers do not preserve well in archaeological record, and there are problems with exact identification of those that are found... In the Altiplano, potatoes provided the principal energy source for the Inca Empire, its predecessors, and its Spanish successor... Potato was the staple food of most Pre-Columbian Mapuches², ‘specially in the southern and coastal [Mapuche] territories where maize did not reach maturity”

²The Mapuche are a group of indigenous inhabitants of south-central Chile and southwestern Argentina, including parts of present-day Patagonia.



Figure 4.12: In the mountainous regions of Peru, the ancient Incas built terraces for the cultivation of potatoes.



Figure 4.13: Sir Walter Raleigh presented potatoes to Queen Elizabeth I.



Figure 4.14: The Irish potato famine.



Figure 4.15: Vincent Van Gogh's painting, "The Potato Eaters".

4.6 The threat of widespread famine

“Unless progress with agricultural yields remains very strong, the next century will experience human misery that, on a sheer numerical scale, will exceed everything that has come before”

Nobel Laureate Norman Borlaug speaking of a global food crisis in the 21st century

As glaciers melt in the Himalayas, depriving India and China of summer water supplies; as sea levels rise, drowning the fertile rice fields of Viet Nam and Bangladesh; as drought threatens the productivity of grain-producing regions of North America; and as the end of the fossil fuel era impacts modern high-yield agriculture, there is a threat of wide-spread famine. There is a danger that the 1.5 billion people who are undernourished today will not survive an even more food-scarce future.

People threatened with famine will become refugees, desperately seeking entry into countries where food shortages are less acute. Wars, such as those currently waged in the Middle East, will add to the problem.

What can we do to avoid this crisis, or at least to reduce its severity? We must urgently address the problem of climate change; and we must shift money from military expenditure to the support of birth control programs and agricultural research. We must also replace the institution of war by a system of effective global governance and enforceable international laws.

Optimum population in the distant future

What is the optimum population of the world? It is certainly not the maximum number that can be squeezed onto the globe by eradicating every species of plant and animal that cannot be eaten. The optimum global population is one that can be supported in comfort, equality and dignity - and with respect for the environment.



Figure 4.16: Today, glaciers are melting rapidly many places in the world. The summer water supplies of both India and China are threatened.

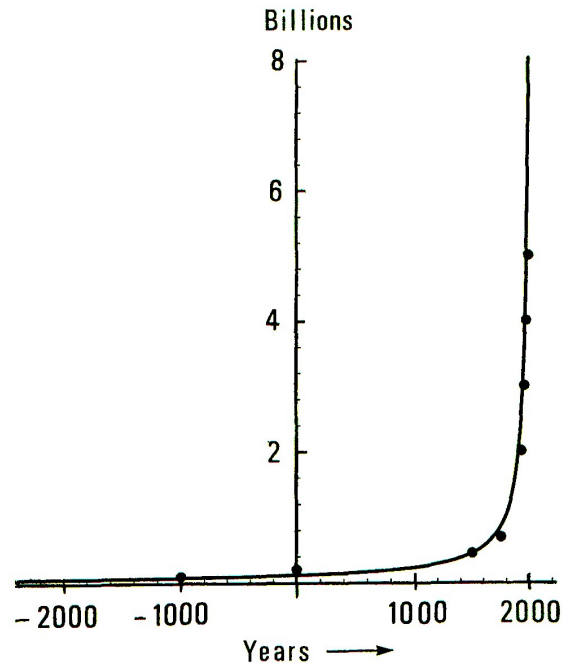

Figure 4.17: Starting with the neolithic agricultural revolution and the invention of writing, human culture began to develop with explosive speed. This figure shows the estimated human population as a function of time during the last 4,000 years. The dots are population estimates in billions, while the solid curve is the hyperbola $p = c/(2020 - y)$, where p is the global human population y is the year, and $c = 234000$. The curve reflects an explosively accelerating accumulation of information. Culturally transmitted techniques of agriculture allowed a much greater density of population than was possible for hunter-gatherers. The growth of population was further accelerated by the invention of printing and by the industrial and scientific developments which followed from this invention.

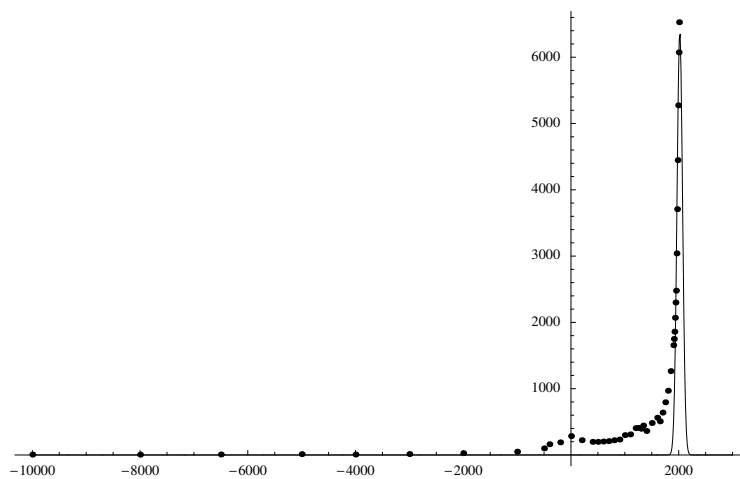

Figure 4.18: Population growth and fossil fuel use, seen on a time-scale of several thousand years. The dots are population estimates in millions from the US Census Bureau. Fossil fuel use appears as a spike-like curve, rising from almost nothing to a high value, and then falling again to almost nothing in the space of a few centuries. When the two curves are plotted together, the explosive rise of global population is seen to be simultaneous with, and perhaps partially driven by, the rise of fossil fuel use. This raises the question of whether the world's population is headed for a crash when the fossil fuel era has ended. (Author's own graph)

In 1848 (when there were just over one billion people in the world), John Stuart Mill described the optimal global population in the following words:

“The density of population necessary to enable mankind to obtain, in the greatest degree, all the advantages of cooperation and social intercourse, has, in the most populous countries, been attained. A population may be too crowded, although all be amply supplied with food and raiment.”

“... Nor is there much satisfaction in contemplating the world with nothing left to the spontaneous activity of nature; with every rood of land brought into cultivation, which is capable of growing food for human beings; every flowery waste or natural pasture plowed up, all quadrupeds or birds which are not domesticated for man’s use exterminated as his rivals for food, every hedgerow or superfluous tree rooted out, and scarcely a place left where a wild shrub or flower could grow without being eradicated as a weed in the name of improved agriculture. If the earth must lose that great portion of its pleasantness which it owes to things that the unlimited increase of wealth and population would extirpate from it, for the mere purpose of enabling it to support a larger, but not better or happier population, I sincerely hope, for the sake of posterity, that they will be content to be stationary, long before necessity compels them to it.”³

Dennis Meadows, one of the authors of *Limits to Growth*, stated recently (in a private conversation) that the sustainable human population in the distant future may be about 2 billion people.

Has the number of humans in the world already exceeded the earth’s sustainable limits? Will the global population of humans crash catastrophically after having exceeded the carrying capacity of the environment? There is certainly a danger that this will happen - a danger that the 21st century will bring very large scale famines to vulnerable parts of the world, because modern energy-intensive agriculture will be dealt a severe blow by prohibitively high petroleum prices, and because climate change will reduce the world’s agricultural output. When the major glaciers in the Himalayas have melted, they will no longer be able to give India and China summer water supplies; rising oceans will drown much agricultural land; and aridity will reduce the output of many regions that now produce much of the world’s grain. Falling water tables in overdrawn aquifers, and loss of topsoil will add to the problem. We should be aware of the threat of a serious global food crisis in the 21st century if we are to have a chance of avoiding it.

The term *ecological footprint* was introduced by William Rees and Mathis Wackernagel in the early 1990’s to compare demands on the environment with the earth’s capacity to regenerate. In 2005, humanity used environmental resources at such a rate that it would take 1.3 earths to renew them. In other words, we have already exceeded the earth’s carrying capacity. Since eliminating the poverty that characterizes much of the world today will require more resources per capita, rather than less. it seems likely that in the era beyond fossil fuels, the optimum global population will be considerably less than the present population of the world.

³John Stuart Mill, *Principles of Political Economy, With Some of Their Applications to Social Philosophy*, (1848).

4.7 Population growth and the Green Revolution

Limitations on cropland

In 1944 the Norwegian-American plant geneticist Norman Borlaug was sent to Mexico by the Rockefeller Foundation to try to produce new wheat varieties that might increase Mexico's agricultural output. Borlaug's dedicated work on this project was spectacularly successful. He remained with the project for 16 years, and his group made 6,000 individual crossings of wheat varieties to produce high-yield disease-resistant strains.

In 1963, Borlaug visited India, bringing with him 100 kg. of seeds from each of his most promising wheat strains. After testing these strains in Asia, he imported 450 tons of the Lerma Rojo and Sonora 64 varieties - 250 tons for Pakistan and 200 for India. By 1968, the success of these varieties was so great that school buildings had to be commandeered to store the output. Borlaug's work began to be called a "Green Revolution". In India, the research on high-yield crops was continued and expanded by Prof. M.S. Swaminathan and his coworkers. The work of Green Revolution scientists, such Norman Borlaug and M.S. Swaminathan, has been credited with saving the lives of as many as a billion people.

Despite these successes, Borlaug believes that the problem of population growth is still a serious one. "Africa and the former Soviet republics", Borlaug states, "and the Cerrado⁴, are the last frontiers. After they are in use, the world will have no additional sizable blocks of arable land left to put into production, unless you are willing to level whole forests, which you should not do. So, future food-production increases will have to come from higher yields. And though I have no doubt that yields will keep going up, whether they can go up enough to feed the population monster is another matter. Unless progress with agricultural yields remains very strong, the next century will experience human misery that, on a sheer numerical scale, will exceed the worst of everything that has come before."

With regard to the prospect of increasing the area of cropland, a report by the United Nations Food and Agricultural Organization (*Provisional Indicative World Plan for Agricultural Development*, FAO, Rome, 1970) states that "In Southern Asia,... in some countries of Eastern Asia, in the Near East and North Africa... there is almost no scope for expanding agricultural area... In the drier regions, it will even be necessary to return to permanent pasture the land that is marginal and submarginal for cultivation. In most of Latin America and Africa south of the Sahara, there are still considerable possibilities for expanding cultivated areas; but the costs of development are high, and it will often be more economical to intensify the utilization of areas already settled." Thus there is a possibility of increasing the area of cropland in Africa south of the Sahara and in Latin America, but only at the cost of heavy investment and at the additional cost of destruction of tropical rain forests.

Rather than an increase in the global area of cropland, we may encounter a future loss of cropland through soil erosion, salination, desertification, loss of topsoil, depletion

⁴ The Cerrado is a large savanna region of Brazil.



Figure 4.19: **Professor M.S. Swaminathan, father of the Green Revolution in India.** (Open and Shut7)



Figure 4.20: **Norman Borlaug and agronomist George Herrer in 1943.** (Human Wrongs Watch)

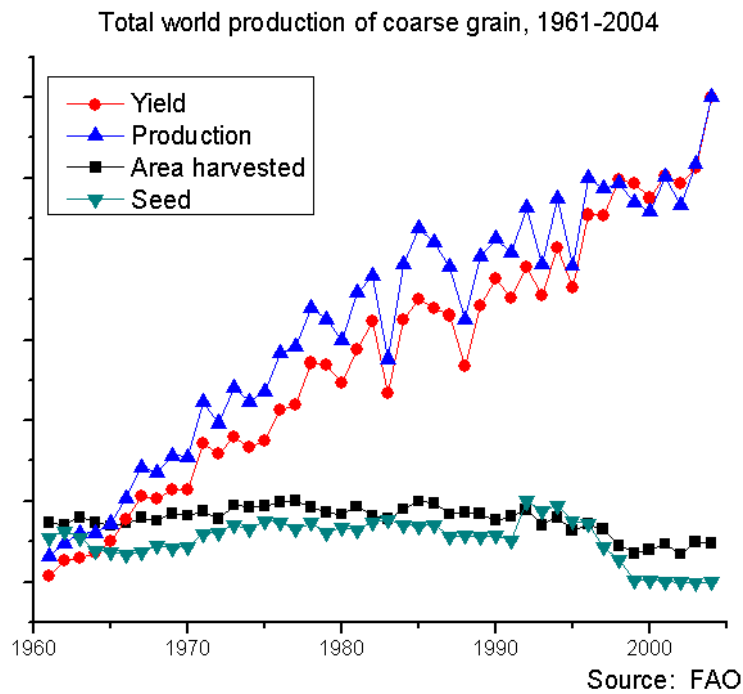

Figure 4.21: This graph shows the total world production of coarse grain between 1960 and 2004. Because of high-yield varieties, the yield of grain increased greatly. Notice, however, that the land under cultivation remained almost constant. High-yield agriculture depends on large inputs of fossil fuel energy and irrigation, and may be difficult to maintain in the future. (FAO)

of minerals in topsoil, urbanization and failure of water supplies. In China and in the southwestern part of the United States, water tables are falling at an alarming rate. The Ogallala aquifer (which supplies water to many of the plains states in the central and southern parts of the United States) has a yearly overdraft of 160%.

In the 1950's, both the U.S.S.R and Turkey attempted to convert arid grasslands into wheat farms. In both cases, the attempts were defeated by drought and wind erosion, just as the wheat farms of Oklahoma were overcome by drought and dust in the 1930's.

If irrigation of arid lands is not performed with care, salt may be deposited, so that the land is ruined for agriculture. This type of desertification can be seen, for example, in some parts of Pakistan. Another type of desertification can be seen in the Sahel region of Africa, south of the Sahara. Rapid population growth in the Sahel has led to overgrazing, destruction of trees, and wind erosion, so that the land has become unable to support even its original population.

Especially worrying is a prediction of the International Panel on Climate Change concerning the effect of global warming on the availability of water: According to Model A1 of the IPCC, global warming may, by the 2050's, have reduced by as much as 30% the water available in large areas of world that now are large producers of grain.

Added to the agricultural and environmental problems, are problems of finance and distribution. Famines can occur even when grain is available somewhere in the world, because those who are threatened with starvation may not be able to pay for the grain, or for its transportation. The economic laws of supply and demand are not able to solve this type of problem. One says that there is no "demand" for the food (meaning demand in the economic sense), even though people are in fact starving.

Suggestions for further reading

1. P. Dasgupta, *Population, Resources and Poverty*, *Ambio*, **21**, 95-101, (1992).
2. L.R. Brown, *Who Will Feed China?*, W.W. Norton, New York, (1995).
3. L.R. Brown, et al., *Saving the Planet. How to Shape and Environmentally Sustainable Global Economy*, W.W. Norton, New York, (1991).
4. L.R. Brown, *Postmodern Malthus: Are There Too Many of Us to Survive?*, *The Washington Post*, July 18, (1993).
5. L.R. Brown and H. Kane, *Full House. Reassessing the Earth's Population Carrying Capacity*, W.W. Norton, New York, (1991).
6. L.R. Brown, *Seeds of Change*, Praeger Publishers, New York, (1970).
7. L.R. Brown, *The Worldwide Loss of Cropland*, Worldwatch Paper 24, Worldwatch Institute, Washington, D.C., (1978).
8. L.R. Brown, and J.L. Jacobson, *Our Demographically Divided World*, Worldwatch Paper 74, Worldwatch Institute, Washington D.C., (1986).
9. L.R. Brown, and J.L. Jacobson, *The Future of Urbanization: Facing the Ecological and Economic Constraints*, Worldwatch Paper 77, Worldwatch Institute, Washington D.C., (1987).

10. L.R. Brown, and others, *State of the World*, W.W. Norton, New York, (published annually).
11. H. Brown, *The Human Future Revisited. The World Predicament and Possible Solutions*, W.W. Norton, New York, (1978).
12. H. Hanson, N.E. Borlaug and N.E. Anderson, *Wheat in the Third World*, Westview Press, Boulder, Colorado, (1982).
13. A. Dil, ed., *Norman Borlaug and World Hunger*, Bookservice International, San Diego/Islamabad/Lahore, (1997).
14. N.E. Borlaug, *The Green Revolution Revisited and the Road Ahead*, Norwegian Nobel Institute, Oslo, Norway, (2000).
15. N.E. Borlaug, *Ending World Hunger. The Promise of Biotechnology and the Threat of Antiscience Zealotry*, *Plant Physiology*, **124**, 487-490, (2000).
16. M. Giampietro and D. Pimental, *The Tightening Conflict: Population, Energy Use and the Ecology of Agriculture*, in *Negative Population Forum*, L. Grant ed., Negative Population Growth, Inc., Teaneck, N.J., (1993).
17. H.W. Kendall and D. Pimental, *Constraints on the Expansion of the Global Food Supply*, *Ambio*, **23**, 198-2005, (1994).
18. D. Pimental et al., *Natural Resources and Optimum Human Population*, *Population and Environment*, **15**, 347-369, (1994).
19. D. Pimental et al., *Environmental and Economic Costs of Soil Erosion and Conservation Benefits*, *Science*, **267**, 1117-1123, (1995).
20. D. Pimental et al., *Natural Resources and Optimum Human Population*, *Population and Environment*, **15**, 347-369, (1994).
21. D. Pimental and M. Pimental, *Food Energy and Society*, University Press of Colorado, Niwot, Colorado, (1996).
22. D. Pimental et al., *Environmental and Economic Costs of Soil Erosion and Conservation Benefits*, *Science*, **267**, 1117-1123, (1995).
23. RS and NAS, *The Royal Society and the National Academy of Sciences on Population Growth and Sustainability*, *Population and Development Review*, **18**, 375-378, (1992).
24. A.M. Altieri, *Agroecology: The Science of Sustainable Agriculture*, Westview Press, Boulder, Colorado, (1995).
25. G. Conway, *The Doubly Green Revolution*, Cornell University Press, (1997).
26. J. Dreze and A. Sen, *Hunger and Public Action*, Oxford University Press, (1991).
27. G. Bridger, and M. de Soissons, *Famine in Retreat?*, Dent, London, (1970).
28. W. Brandt, *World Armament and World Hunger: A Call for Action*, Victor Gollanz Ltd., London, (1982).
29. A.K.M.A. Chowdhury and L.C. Chen, *The Dynamics of Contemporary Famine*, Ford Foundation, Dacca, Pakistan, (1977)
30. J. Shepard, *The Politics of Starvation*, Carnegie Endowment for International Peace, Washington D.C., (1975).
31. M.E. Clark, *Ariadne's Thread: The Search for New Modes of Thinking*, St. Martin's Press, New York, (1989).
32. J.-C. Chesnais, *The Demographic Transition*, Oxford, (1992).

33. C.M. Cipola, *The Economic History of World Population*, Penguin Books Ltd., (1974).
34. E. Draper, *Birth Control in the Modern World*, Penguin Books, Ltd., (1972).
35. Draper Fund Report No. 15, *Towards Smaller Families: The Crucial Role of the Private Sector*, Population Crisis Committee, 1120 Nineteenth Street, N.W., Washington D.C. 20036, (1986).
36. E. Eckholm, *Losing Ground: Environmental Stress and World Food Prospects*, W.W. Norton, New York, (1975).
37. E. Havemann, *Birth Control*, Time-Life Books, (1967).
38. J. Jacobsen, *Promoting Population Stabilization: Incentives for Small Families*, Worldwatch Paper 54, Worldwatch Institute, Washington D.C., (1983).
39. N. Keyfitz, *Applied Mathematical Demography*, Wiley, New York, (1977).
40. W. Latz (ed.), *Future Demographic Trends*, Academic Press, New York, (1979).
41. World Bank, *Poverty and Hunger: Issues and Options for Food Security in Developing Countries*, Washington D.C., (1986).
42. J.E. Cohen, *How Many People Can the Earth Support?*, W.W. Norton, New York, (1995).
43. J. Amos, *Climate Food Crisis to Deepen*, BBC News (5 September, 2005).
44. J. Vidal and T. Ratford, *One in Six Countries Facing Food Shortage*, The Guardian, (30 June, 2005).
45. J. Mann, *Biting the Environment that Feeds Us*, The Washington Post, July 29, 1994.
46. G.R. Lucas, Jr., and T.W. Ogletree, (editors), *Lifeboat Ethics. The Moral Dilemmas of World Hunger*, Harper and Row, New York.
47. J.L. Jacobson, *Gender Bias: Roadblock to Sustainable Development*, Worldwatch Paper 110, Worldwatch Institute, Washington D.C., (1992).
48. J. Gever, R. Kaufmann, D. Skole and C. Vorosmarty, *Beyond Oil: The Threat to Food and Fuel in the Coming Decades*, Ballinger, Cambridge MA, (1986).
49. M. ul Haq, *The Poverty Curtain: Choices for the Third World*, Columbia University Press, New York, (1976).
50. H. Le Bras, *La Planète au Village*, Datar, Paris, (1993).
51. E. Mayr, *Population, Species and Evolution*, Harvard University Press, Cambridge, (1970).
52. Food and Agriculture Organization (FAO), *The Global Forest Assessment 2000* (Rome: Food and Agriculture Organization, Committee on Forestry, 2000).
53. Thomas K. Rudel, Kevin Flesher, Diana Bates, Sandra Baptista, and Peter Holmgren, *Tropical Deforestation Literature: Geographical and Historical Patterns*, *Unasylva* **203**, Vol. 51 (2000): 11-18;
54. Alexander S. Pfaff, *What drives deforestation in the Brazilian Amazon?* *Journal of Economics and Management* **37** (1999): 26-43.
55. Phillip M. Fearnside, *Human Carrying Capacity Estimation in Brazilian Amazonia as the Basis for Sustainable Development*, *Environmental Conservation* **24** (1997): 271-82;

56. Frederick A.B. Meyerson, *Human Population Density, Deforestation and Protected Areas Management: A Multi-scale Analysis of Central America, Guatemala*,
57. The Maya Biosphere Reserve, *Proceedings of the International Union for the Scientific Study of Population*, XXIV General Population Conference (Salvador, Brazil, 2001).
58. C.H. Wood and David L. Skole, *Linking satellite, census, and survey data to study deforestation in the Brazilian Amazon*, in *People and Pixels*, ed. D. Liverman et al. (Washington, DC: National Academies Press, 1998).
59. Suzi Kerr, Alexander S. Pfaff, and Arturo Sanchez, *Development and Deforestation: Evidence From Costa Rica* (unpublished paper, 2003).
60. Frederick A.B. Meyerson, *Population, Biodiversity and Changing Climate*, *Advances in Applied Biodiversity Science* **4** (2003), Chapter 11 (2003): 83-90
61. Andrew D. Foster and Mark R. Rosenzweig, *Economic Growth and the Rise of Forests*," *The Quarterly Journal of Economics* (May 2003): 601-637.
62. A. Balmford et al., *Conservation Conflicts Across Africa*, *Science* **291** (2001): 2616-19.
63. Richard P. Cincotta, Jennifer Wisniewski, and Robert Engelman, *Human Population in the Biodiversity Hotspots*, *Nature* **404** (2000): 990-92.
64. Food and Agriculture Organization of the United Nations (FAO). 2010. *Global Forest Resources Assessment 2010*. Rome: FAO.
65. World Bank. 2004. *Sustaining Forests: A Development Strategy*. Washington DC: World Bank.
66. Food and Agriculture Organization of the United Nations (FAO). 2006. *Global Forest Resources Assessment 2005: Progress Towards Sustainable Forest Management*. Rome: FAO.
67. United Nations Population Division. 2009. *World Population Prospects: The 2008 Revision*. New York: UN Population Division.
68. Pan, W, D Carr, A Barbierri, R Bilsborrow and C Suchindran. 2007. *Forest Clearing in the Ecuadorian Amazon: A Study of Patterns Over Space and Time*. *Population Research and Policy Review* **26**:635-659.
69. Geist, H J and E F Lambin. 2002. *Proximate Causes and Underlying Driving Forces of Tropical Deforestation*. *Bioscience* **52(2)**: 143-150.
70. Rosero-Bixby, L and A Palloni. 1996. *Population and Deforestation in Costa Rica*. CDE Working Paper No. 96-19. Madison: 1996.
71. Carr, D, L Sutter and A Barbieri. 2006. *Population Dynamics and Tropical Deforestation: State of the Debate and Conceptual Challenges*. *Population and Environment* **27**:89-113.
72. Barreto, P, C Souza, R Nogueron, A Anderson, R Salamao and J Wiles. 2006. *Human Pressure on the Brazilian Amazon Forests*. Washington DC: World Resources Institute (WRI).
73. Ramankutty, N, JA Foley and NJ Olejniczak. 2002. *People on the Land: Changes in Global Population and Croplands during the 20th Century*. *Ambio* **31(3)**: 251-257.

74. Food and Agriculture Organization of the United Nations (FAO). 2008. *Forests and Energy: Key Issues*. Rome: FAO.
75. Millenium Ecosytem Assessment. 2005. *Ecosystems and Human Well-Being Biodiversity Synthesis*. Washington DC: World Resources Institute (WRI).
76. Sherbinin, A, D Carr, S Cassels and L Jiang. 2007. *Population and Environment*. The Annual Review of Environment and Resources **32**: 345-373.
77. Leahy, E, R Englelman, C Vogel, S Haddock and T Preston. 2007. **The Shape of Things to Come**. Washington, DC: PAI.
78. DeFries, R, T K Rudel, M Uriarte and M Hansen. 2010. *Deforestation Driven by Urban Population Growth and Agricultural Trade in the Twenty-First Century*. Nature Geoscience **3**: 178-181.
79. Lambin, E F and P Meyfroidt. 2011. *Global Land Use Change, Economic Globalization, and the Looming Land Scarcity*. Proceedings of the National Academy of Sciences **108**: 3465-3472.
80. United Nations Population Division. 2010. *World Urbanization Prospects: The 2009 Revision*. New York: UN Population Division.
81. Bonan, G. B. (2008). *Forests and climate change: Forcings, feedbacks, and the climate benefits of forests*. Science. **320** (5882): 1444-1449.
82. Scheil, D.; Murdiyarsa, D. (2009). *How Forests Attract Rain: An Examination of a New Hypothesis*. BioScience. **59** (4): 341-347.
83. Ahmad, Y.J. and M. Kassas. 1987. *Desertification: Financial Support for the Biosphere*. West Hartford, Conn.: Kumarian Press.
84. Barrow, C. J. 1991. *Land Degradation - Developments and Breakdown of Terrestrial Environments*. Cambridge: Cambridge University Press.
85. Gadgil, M. 1989. *Deforestation: Problems and prospects*. Foundation Day Lecture, Society for Promotion of Wastelands Development, 12 May, New Delhi. Centre of Ecological Sciences and Theoretical Studies, Indian Institute of Science Bangalore.
86. Government of India. 1987. *State of Forest Report 1987*. Forest Survey of India, Dehradun.
87. Government of India. 1991. *State of Forest Report, 1987-1989*. Forest Survey of India, Dehradun.
88. Kassas, M. 1987. *Drought and desertification*. Land Use Policy **4**(4): 389-400.
89. Kemp, D. D. 1990. *Global Environmental Issues - A Climatological Approach*. London: Routledge.
90. Maheshwari, J. K. 1989. *Processing and Utilization of Perennial Vegetation in the Arid Zone of India* in **Role of Forestry in Combatting Desertification**. Rome: FAO Conservation Guide 21, pp. 137-172.
91. Reining, P. 1978. *Handbook on Desertification Indicators*. Washington, D.C.: American Association for the Advancement of Science.
92. Tolba, M. K. 1987. *Sustainable Development: Constraints and Opportunities* London: Butterworth.
93. Tolba, M. K., O. A. El-Kholy, et al. 1992. *The World Environment 1972-1992. Two Decades of Challenge*. London: Chapman and Hall.

94. Tucker, C. J., H. E. Dregne, and W. W. Newcomb. 1991. *Expansion and contraction of Sahara Desert from 1980-1990*. *Science* **253**.
95. UNCED (United Nations Conference on Environment and Development). 1992. *Agenda 21*. United Nations Conference on Environment and Development, Brazil, June 3-14,1992. Brazil: UNCED.
96. UNEP (United Nations Environment Programme). 1984. *General Assessment of Progress in the Implementation of the Plan of Action to Combat Desertification, 1978-1984*. GC-12/9.
97. UNEP (United Nations Environment Programme). 1991. *Status of Desertification and Implementation of the United Nations Plan of Action to Control Desertification*. Nairobi: UNEP.
98. Wimpenny, J. T. (ed.). 1990. *Development Research: The Environmental Challenge*. Boulder, Colo.: Westview Press, for the ODI.
99. Wood, W. B. 1990. *Tropical Deforestation. Balancing Regional Development Demands and Global Environmental Concerns*.
100. World Bank. 1989. *World Development Report 1989*. Oxford: Oxford University Press.
101. World Bank. 1992. *World Development Report 1992*. Oxford: Oxford University Press.

Chapter 5

WRITING. PAPER AND PRINTING

5.1 Mesopotamia

In Mesopotamia (which in Greek means “between the rivers”), the settled agricultural people of the Tigris and Euphrates valleys evolved a form of writing. Among the earliest Mesopotamian writings are a set of clay tablets found at Tepe Yahya in southern Iran, the site of an ancient Elamite trading community halfway between Mesopotamia and India.

The Elamite trade supplied the Sumerian civilization of Mesopotamia with silver, copper, tin, lead, precious gems, horses, timber, obsidian, alabaster and soapstone. The practical Sumerians and Elamites probably invented writing as a means of keeping accounts.

The tablets found at Tepe Yahya are inscribed in proto-Elamite, and radio-carbon dating of organic remains associated with the tablets shows them to be from about 3,600 B.C.. The inscriptions on these tablets were made by pressing the blunt and sharp ends of a stylus into soft clay. Similar tablets have been found at the Sumerian city of Susa at the head of the Tigris River.

In about 3,100 B.C. the cuneiform script was developed, and later Mesopotamian tablets are written in cuneiform, which is a phonetic script where the symbols stand for syllables.



Figure 5.1: Sumerian writing

5.2 Egypt

The Egyptian hieroglyphic (priest writing) system began its development in about 4,000 B.C.. At that time, it was pictorial rather than phonetic. However, the Egyptians were in contact with the Sumerian civilization of Mesopotamia, and when the Sumerians developed a phonetic system of writing in about 3,100 B.C., the Egyptians were quick to adopt the idea. In the cuneiform writing of the Sumerians, a character stood for a syllable. In the Egyptian adaptation of this idea, most of the symbols stood for combinations of two consonants, and there were no symbols for vowels. However, a few symbols were purely alphabetic, i.e. they stood for sounds which we would now represent by a single letter. This was important from the standpoint of cultural history, since it suggested to the Phoenicians the idea of an alphabet of the modern type.

In Sumer, the pictorial quality of the symbols was lost at a very early stage, so that in the cuneiform script the symbols are completely abstract. By contrast, the Egyptian system of writing was designed to decorate monuments and to be impressive even to an illiterate viewer; and this purpose was best served by retaining the elaborate pictographic form of the symbols.



Figure 5.2: The Phoenician alphabet



Figure 5.3: Hieroglyphics

5.3 China

Writing was developed at a very early stage in Chinese history, but the system remained a pictographic system, with a different character for each word. A phonetic system of writing was never developed.

The failure to develop a phonetic system of writing had its roots in the Chinese imperial system of government. The Chinese empire formed a vast area in which many different languages were spoken. It was necessary to have a universal language of some kind in order to govern such an empire. The Chinese written language solved this problem admirably.

Suppose that the emperor sent identical letters to two officials in different districts. Reading the letters aloud, the officials might use entirely different words, although the characters in the letters were the same. Thus the Chinese written language was a sort of “Esperanto” which allowed communication between various language groups, and its usefulness as such prevented its replacement by a phonetic system.

The disadvantages of the Chinese system of writing were twofold: First, it was difficult to learn to read and write; and therefore literacy was confined to a small social class whose members could afford a prolonged education. The system of civil-service examinations made participation in the government dependant on a high degree of literacy; and hence the old, established scholar-gentry families maintained a long-term monopoly on power, wealth and education. Social mobility was possible in theory, since the civil service examinations were open to all, but in practice, it was nearly unattainable.

The second great disadvantage of the Chinese system of writing was that it was unsuitable for printing with movable type. An “information explosion” occurred in the west following the introduction of printing with movable type, but this never occurred in China. It is ironical that although both paper and printing were invented by the Chinese, the full effect of these immensely important inventions bypassed China and instead revolutionized the west.



Figure 5.4: Very early Chinese writing on a bone



Figure 5.5: Chinese writing in a later form

5.4 The Americas

The Mayan system of writing is thought to have been invented in about 700 B.C., and this invention is believed to be entirely independent of the invention of writing elsewhere. Some of the Mayan glyphs represented entire words, but they could also represent syllables.

Knotted string systems of keeping records were used by the Andean peoples of South America, especially by the Inca civilization. In the Incan language collections of knotted strings were known as *quipus* or talking knots. Quipus could have only a few, or as many as 2000 knotted strings.

Belts made from shell beads (*wampum*) were used by the native peoples of North America, both as currency and as a means of recording events.



Figure 5.6: Mayan writing.

5.5 The invention of paper

The ancient Egyptians were the first to make books. As early as 4,000 B.C., they began to make books in the form of scrolls by cutting papyrus reeds into thin strips and pasting them into sheets of double thickness. The sheets were glued together end to end, so that they formed a long roll. The rolls were sometimes very long indeed. For example, one roll, which is now in the British Museum, is 17 inches wide and 135 feet long.

(Paper of the type which we use today was not invented until 105 A.D.. This enormously important invention was made by a Chinese eunuch named Tsai Lun. The kind of paper invented by Tsai Lun could be made from many things: for example, bark, wood, hemp, rags, etc.. The starting material was made into a pulp, mixed together with water and binder, spread out on a cloth to partially dry, and finally heated and pressed into thin sheets. The art of paper-making spread slowly westward from China, reaching Baghdad in 800 A.D.. It was brought to Europe by the crusaders returning from the Middle East. Thus paper reached Europe just in time to join with Gutenberg's printing press to form the basis for the information explosion which has had such a decisive effect on human history.)

Many centers of paper production were established throughout the Muslim world, and their techniques were eventually transmitted to Christian Europe. Not only was paper convenient to use, transport, and store, it was, most importantly, considerably cheaper than papyrus and parchment, probably partly because of the use of recycled rags as raw material in its manufacture. Whereas an early Qur'an copy on parchment is reckoned to have required the skins of about 300 sheep, an equivalent amount of paper could be produced much more rapidly, in much greater quantities, and at much lower cost. This transformed the economics of book production, and made possible a greatly increased production of manuscript books, on a scale which was unprecedented and unmatched in Europe at that time.

The career of Leonardo da Vinci illustrates the first phase of the "information explosion" which has produced the modern world: During Leonardo's lifetime, inexpensive paper was being manufactured in Europe, and it formed the medium for Leonardo's thousands of pages of notes. His notes and sketches would never have been possible if he had been forced to use expensive parchment as a medium. On the other hand, the full force of Leonardo's genius and diligence was never felt because his notes were not printed.

Copernicus, who was a younger contemporary of Leonardo, had a much greater effect on the history of ideas, because his work was published. Thus, while paper alone made a large contribution to the information explosion, it was printing combined with paper which had an absolutely decisive and revolutionary impact: The modern scientific era began with the introduction of printing.



Figure 5.7: Papyrus



Figure 5.8: Paper is a Chinese invention



Figure 5.9: Italian paper-mill, probably from the 16th century.



Figure 5.10: The impact of Leonardo da Vinci's genius would have been far greater if his thousands of pages of notes had been printed.

5.6 Printing

It was during the T'ang period that the Chinese made an invention of immense importance to the cultural evolution of mankind. This was the invention of printing. Together with writing, printing is one of the key inventions which form the basis of human cultural evolution.

Printing was invented in China in the 8th or 9th century A.D., probably by Buddhist monks who were interested in producing many copies of the sacred texts which they had translated from Sanskrit. The act of reproducing prayers was also considered to be meritorious by the Buddhists.

The Chinese had for a long time followed the custom of brushing engraved official seals with ink and using them to stamp documents. The type of ink which they used was made from lamp-black, water and binder. In fact, it was what we now call "India ink". However, in spite of its name, India ink is a Chinese invention, which later spread to India, and from there to Europe.

We mentioned that paper of the type which we now use was invented in China in the first century A.D.. Thus, the Buddhist monks of China had all the elements which they needed to make printing practical: They had good ink, cheap, smooth paper, and the tradition of stamping documents with ink-covered engraved seals. The first block prints which they produced date from the 8th century A.D.. They were made by carving a block of wood the size of a printed page so that raised characters remained, brushing ink onto the block, and pressing this onto a sheet of paper.

The oldest known printed book, the "Diamond Sutra", is dated 868 A.D., and it consists of only six printed pages. It was discovered in 1907 by an English scholar who obtained permission from Buddhist monks in Chinese Turkestan to open some walled-up monastery rooms, which were said to have been sealed for 900 years. The rooms were found to contain a library of about 15,000 manuscripts, among which was the Diamond Sutra.

Block printing spread quickly throughout China, and also reached Japan, where wood-block printing ultimately reached great heights in the work of such artists as Hiroshige and Hokusai. The Chinese made some early experiments with movable type, but movable type never became popular in China, because the Chinese written language contains 10,000 characters. However, printing with movable type was highly successful in Korea as early as the 15th century A.D..

The unsuitability of the Chinese written language for the use of movable type was the greatest tragedy of the Chinese civilization. Writing had been developed at a very early stage in Chinese history, but the system remained a pictographic system, with a different character for each word. A phonetic system of writing was never developed.

The failure to develop a phonetic system of writing had its roots in the Chinese imperial system of government. The Chinese empire formed a vast area in which many different languages were spoken. It was necessary to have a universal language of some kind in order to govern such an empire. The Chinese written language solved this problem admirably.

Suppose that the emperor sent identical letters to two officials in different districts.



Figure 5.11: **The Diamond Sutra, 868 A.D., is the first known printed book.**

Reading the letters aloud, the officials might use entirely different words, although the characters in the letters were the same. Thus the Chinese written language was a sort of “Esperanto” which allowed communication between various language groups, and its usefulness as such prevented its replacement by a phonetic system.

The invention of block printing during the T’ang dynasty had an enormously stimulating effect on literature, and the T’ang period is regarded as the golden age of Chinese lyric poetry. A collection of T’ang poetry, compiled in the 18th century, contains 48,900 poems by more than 2,000 poets.

5.7 Islamic civilization and printing

Muslims in Egypt and probably elsewhere were using printing to mass-produce texts as early as the 10th century. Dozens of examples of their output are preserved in museums and libraries, but have, until recently, been overlooked and neglected by scholars. This phenomenon is yet another example of the 1000-year missing history of science and technology.

It is, however, true that Muslims did not use printing to produce books, nor extended texts in any form, until the 18th century. This challenge was taken up by Europeans from the 15th century onwards, and it would not have been possible there, without the availability of another gift from the Muslims, paper, which had earlier reached Europe from



Figure 5.12: A handwritten Islamic manuscript: Qazwini, 'Ajaib al-makhlukat, MS probably from Mosul, ca.1305. British Library.

the Muslim world, via Spain and Italy.

5.8 Gutenberg

Johannes Gensfleisch zur Laden zum Gutenberg (c.1400-1468) was born in the German city of Mainz. He was the youngest son of an upper-class merchant, Friele Gensfleisch zur Laden, whose long-established family traced its roots back to the 13th century.

Johannes Gutenberg was educated as a goldsmith and blacksmith, and may also have attended the University of Erfurt. In 1440, while he was living in Strassburg, he is said to have perfected and unveiled his system of printing with movable type.

By 1448, he was back in Mainz, where he took a loan from his brother-in-law to meet the expenses of setting up a printing press. In 1450, the press was in operation, and Gutenberg took a further loan, 800 guilders, from the moneylender Johann Fust. Peter Schöffer, who became Fust's son-in-law also joined the enterprise, and is believed to have designed the type faces.

Among the many technical innovations introduced by Gutenberg are the invention of a process for mass-producing movable type; the use of oil-based ink for printing books; adjustable molds; mechanical movable type; and the use of a wooden printing press similar to the agricultural screw presses of the period. The alloy which he used was a mixture of lead, tin, and antimony that melted at a relatively low temperature for faster and more economical casting, cast well, and created a durable type. The combination of all these elements made the mass production of books both practical and economically feasible.

Gutenberg's greatest artistic achievement was his printed Bible, but this project also cost so much that it left him with debts of more than 20,000 guilders. A court order gave Fust control of the Bible printing project, and half of the printed Bibles.

Although he had suffered bankruptcy, the aging Gutenberg's greatness was acknowledged in 1465. He was given the title "Hofmann" (Gentleman of the Court) and awarded a yearly stipend, as well as 2,180 liters of grain and 2,000 liters of wine tax-free. He died in 1468, having enjoyed this official recognition for only three years.

Printing quickly affected both religion and science in Europe. By 1517, when Martin Luther posted his Ninety-Five Theses on the door of All Saint's Church in Wittenburg, many cities had printing presses. The theses were quickly reprinted and translated, and they spread throughout Europe. This initiated a pamphlet war, in which both sides used printing to spread their views. The impact of Luther's German translation of the Bible was greatly increased by the fact that inexpensive printed copies were widely available.

Science was similarly revolutionized. Nicolaus Copernicus (1473-1543) had a far greater impact on the history of science than his near contemporary Leonardo da Vinci (1452-1519) because of printing. Leonardo's thousands of pages of notes and his innovations in virtually all the fields of human knowledge have only recently become available in printed form. By contrast, the publication Copernicus' great book, *De revolutionibus orbium coelestium* (On the Revolutions of the Celestial Spheres) initiated a sequence of discoveries by Tycho Brahe, Galileo, Johannes Kepler and Isaac Newton, discoveries upon which the modern world is built.



Figure 5.13: Gutenberg is credited with introducing printing with movable type into Europe, with many improvements of technique. His inventions were a turning point in European history, and ushered in the modern era, the Reformation, the Age of Reason and the Industrial Revolution.



Figure 5.14: Gutenberg's printing press



Figure 5.15: Gutenberg's bible

5.9 The Enlightenment

Political philosophy of the Enlightenment

The 16th, 17th and 18th centuries have been called the “Age of Discovery”, and the “Age of Reason”, but they might equally well be called the “Age of Observation”. On every side, new worlds were opening up to the human mind. The great voyages of discovery had revealed new continents, whose peoples demonstrated alternative ways of life. The telescopic exploration of the heavens revealed enormous depths of space, containing myriads of previously unknown stars; and explorations with the microscope revealed a new and marvelously intricate world of the infinitesimally small.

In the science of this period, the emphasis was on careful observation. This same emphasis on observation can be seen in the Dutch and English painters of the period. The great Dutch masters, such as Jan Vermeer (1632-1675), Frans Hals (1580-1666), Pieter de Hooch (1629-1678) and Rembrandt van Rijn (1606-1669), achieved a careful realism in their paintings and drawings which was the artistic counterpart of the observations of the pioneers of microscopy, Anton van Leeuwenhoek and Robert Hooke. These artists were supported by the patronage of the middle class, which had become prominent and powerful both in England and in the Netherlands because of the extensive world trade in which these two nations were engaged.

Members of the commercial middle class needed a clear and realistic view of the world in order to succeed with their enterprises. (An aristocrat of the period, on the other hand, might have been more comfortable with a somewhat romanticized and out-of-focus vision, which would allow him to overlook the suffering and injustice upon which his privileges were based.) The rise of the commercial middle class, with its virtues of industriousness, common sense and realism, went hand in hand with the rise of experimental science, which required the same virtues for its success.

In England, the House of Commons (which reflected the interests of the middle class), had achieved political power, and had demonstrated (in the Puritan Rebellion of 1640 and the Glorious Revolution of 1688) that Parliament could execute or depose any monarch who tried to rule without its consent. In France, however, the situation was very different.

After passing through a period of disorder and civil war, the French tried to achieve order and stability by making their monarchy more absolute. The movement towards absolute monarchy in France culminated in the long reign of Louis XIV, who became king in 1643 and who ruled until he died in 1715.

The historical scene which we have just sketched was the background against which the news of Newton’s scientific triumph was received. The news was received by a Europe which was tired of religious wars; and in France, it was received by a middle class which was searching for an ideology in its struggle against the *ancien régime*.

To the intellectuals of the 18th century, the orderly Newtonian cosmos, with its planets circling the sun in obedience to natural law, became an imaginative symbol representing rationality. In their search for a society more in accordance with human nature, 18th

century Europeans were greatly encouraged by the triumphs of science. Reason had shown itself to be an adequate guide in natural philosophy. Could not reason and natural law also be made the basis of moral and political philosophy? In attempting to carry out this program, the philosophers of the Enlightenment laid the foundations of psychology, anthropology, social science, political science and economics.

One of the earliest and most influential of these philosophers was John Locke (1632-1705), a contemporary and friend of Newton. In his *Second Treatise on Government*, published in 1690, John Locke's aim was to refute the doctrine that kings rule by divine right, and to replace that doctrine by an alternative theory of government, derived by reason from the laws of nature. According to Locke's theory, men originally lived together without formal government:

"Men living together according to reason," he wrote, "without a common superior on earth with authority to judge between them, is properly the state of nature... A state also of equality, wherein all the power and jurisdiction is reciprocal, no one having more than another; there being nothing more evident than that creatures of the same species, promiscuously born to all the same advantages of nature and the use of the same facilities, should also be equal amongst one another without subordination or subjection..."

"But though this be a state of liberty, yet it is not a state of licence... The state of nature has a law to govern it, which obliges every one; and reason, which is that law, teaches all mankind who will but consult it, that being equal and independent, no one ought to harm another in his life, health, liberty or possessions."

In Locke's view, a government is set up by means of a social contract. The government is given its powers by the consent of the citizens in return for the services which it renders to them, such as the protection of their lives and property. If a government fails to render these services, or if it becomes tyrannical, then the contract has been broken, and the citizens must set up a new government.

Locke's influence on 18th century thought was very great. His influence can be seen, for example, in the wording of the American Declaration of Independence. In England, Locke's political philosophy was accepted by almost everyone. In fact, he was only codifying ideas which were already in wide circulation and justifying a revolution which had already occurred. In France, on the other hand, Locke's writings had a revolutionary impact.

Credit for bringing the ideas of both Newton and Locke to France, and making them fashionable, belongs to Francois Marie Arouet (1694-1778), better known as "Voltaire". Besides persuading his mistress, Madame de Chatelet, to translate Newton's *Principia* into French, Voltaire wrote an extremely readable commentary on the book; and as a result, Newton's ideas became highly fashionable among French intellectuals. Voltaire lived with Madame du Chatelet until she died, producing the books which established him as the leading writer of Europe, a prophet of the Age of Reason, and an enemy of injustice, feudalism and superstition.

The Enlightenment in France is considered to have begun with Voltaire's return from England in 1729; and it reached its high point with the publication of the *Encyclopedia* between 1751 and 1780. Many authors contributed to the *Encyclopedia*, which was an enormous work, designed to sum up the state of human knowledge.

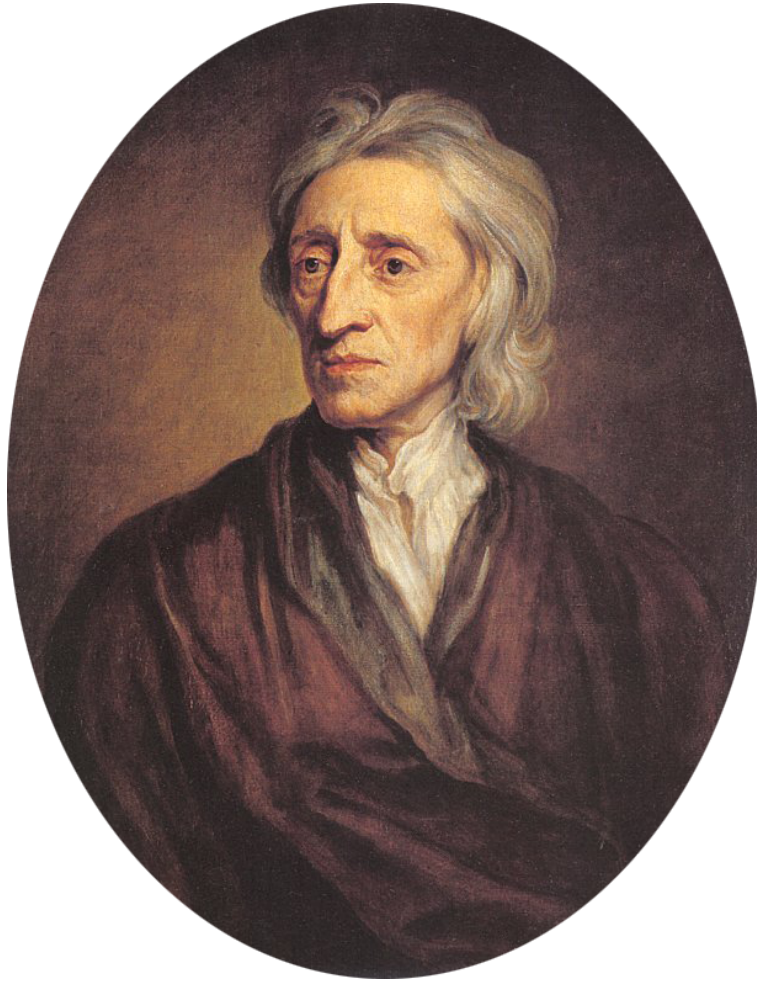

Figure 5.16: John Locke (1632-1705): “Men living together according to reason, without a common superior on earth with authority to judge between them, is properly the state of nature... A state also of equality, wherein all the power and jurisdiction is reciprocal, no one having more than another; there being nothing more evident than that creatures of the same species, promiscuously born to all the same advantages of nature and the use of the same facilities, should also be equal amongst one another without subordination or subjugation...”

Turgot and Montesquieu wrote on politics and history; Rousseau wrote on music, and Buffon on natural history; Quesnay contributed articles on agriculture, while the Baron d'Holbach discussed chemistry. Other articles were contributed by Condorcet, Voltaire and d'Alembert. The whole enterprise was directed and inspired by the passionate faith of Denis Diderot (1713-1784). The men who took part in this movement called themselves "*philosophes*". Their creed was a faith in reason, and an optimistic belief in the perfectibility of human nature and society by means of education, political reforms, and the scientific method.

The *philosophes* of the Enlightenment visualized history as a long progression towards the discovery of the scientific method. Once discovered, this method could never be lost; and it would lead inevitably (they believed) to both the material and moral improvement of society. The *philosophes* believed that science, reason, and education, together with the principles of political liberty and equality, would inevitably lead humanity forward to a new era of happiness. These ideas were the faith of the Enlightenment; they influenced the French and American revolutions; and they are still the basis of liberal political belief.

Voltaire and Rousseau

Voltaire (1694-1778)

Francois-Marie Arouet, who later changed his name to Voltaire, was born in Paris. His father was a lawyer and a minor treasury official, while his mother's family was on the lowest rank of the French nobility. He was educated by Jesuits at Collège Louis-le-Grande, where he learned Latin theology and rhetoric. He later became fluent in Italian, Spanish and English.

Despite his father's efforts to make him study law, the young Voltaire was determined to become a writer. He eventually became the author of more than 2,000 books and pamphlets and more than 20,000 letters. His works include many forms of writing, including plays, poems, novels, essays and historical and scientific works. His writings advocated civil liberties, and he used his satirical and witty style of writing to criticize intolerance, religious dogma and absolute monarchy. Because of the intolerance and censorship of his day, he was frequently in trouble and sometimes imprisoned. Nevertheless, his works were very popular, and he eventually became extremely rich, partly through clever investment of money gained through part ownership of a lottery.

During a period of forced exile in England, Voltaire mixed with the English aristocracy, meeting Alexander Pope, John Gay, Jonathan Swift, Lady Mary Wortley Montagu, Sarah, Duchess of Marlborough, and many other members of the nobility and royalty. He admired the English system of constitutional monarchy, which he considered to be far superior to the absolutism then prevailing in France. In 1733, he published a book entitled *Letters concerning the English Nation*, in London. When French translation was published in 1734, Voltaire was again in deep trouble. In order to avoid arrest, he stayed in the country château belonging to Émilie du Châtelet and her husband, the Marquis du Châtelet.

As a result, Madame du Châtelet became his mistress and the relationship lasted for

16 years. Her tolerant husband, the Marquis, who shared their intellectual and scientific interests, often lived together with them. Voltaire paid for improvements to the château, and together, the Marquis and Voltaire collected more than 21,000 books, and enormous number for that time. Madame du Châtelet translated Isaac Newton's great book, *Principia Mathematica*, into French, and her translation was destined to be the standard one until modern times. Meanwhile, Voltaire wrote a French explanation of the ideas of the *Principia*, which made these ideas accessible to a wide public in France. Together, the Marquis, his wife and Voltaire also performed many scientific experiments, for example experiments designed to study the nature of fire.

Voltaire's vast literary output is available today in approximately 200 volumes, published by the University of Oxford, where the Voltaire Foundation is now established as a research department.

Rousseau (1712-1778)

In 1754 Rousseau wrote: "The first man who, having fenced in a piece of land, said 'This is mine', and found people naïve enough to believe him, that man was the true founder of civil society. From how many crimes, wars, and murders, from how many horrors and misfortunes might not any one have saved mankind, by pulling up the stakes, or filling up the ditch, and crying to his fellows: Beware of listening to this impostor; you are undone if you once forget that the fruits of the earth belong to us all, and the earth itself to nobody."

Later, he began his influential book *The Social Contract*, published in 1752, with the dramatic words: "Man is born free, and everywhere he is in chains. Those who think themselves the masters of others are indeed greater slaves than they." Rousseau concludes Chapter 3 of this book with the words: "Let us then admit that force does not create right, and that we are obliged to obey only legitimate powers". In other words, the ability to coerce is not a legitimate power, and there is no rightful duty to submit to it. A state has no right to enslave a conquered people.

These ideas, and those of John Locke, were reaffirmed in 1776 by the American Declaration of Independence: "We hold these truths to be self-evident: That all men are created equal. That they are endowed by their Creator with certain inalienable rights, and that among these are the rights to life, liberty and the pursuit of happiness; and that to pursue these rights, governments are instituted among men, deriving their just powers from the consent of the governed."

Today, in an era of government tyranny and subversion of democracy, we need to remember that the just powers of any government are not derived from the government's ability to use of force, but exclusively from the consent of the governed.



Figure 5.17: Voltaire used his satirical and witty style of writing to criticize intolerance, religious dogma and absolute monarchy. He wrote more than 2,000 books and pamphlets and more than 20,000 letters. His writings made a significant contribution to the Enlightenment, and paved the way for revolutions both in France and America.



Figure 5.18: The frontpiece of Voltaire's book popularizing Newton's ideas for French readers. Madame du Châtelet appears as a muse, reflecting Newton's thoughts down to Voltaire.

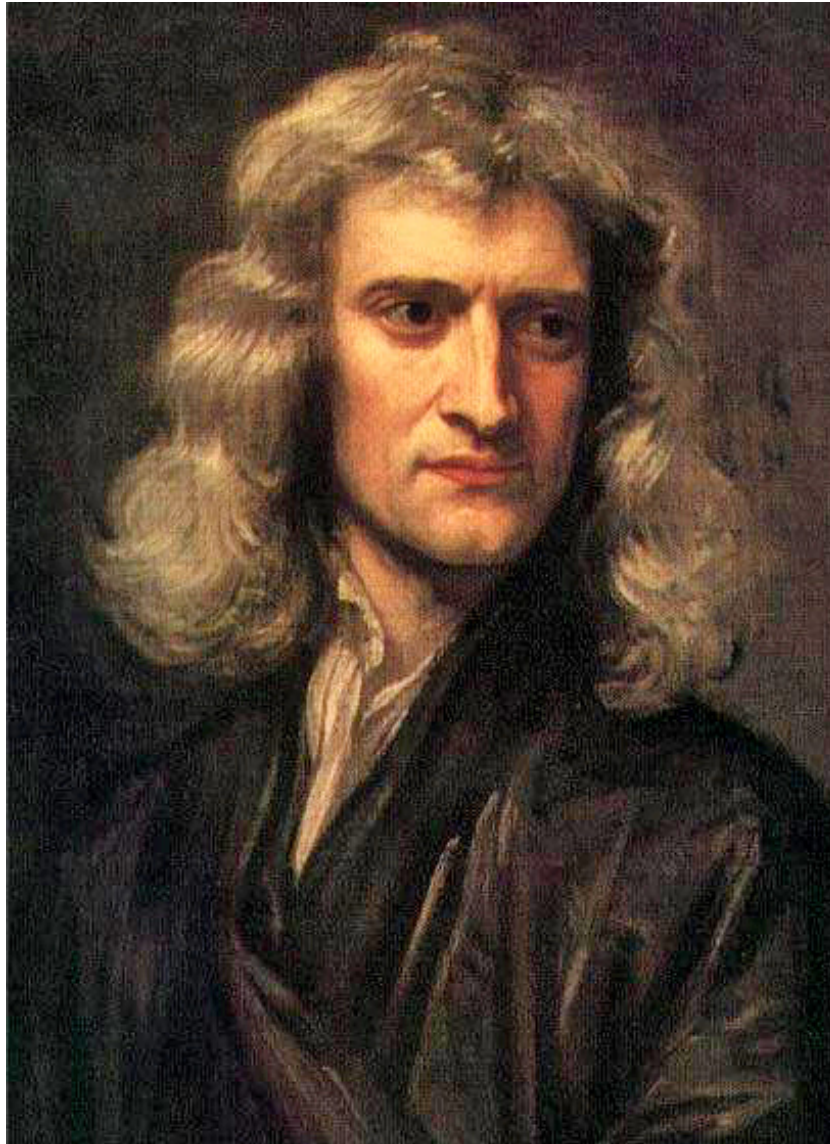

Figure 5.19: The work of Sir Isaac Newton (1642-1726) illustrates a key aspect of human cultural evolution: Because of the introduction of printing in Europe, Newton was able to build on the work of his predecessors, Copernicus, Brahe, Galileo and Kepler. He could never have achieved his great synthesis alone. During the Enlightenment, Newton became a symbol of rationality and reason. Alexander Pope wrote: “Nature, and nature’s laws, lay hid in night. God said ‘Let Newton be’, and all was light!”

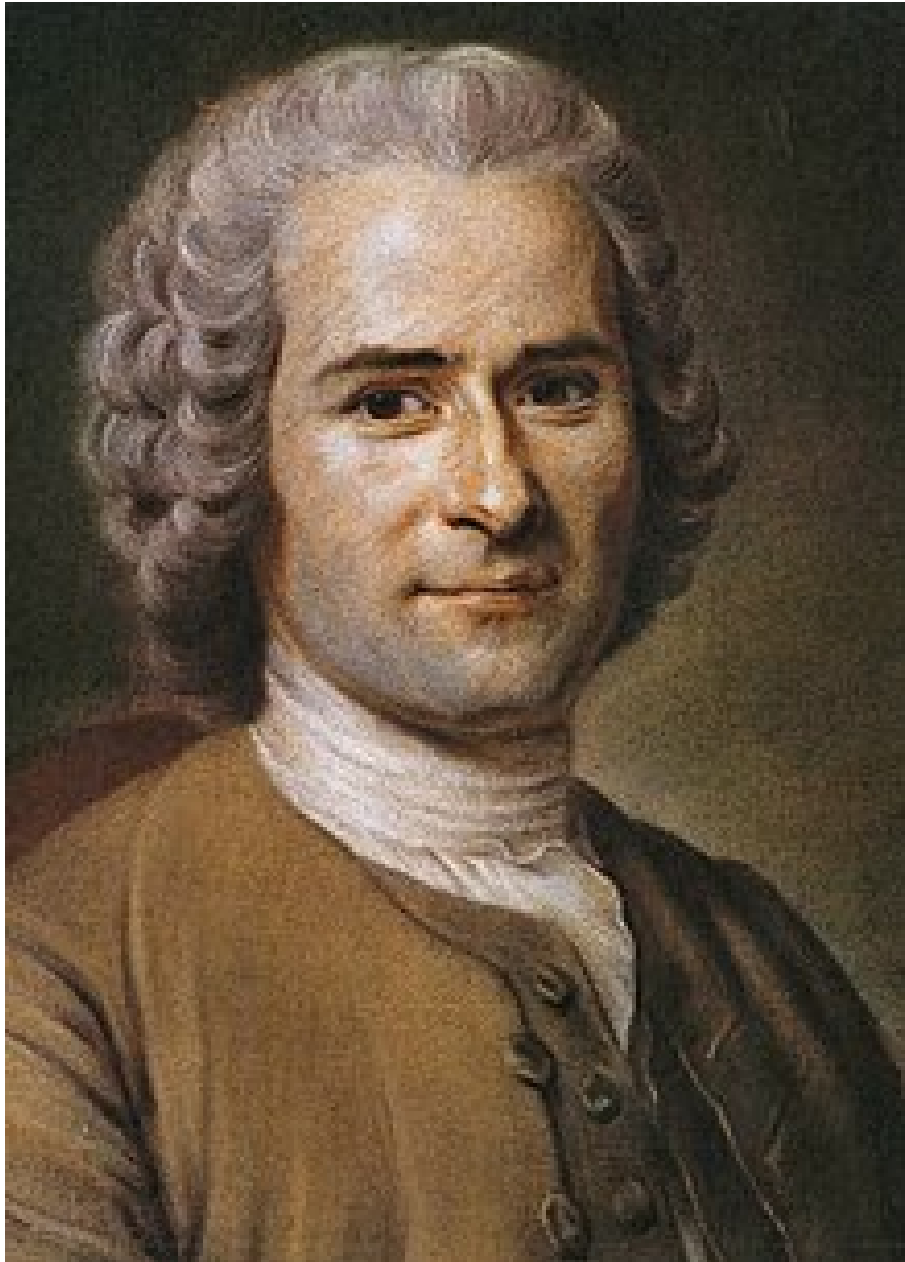

Figure 5.20: Unlike Voltaire, Rousseau was not an advocate of science, but instead believed in the importance of emotions. He believed that civilization has corrupted humans rather than making them better. Rousseau was a pioneer of the romantic movement. His book, *The Social Contract*, remains influential today.



Figure 5.21: The printer and publisher Joseph Johnson (1738-1809).

The printer and publisher Joseph Johnson

As an example of the influence of printing on the liberation of ideas, we can consider the circle of important authors that formed around the English printer and publisher Joseph Johnson (1738-1809). His weekly dinners for authors were famous. Among the many great thinkers, artists, scientists, writers and religious dissenters who attended these dinners, or whose works he published, were William Cowper, Erasmus Darwin, William Blake, Henry Fuselli, Mary Wollstonecraft, William Godwin, Thomas Robert Malthus, Thomas Paine, Pricilla Wakefield, Gilbert Wakefield, Benjamin Franklin, Richard Price and Joseph Priestley.

Throughout her career, the pioneering feminist writer Mary Wollstonecraft was aided by Johnson. As she wrote to her sister, she had decided to become the first of a new genus: a professional female writer. Having learned French and German, she translated Necker's *Of the Importance of Religious Opinions* and Saltzman's *Elements of Morality for the Use of Children*. Mary was helped in her new career by the liberal publisher, Joseph Johnson, who was also the publisher of Thomas Paine and William Godwin. Mary met these already famous authors at Johnson's dinner parties, and conversations with them helped to expand her knowledge and ambitions. Joseph Johnson was a very brave man. By publishing the works of radical authors, he was risking arrest by England's repressive government. In her letters, Mary described Johnson as "a father and brother".

At Johnson's parties Mary met, for the second time, the famous novelist and philosopher William Godwin. This time, they both formed a higher opinion of each other than at their first meeting. A passionate love affair developed between them, and when Mary became pregnant, they were married. Tragically, Mary Wollstonecraft died in childbirth. Her daughter Mary would later become the wife of Godwin's admirer, the poet Percy Bysshe Shelley, and Mary Shelly created the enduring masterpiece *Frankenstein*.



Figure 5.22: Mary Wollstonecraft in a painting by John Opie. She called Joseph Johnson “my father and brother”.



Figure 5.23: The famous scientist and dissenter, Joseph Priestley, in a portrait by Henry Fuselli, commissioned by Joseph Johnson. Priestley and Fuselli were among Johnson's closest friends.

5.10 Universal education

Today, there is some form of compulsory education in most countries. However, regional differences are still very great, as shown in the maps below.

The percentage of the global population without any schooling decreased from 36% in 1960 to 25% in 2000. In the developed countries, illiteracy rates and the number of children without schooling both were approximately halved between 1970 and 2000. However, illiteracy in the less developed countries exceeded that of the developed ones by a factor of ten in 1970. By 2000, this factor had increased to approximately 20.

As economies become more and more knowledge-based, high and higher educational levels of education are required. For many modern professions, students may be 30 years old before they complete their doctoral and post-doctoral educations. For this reason high educational levels are linked with lower fertility rates. Teenagers are biologically ready to have children, but in modern societies, they are not yet sufficiently educated to obtain well-paid work.

Suggestions for further reading

1. Phillip Bricker and R.I.G. Hughs, *Philosophical Perspectives on Newtonian Science*, M.I.T. Press, Cambridge, Mass., (1990).
2. Zev Bechler, *Newton's Physics and the Conceptual Structure of the Scientific Revolution*, Kluwer, Dordrecht, (1991).
3. Zev Bechler, *Contemporary Newtonian Research*, Reidel, Dordrecht, (1982).
4. I. Bernard Cohen, *The Newtonian Revolution*, Cambridge University Press, (1980).
5. B.J.T. Dobbs, *The Janus Face of Genius; The Role of Alchemy in Newton's Thought*, Cambridge University Press, (1991).
6. Paul B. Scheurer and G. Debrock, *Newton's Scientific and Philosophical Legacy*, Kluwer, Dordrecht, (1988).
7. A. Rupert Hall, *Isaac Newton, Adventurer in Thought*, Blackwell, Oxford, (1992).
8. Frank Durham and Robert D. Purrington, *Some Truer Method; Reflections on the Heritage of Newton*, Columbia University Press, New York, (1990).
9. John Fauvel, *Let Newton Be*, Oxford University Press, (1989).
10. René Taton and Curtis Wilson, *Planetary Astronomy from the Renaissance to the Rise of Astrophysics*, Cambridge University Press, (1989).
11. Brian Vickers, *English Science, Bacon to Newton*, Cambridge University Press, (1989).
12. John G. Burke, *The Uses of Science in the Age of Newton*, University of California Press, (1983).
13. A.I. Sabra, *Theories of Light from Descartes to Newton*, Cambridge University Press, (1991).
14. E.N. da Costa Andrade, *Isaac Newton*, Folcroft Library Editions, (1979).
15. Gideon Freudenthal, *Atom and Individual in the Age of Newton*, Reidel, Dordrecht, (1986).

16. Henry Guerlac, *Newton on the Continent*, Cornell University Press, (1981).
17. A.R. Hall, *Philosophers at War; the Quarrel Between Newton and Leibnitz*, Cambridge University Press, (1980).
18. Gale E. Christianson, *In the Presence of the Creator; Isaac Newton and his Times*, Free Press, New York, (1984).
19. Lesley Murdin, *Under Newton's Shadow; Astronomical Practices in the Seventeenth Century*, Hilger, Bristol, (1985).
20. H.D. Anthony, *Sir Isaac Newton*, Collier, New York (1961).
21. Sir Oliver Lodge, *Pioneers of Science*, Dover, New York (1960).

Chapter 6

AN EXPLOSION OF TECHNOLOGY

We have seen how the development of printing in Europe produced a brilliant, chainlike series of scientific discoveries. During the 17th century, the rate of scientific progress gathered momentum, and in the 18th and 19th centuries, the practical applications of scientific knowledge revolutionized the methods of production in agriculture and industry.

During the Industrial Revolution, feudal society, with its patterns of village life and its traditional social obligations, was suddenly replaced by a money-dominated society whose rules were purely economic, and in which labor was regarded as a commodity. The changes produced by the industrial revolution at first resulted in social chaos - enormous wealth in some classes of society, and great suffering in other classes; but later, after the appropriate social and political adjustments had been made, the improved methods of production benefited all parts of society in a more even way.

6.1 Development of the steam engine

The discovery of atmospheric pressure

Early steam engines made use of the pressure of the atmosphere, and in fact it was the discovery of atmospheric pressure that led to the invention of the steam engine. Aristotle had maintained “nature abhors a vacuum”, but this doctrine was questioned by the Italian physicist Evangelista Torricelli (1608-1647), who invented the barometer in 1643.

Pump makers working for the Grand Duke of Tuscany had found that suction pumps were unable to raise water to heights greater than 10 meters (in today’s units). Attempting to understand why this should be the case, Torricelli filled an approximately 1-meter-long glass tube with mercury, which is 14 times denser than water. The tube was sealed at one end, and open at the other. He then immersed the open end in a dish of mercury, and raised the sealed end, so that the tube was in a vertical position. Part of the mercury flowed out of the tube into the dish, leaving a 76-centimeter-high column of mercury, and

24 centimeters of empty space at the top. The empty space contained what we now call a Torricellian vacuum.

This experiment enabled Torricelli to understand why the Grand Duke's suction pumps were unable to raise water to a height greater than 10 meters. Torricelli realized that both the 10 meter column of water (the maximum that could be achieved), and the (equally heavy) 76 centimeter column of mercury, were held in place by the weight of the atmosphere, which they exactly balanced. Later experiments soon demonstrated that the height of the column of mercury in Torricelli's barometer depended on the weather, and on height above sea level. Summarizing his experiments, Torricelli wrote: "We live submerged at the bottom of an ocean of elementary air, which is known by incontestable experiments to have weight."

Toricelli's experiments marked the start of period where, throughout Europe, much interest was focused on experiments with gases. In 1650 Otto von Guericke, the Mayor of Magdeburg Germany, invented the first vacuum pump. In a dramatic experiment, performed in 1663 in the presence of Frederick Wilhelm I of Brandenburg, von Guericke's assistants fitted two large copper hemispheres together, after the joining surfaces had been carefully greased to make the junction airtight. Von Guericke's pump was then used to evacuate the volume within the hemispheres. To the amazement of the watching crowd, a team of 24 horses, 12 on each side, strained at the hemispheres but failed to separate them. Von Guericke explained that it was the pressure of the atmosphere that held the hemispheres so tightly together, and he demonstrated that when air was allowed to enter the interior volume, the hemispheres could be separated without effort.

Steam engines using atmospheric pressure

Continuing the vogue for experiments with gases and pumps that was sweeping across Europe, Edward Somerset, the 2nd Marquess of Worcester, designed steam-powered pumps to bring water from wells to fountains. He published the designs for his engines in 1663, and he may have installed pumps built according to these designs at Vauxhall House in London. In the 1680's a number of steam-powered pumps were constructed for Louis XIV of France by Sir Samuel Morland (1625-1695), who lived in Vauxhall and may have been influenced by Somerset's ideas.

Meanwhile, in France, the physicist Denis Papin (1647-1712) had become interested in the motive force of steam. Together with Gottfried Leibniz he invented the pressure cooker, and he also invented designs for steam engines. Some of Papin's steam engine designs were presented to the Royal Society between 1707 and 1712, without acknowledgment or payment, and this caused Papin to complain bitterly. He died soon afterward.

In 1698, the English inventor Thomas Savery (1650-1715) patented a steam engine for pumping water. It had no piston, but used condensing steam and atmospheric pressure to bring up the water by means of a siphon principle. It was therefore useless for pumping water from very deep mines, although Savery described it as the "Miner's Friend". Savery's design was so similar to Somerset's that it was probably a direct copy.

The ironmonger Thomas Newcomen's "atmospheric-engine" of 1712 proved to be much

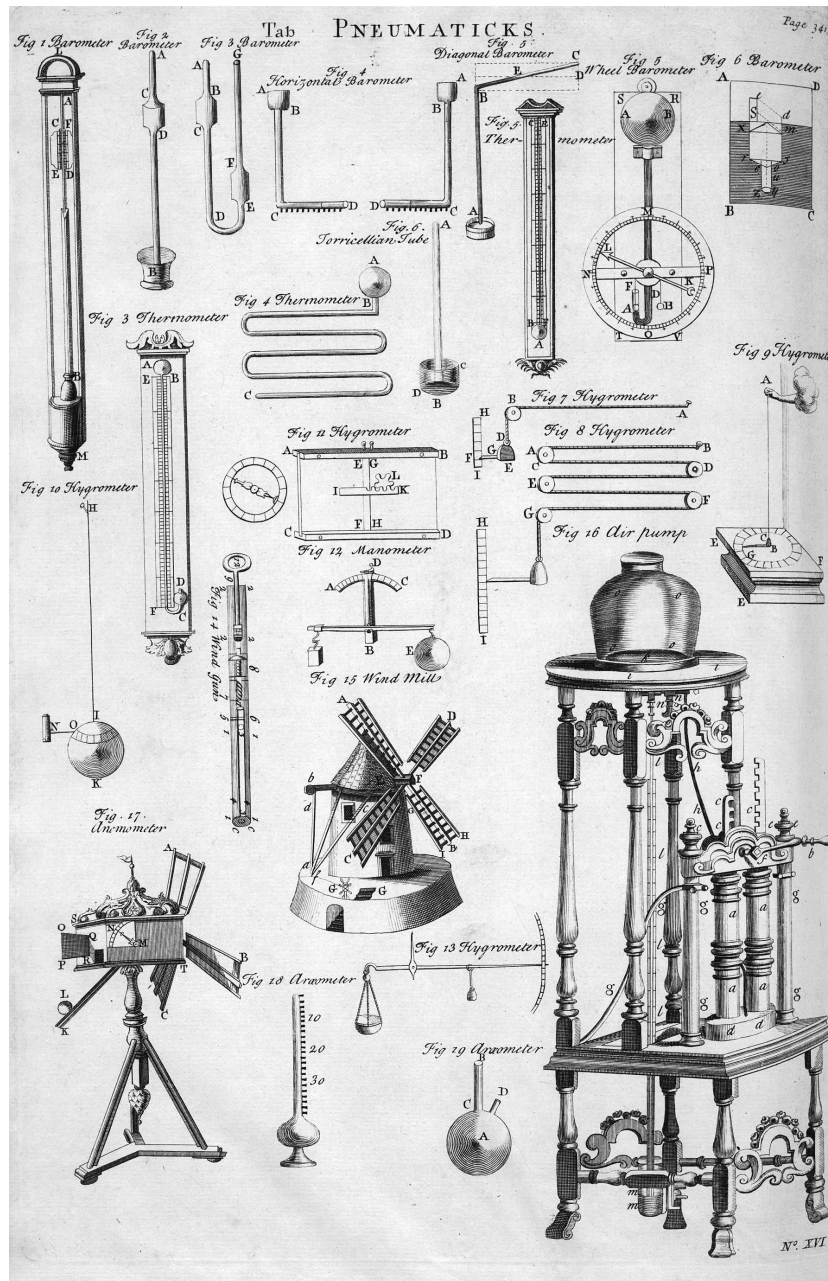

Figure 6.1: “Table of Pneumaticks” (1728).

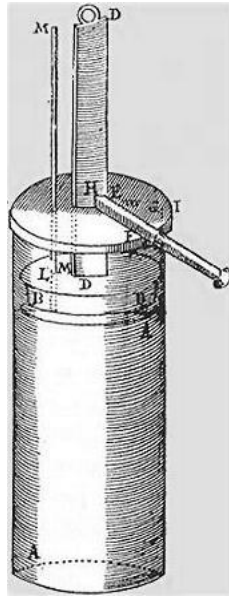

Figure 6.2: **The French physicist Papin’s design for a steam engine (1690).**

more practical for pumping water from the deep mines of Cornwall. Newcomen was forced to go into a partnership with Savery because of the latter’s patent, and he also used some of Papin’s ideas. An important feature of Newcomen’s engine was a beam that transmitted power from the working piston to a pump at the base of the mineshaft. In Newcomen’s engine, steam entered the cylinder, driving the piston upward. A jet of water was then sprayed into the interior of the cylinder, condensing the steam and allowing atmospheric pressure to drive the piston down. Early models of the engine operated slowly, and the valves were opened and closed by hand. Later, the opening and closing of the valves was performed automatically by means of the “potter cord”. According to legend this device is named after a boy, Humphrey Potter, who in 1713 had been given the job of opening and closing the valves. Wishing to play with his friends, he invented the automatic mechanism.

The main problem with Newcomen’s engine was that its fuel use was enormously wasteful. This was because, with every cycle, the cylinder was cooled by water, and then heated again by steam.

At Glasgow University, where Adam Smith was Professor of Moral Philosophy, there was a shop where scientific instruments were made and sold. The owner of the shop was a young man named James Watt (1736-1819), who came from a family of ship builders and teachers of mathematics and navigation. Besides being an extremely competent instrument maker, Watt was a self-taught scientist of great ability, and his shop became a meeting place for scientifically inclined students.

James Watt tried to repair the university’s small-scale model of the Newcomen engine, but he failed to make it work well. He could see that it was extraordinarily inefficient in its use of fuel, and he began making experiments to find out why it was so wasteful. James Watt quickly found the answer: The engine was inefficient because of the large amounts of

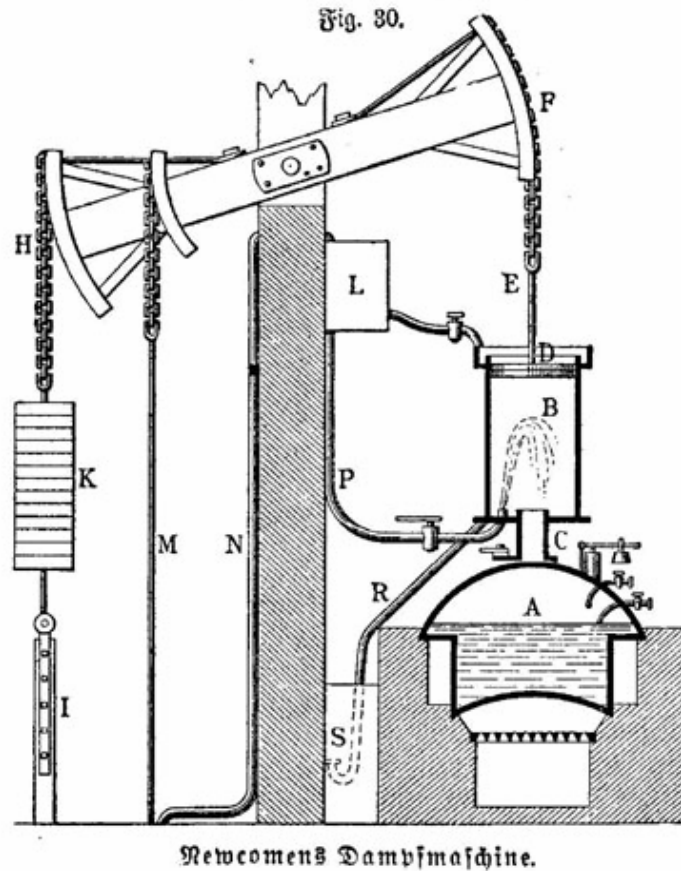

Figure 6.3: Newcomen's steam engine.

energy needed to heat the iron cylinder. In 1765, Watt designed an improved engine with a separate condenser. The working cylinder could then be kept continuously hot.

To have an idea for a new, energy-saving engine was one thing, however, and to make the machine practical was another. James Watt had experience as an instrument maker, but no experience in large-scale engineering. However, Watt formed a partnership with Matthew Boulton, who was the most talented and progressive manufacturer in England.

Boulton was more interested in applying art and science to manufacturing than he was in simply making money. His idea was to bring together under one roof the various parts of the manufacturing process which had been scattered among many small workshops by the introduction of division of labor. He believed that improved working conditions would result in an improved quality of products.

With these ideas in mind, Matthew Boulton built a large mansion-like house on his property at Soho, outside Birmingham, and installed in it all the machinery necessary for the complete production of a variety of small steel products. Because of his personal charm, and because of the comfortable working conditions at the Soho Manufactory, Boulton was able to attract the best and most skillful craftsmen in the region; and by 1765, the number of the staff at Soho had reached 600.

At this point, Erasmus Darwin (the grandfather of Charles Darwin) introduced James Watt to Matthew Boulton, and they formed a partnership for the development of the steam engine. The high quality of craftsmanship and engineering skill which Matthew Boulton was able to put at Watt's disposal allowed the young inventor to turn his great idea into a reality. However, progress was slow, and the original patent was running out.

Boulton skillfully lobbied in Parliament for an extension of the patent and, as James Watt put it, "Mr. Boulton's amiable and friendly character, together with his fame as an ingenious and active manufacturer procured me many and very active friends in both houses of Parliament".

In 1775, the firm of Boulton and Watt was granted an extension of the master steam engine patent until 1800. From a legal and financial standpoint, the way was now clear for the development of the engine; and a major technical difficulty was overcome when the Birmingham ironmaster and cannon-maker, John Wilkinson, invented a method for boring large cylinders accurately by fixing the cutting tool to a very heavy and stable boring shaft.

By 1780, Boulton and Watt had erected 40 engines, about half of which pumped water from the deep Cornish tin mines. Even their early models were at least four times as efficient as the Newcomen engine, and Watt continually improved the design. At Boulton's urging, James Watt designed rotary engines, which could be used for driving mills; and he also invented a governor to regulate the speed of his engines, thus becoming a pioneer of automation. By the time its patent of the separate condenser had run out in 1800, the firm of Boulton and Watt had made 500 engines. After 1800, the rate of production of steam engines became exponential, and when James Watt died in 1819, his inventions had given employment, directly or indirectly, to an estimated two million people.

The Soho manufactory became an almost obligatory stop on any distinguished person's tour of England. Samuel Johnson, for example, wrote that he was received at Soho with great civility; and Boswell, who visited Soho on another occasion, was impressed by "the vastness and contrivance" of the machinery. He wrote that he would never forget Matthew Boulton's words to him as they walked together through the manufactory: "I sell here, Sir, what all the world desires to have - Power!"

6.2 Working conditions

Both Matthew Boulton and James Watt were model employers as well as pioneers of the factory system. Boulton had a pension scheme for his men, and he made every effort to insure that they worked under comfortable conditions. However, when he died in 1809, the firm of Boulton and Watt was taken over by his son, Matthew Robinson Boulton, in partnership with James Watt Jr. The two sons did not have their fathers' sense of social responsibility; and although they ran the firm very efficiently, they seemed to be more interested in profit-making than in the welfare of their workers.

A still worse employer was Richard Arkwright (1732-1792), who held patents on a series of machines for carding, drawing and spinning silk, cotton, flax and wool. He was a rough, uneducated man, who rose from humble origins to become a multimillionaire by driving



Figure 6.4: **Manchester in the 1840's.**

himself almost as hard as he drove his workers. Arkwright perfected machines (invented by others) which could make extremely cheap and strong cotton thread; and as a result, a huge cotton manufacturing industry grew up within the space of a few years. The growth of the cotton industry was especially rapid after Arkwright's patent expired in 1785.

Crowds of workers, thrown off the land by the Enclosure Acts and by the Clearances in Scotland, flocked to the towns, seeking work in the new factories¹. Wages fell to a near-starvation level, hours of work increased, and working conditions deteriorated. Dr. Peter Gaskell, writing in 1833, described the condition of the English mill workers as follows:

“The vast deterioration in personal form which has been brought about in the manufacturing population during the last thirty years... is singularly impressive, and fills the mind with contemplations of a very painful character... Their complexion is sallow and pallid, with a peculiar flatness of feature caused by the want of a proper quantity of adipose substance to cushion out the cheeks. Their stature is low - the average height of men being five feet, six inches... Great numbers of the girls and women walk lamely or awkwardly... Many of the men have but little beard, and that in patches of a few hairs... (They have) a spiritless and dejected air, a sprawling and wide action of the legs...”

“Rising at or before daybreak, between four and five o'clock the year round, they swallow a hasty meal or hurry to the mill without taking any food whatever... At twelve

¹During the Highland Clearances, families that had farmed the land for generations were violently forced to leave their houses, which were then burned to prevent return. The land was afterward used as pasturage for sheep, which had been found to be more profitable. Donald McLeod, a crofter (small farmer) in Sutherland, has left the following account of the Clearances in his district: “The consternation and confusion were extreme. Little or no time was given for the removal of persons or property; the people striving to remove the sick and helpless before the fire should reach them; next, struggling to save the most valuable of their effects. The cries of the women and children, the roaring of the affrighted cattle, hunted at the same time by the yelling dogs of the shepherds amid the smoke and fire, altogether presented a scene that completely baffles description - it required to be seen to be believed... The conflagration lasted six days, until the whole of the dwellings were reduced to ashes or smoking ruins.”



Figure 6.5: **London during the industrial revolution.**

o'clock the engine stops, and an hour is given for dinner... Again they are closely immured from one o'clock till eight or nine, with the exception of twenty minutes, this being allowed for tea. During the whole of this long period, they are actively and unremittingly engaged in a crowded room at an elevated temperature."

Dr. Gaskell described the housing of the workers as follows:

"One of the circumstances in which they are especially defective is that of drainage and water-closets. Whole ranges of these houses are either totally undrained, or very partially... The whole of the washings and filth from these consequently are thrown into the front or back street, which, often being unpaved and cut into deep ruts, allows them to collect into stinking and stagnant pools; while fifty, or even more than that number, having only a single convenience common to them all, it is in a very short time choked with excrementous matter. No alternative is left to the inhabitants but adding this to the already defiled street."

"It frequently happens that one tenement is held by several families... The demoralizing effects of this utter absence of domestic privacy must be seen before they can be thoroughly appreciated. By laying bare all the wants and actions of the sexes, it strips them of outward regard for decency - modesty is annihilated - the father and the mother, the brother and the sister, the male and female lodger, do not scruple to commit acts in front of each other which even the savage keeps hid from his fellows."

"Most of these houses have cellars beneath them, occupied - if it is possible to find a lower class - by a still lower class than those living above them."



Figure 6.6: A child working in a South Carolina mill in 1908.

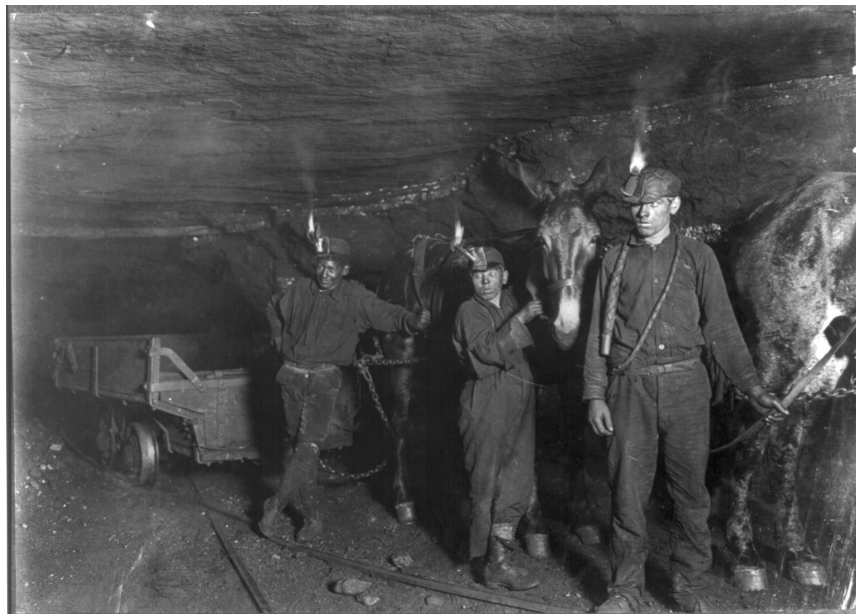

Figure 6.7: Child coal miners in Gary, West Virginia.

The following extract from John Fielden's book, *The Curse of the Factory System* (1836), describes the condition of young children working in the cotton industry:

"It is well known that Arkwright's (so called at least) inventions took manufactures out of the cottages and farmhouses of England... and assembled them in the counties of Derbyshire, Nottinghamshire and more particularly, in Lancashire, where the newly-invented machinery was used in large factories built on the side of streams capable of turning the water wheel. Thousands of hands were suddenly required in these places, remote from towns."

"The small and nimble fingers of children being by far the most in request, the custom instantly sprang up of procuring 'apprentices' from the different parish workhouses of London, Birmingham and elsewhere... Overseers were appointed to see to the works, whose interest it was to work the children to the utmost, because their pay was in proportion to the quantity of work which they could exact."

"Cruelty was, of course, the consequence; and there is abundant evidence on record to show that in many of the manufacturing districts, the most heart-rending cruelties were practiced on the unoffending and friendless creatures... that they were flogged, fettered and tortured in the most exquisite refinement of cruelty, that they were, in many cases, starved to the bone while flogged to their work, and that even in some instances they were driven to commit suicide... The profits of manufacture were enormous; but this only whetted the appetite it should have satisfied."

The misery of factory workers in England during the early phases of the Industrial Revolution prompted the writings of Karl Marx (1818-1883) and Frederick Engels (1820-1895). Engels' book, *The condition of the Working Class in England*, was published in 1844. *The Communist Manifesto*, (*Manifest der Kommunistischen Partei*), on which Marx and Engels collaborated, was published in 1848, while Marx's large book, *Das Kapital. Kritik der politischen Oekonomie* was printed in 1867.

One of the arguments which was used to justify the abuse of labor was that the alternative was starvation. The population of Europe had begun to grow rapidly for a variety of reasons: - because of the application of scientific knowledge to the prevention of disease; because the potato had been introduced into the diet of the poor; and because bubonic plague had become less frequent after the black rat had been replaced by the brown rat, accidentally imported from Asia.

It was argued that the excess population could not be supported unless workers were employed in the mills and factories to produce manufactured goods, which could be exchanged for imported food. In order for the manufactured goods to be competitive, the labor which produced them had to be cheap: hence the abuses. (At least, this is what was argued).

6.3 The slow acceptance of birth control in England

Industrialization benefited England, but in a very uneven way, producing great wealth for some parts of society, but also extreme misery in other social classes. For many, technical

progress by no means led to an increase of happiness. The persistence of terrible poverty in 19th-century England, and the combined pessimism of Ricardo and Malthus, caused Thomas Carlyle to call economics “the Dismal Science”.

Fortunately, Ricardo’s “Iron Law of Wages” seems to have rusted over the years. Apparently it was not an eternal law, but only a description of a passing phase of industrialism, before the appropriate social and legislative adjustments had been made. Among the changes which were needed to insure that the effects of technical progress became beneficial rather than harmful, the most important were the abolition of child labor, the development of unions, the minimum wage law, and the introduction of birth control.

Francis Place (1771-1854), a close friend of William Godwin and James Mill, was one of the earliest and most courageous pioneers of these needed changes. Place had known extreme poverty as a child, but he had risen to become a successful businessman and a leader of the trade union movement.

Place and Mill were Utilitarians, and like other members of this movement they accepted the demographic studies of Malthus while disagreeing with Malthus’ rejection of birth control. They reasoned that since abortion and infanticide were already widely used by the poor to limit the size of their families, it was an indication that reliable and humane methods of birth control would be welcome. If marriage could be freed from the miseries which resulted from excessive numbers of children, the Utilitarians believed, prostitution would become less common, and the health and happiness of women would be improved.

Francis Place and James Mill decided that educational efforts would be needed to make the available methods of birth control more widely known and accepted. In 1818, Mill cautiously wrote “The great problem of a real check to population growth has been miserably evaded by all those who have meddled with the subject... And yet, if the superstitions of the nursery were discarded, and the principle of utility kept steadily in view, a solution might not be very difficult to be found.”

A few years later, Mill dared to be slightly more explicit: “The result to be aimed at”, he wrote in his *Elements of Political Economy* (1821), “is to secure to the great body of the people all the happiness which is capable of being derived from the matrimonial union, (while) preventing the evils which the too rapid increase of their numbers would entail. The progress of legislation, the improvement of the education of the people, and the decay of superstition will, in time, it may be hoped, accomplish the difficult task of reconciling these important objects.”

In 1822, Francis Place took the considerable risk of publishing a four-page pamphlet entitled *To the Married of Both Sexes of the Working People*, which contained the following passages:

“It is a great truth, often told and never denied, that when there are too many working people in any trade or manufacture, they are worse paid than they ought to be paid, and are compelled to work more hours than they ought to work. When the number of working people in any trade or manufacture has for some years been too great, wages are reduced very low, and the working people become little better than slaves.”

“When wages have thus been reduced to a very small sum, working people can no longer maintain their children as all good and respectable people wish to maintain their

children, but are compelled to neglect them; - to send them to different employments; - to Mills and Manufactories, at a very early age. The miseries of these poor children cannot be described, and need not be described to you, who witness them and deplore them every day of your lives.”

“The sickness of yourselves and your children, the privation and pain and premature death of those you love but cannot cherish as you wish, need only be alluded to. You know all these evils too well.”

“And what, you will ask, is the remedy? How are we to avoid these miseries? The answer is short and plain: the means are easy. Do as other people do, to avoid having more children than they wish to have, and can easily maintain.”

“What is to be done is this. A piece of soft sponge is tied by a bobbin or penny ribbon, and inserted just before the sexual intercourse takes place, and is withdrawn again as soon as it has taken place. Many tie a sponge to each end of the ribbon, and they take care not to use the same sponge again until it has been washed. If the sponge be large enough, that is, as large as a green walnut, or a small apple, it will prevent conception... without diminishing the pleasures of married life...”

“You cannot fail to see that this address is intended solely for your good. It is quite impossible that those who address you can receive any benefit from it, beyond the satisfaction which every benevolent person and true Christian, must feel, at seeing you comfortable, healthy and happy.”

The publication of Place’s pamphlet in 1822 was a landmark in the battle for the acceptance of birth control in England. Another important step was taken in 1832, when a small book entitled *The Fruits of Philosophy or, the Private Companion of Young Married People* was published by a Boston physician named Dr. Charles Knowlton. The book contained simple contraceptive advice. It reviewed the various methods of birth control available at the time. In order for the sponge method to be reliable, Knowlton’s book pointed out, use of a saline douching solution was necessary.

For a number of years, a reprinted edition of Knowlton’s book was sold openly in London. However, in 1876 a new law against obscene publications was passed, and a bookseller was sentenced to two year’s imprisonment for selling *The Fruits of Philosophy*. Charles Bradlaugh, a liberal politician and editor, and his friend, the feminist author Mrs. Annie Besant, then decided to sell the book themselves in order to provoke a new trial. The Chief Clerk of the Magistrates, the Detective Department, and to the City Solicitor, were all politely informed of the time and place where Charles Bradlaugh and Annie Besant intended to sell Knowlton’s book, and the two reformers asked to be arrested.

In the historic trial that followed, the arguments of Malthus were used, not only by Charles Bradlaugh, who conducted his own defense, but also by the Lord Chief Justice, who instructed the jury to acquit the defendants. In the end, the jury ruled that the motives of Besant and Bradley were above reproach. However, the issue was made less clear when the jury also ruled Knowlton’s book to be obscene. The enormous publicity that accompanied the trial certainly did not harm the sales of the book!

As birth control was gradually accepted in England, the average number of children per marriage fell from 6.16 in the 1860’s to 4.13 in the 1890’s. By 1915 the figure had



Figure 6.8: **Annie Besant (1847-1933).**

fallen to 2.43. At the same time, trade unions developed, and improved social legislation was enacted. For all of these reasons, conditions improved for the English workers.

6.4 The Industrial Revolution

The development of printing in Europe produced a brilliant, chainlike series of scientific discoveries. During the 17th century, the rate of scientific progress gathered momentum, and in the 18th and 19th centuries, the practical applications of scientific knowledge revolutionized the methods of production in agriculture and industry.

The changes produced by the Industrial Revolution at first resulted in social chaos - enormous wealth in some classes of society, and great suffering in other classes; but later, after the appropriate social and political adjustments had been made, the improved methods of production benefited all parts of society in a more even way.

The Industrial Revolution marked the start of massive human use of fossil fuels. The stored energy from several hundred million years of plant growth began to be used at roughly a million times the rate at which it had been formed. The effect on human society was like that of a narcotic. There was a euphoric (and totally unsustainable) surge of growth of both population and industrial production. Meanwhile, the carbon released into the atmosphere from the burning of fossil fuels began to duplicate the conditions which led to the 5 geologically-observed mass extinctions, during each of which more than half of all living species disappeared forever.



Figure 6.9: **And was Jerusalem builded here, among these dark Satanic mills?**

6.5 Technical change

We have just seen how the development of printing in Europe produced a brilliant, chainlike series of scientific discoveries. During the 17th century, the rate of scientific progress gathered momentum, and in the 18th and 19th centuries, the practical applications of scientific knowledge revolutionized the methods of production in agriculture and industry.

The changes produced by the industrial revolution at first resulted in social chaos - enormous wealth in some classes of society, and great suffering in other classes; but later, after the appropriate social and political adjustments had been made, the improved methods of production benefited all parts of society in a more even way.

There is, in fact, a general pattern which we can notice in the social impact of technology: Technical changes usually occur rapidly, while social and political adjustments take more time. The result is an initial period of social disruption following a technical change, which continues until the structure of society has had time to adjust. Thus, for example, the introduction of a money-based economy into a society which has previously been based on a pattern of traditional social duties always creates an initial period of painful disruption.

In the case of the Industrial Revolution, feudal society, with its patterns of village life and its traditional social obligations, was suddenly replaced by an industrial society whose rules were purely economic, and in which labor was regarded as a commodity. At first, the change produced severe social disruption and suffering; but now, after two centuries of social and political adjustment, the industrialized countries are generally considered to

have benefited from the change.

Cullen, Black and Watt

The two driving forces behind the Industrial Revolution were world trade and scientific discovery. During the 18th century, both these forces were especially strongly felt in Scotland and in the north-western part of England. The distilling industry in Scotland grew enormously because of world trade; and the resulting interest in what happens when liquids are vaporized and condensed produced one of the major scientific and technical developments of the Industrial Revolution.

The first step in this development was taken by William Cullen, a professor of medicine at the universities of Glasgow and Edinburgh. In a paper entitled *Of the Cold Produced by Evaporation* (1749), Cullen wrote that he had noticed that "...water and some other liquids, in evaporating, produce some degree of cold".

Cullen therefore began to make experiments in which he dipped a thermometer in and out of a liquid and observed the drop in temperature. He noticed that the effect was increased by "...moving the thermometer very nimbly to and fro in the air; or if, while the ball was wet with spirit of wine, it was blown upon with a pair of bellows". In this way, Cullen achieved a temperature 44 degrees below the freezing point of water. He next tried producing vacuums above various liquids with the help of an air pump:

"We set the vessel containing the ether", Cullen wrote, "In another a little larger, containing water. Upon exhausting the receiver and the vessel's remaining a few minutes *in vacuo*, we found the most part of the water frozen, and the vessel containing the ether surrounded with a thick crust of ice."

One of Cullen's favorite students at Edinburgh was Joseph Black (1728-1799). He became Cullen's scientific assistant, and later, in 1756, he was elected to the Chair of Medicine at Glasgow University. Continuing Cullen's work on the cold produced by evaporating liquids, Black discovered and studied quantitatively the phenomenon of latent heats, e.g., the very large quantities of heat which are necessary to convert ice into water, or to convert water into steam.

Black was led to his discovery of latent heats not only by Cullen's work, but also by his own observations on Scottish weather. Writing of the discovery, one of Black's friends at Glasgow recorded that "...since a fine winter day of sunshine did not at once clear the hills of snow, nor a frosty night suddenly cover the ponds with ice, Dr. Black was already convinced that much heat was absorbed and fixed in the water which slowly trickled from the wreaths of snow; and on the other hand, that much heat emerged from it while it was slowly changing into ice. For, during a thaw, a thermometer will always sink when removed from the air into melting snow; and during a severe frost it will rise when plunged into freezing water. Therefore in the first case, the snow is receiving heat, and in the last, the water is allowing it to emerge again."

At Glasgow University, where Joseph Black was Professor of Medicine, there was a shop where scientific instruments were made and sold. The owner of the shop was a young man

named James Watt (1736-1819), who came from a family of ship builders and teachers of mathematics and navigation. Besides being an extremely competent instrument maker, Watt was a self-taught scientist of great ability, and his shop became a meeting place for scientifically inclined students. Dr. Black was also a frequent visitor to Watt's shop, and a strong friendship formed between the professor and the highly intelligent young instrument maker.

In 1763, Glasgow University asked James Watt to repair a model of a Newcomen steam engine. This type of steam engine had been used for several years to pump water out of mines. It had a single cylinder which filled with steam so that the piston was driven to one end. Then water was sprayed into the cylinder, condensing the steam; and the vacuum drew the piston back to the other end of the cylinder, thus completing the cycle.

James Watt tried to repair the university's small-scale model of the Newcomen engine, but he failed to make it work well. He could see that it was extraordinarily inefficient in its use of fuel, and he began making experiments to find out why it was so wasteful. Because of James Watt's friendship with Joseph Black, he quickly found the answer in the phenomena of latent heats and specific heats: The engine was inefficient because of the large amounts of energy needed to convert water into steam and to heat the iron cylinder.

In 1765, Watt designed an improved engine with a separate condenser. The working cylinder could then be kept continuously hot, and the condensing steam could be returned through the boiler, so that its latent heat could be used to preheat the incoming water. To have an idea for a new, energy-saving engine was one thing, however, and to make the machine practical was another. James Watt had experience as instrument maker, but no experience in large-scale engineering.

In 1767, Watt was engaged to make a survey for a canal which was to join the Forth and the Clyde through Loch Lomond. Because of this work, he had to make a trip to London to explain the canal project to a parliamentary committee; and on the return trip he met Dr. Erasmus Darwin in Birmingham. Darwin, who was interested in steam engines, quickly recognized Watt's talent and the merit of his idea.

Erasmus Darwin (1731-1802) was the most famous physician of the period, but his interests were by no means confined to medicine. He anticipated his grandson, Charles Darwin, by developing the first reasonably well thought-out theory of evolution; and, at the time when he met James Watt he was enthusiastically trying to design a steam locomotive. His collaborators in this project were Benjamin Franklin and the pioneering Birmingham industrialist, Matthew Boulton.

In August, 1767, Erasmus Darwin wrote to Watt: "The plan of your steam improvements I have religiously kept secret, but begin to see myself some difficulties in your execution, which did not strike me when you were here. I have got another and another hobby horse since I saw you. I wish that the Lord would send you to pass a week with me, and Mrs. Watt with you; - a week, a month, a year!"

Dr. Darwin introduced James Watt to Matthew Boulton, and a famous partnership was formed. The partnership of Boulton and Watt was destined to make the steam engine practical, and thus to create a new age - an age in which humans would rely for power neither on their own muscles nor on the muscles of slaves, but would instead control

almost unlimited power through their engines.

James Watt was lucky to meet Erasmus Darwin and to be introduced to Matthew Boulton, since Boulton was the most talented and progressive manufacturer in England - the best possible man to understand the significance of Watt's great invention and to help in its development.

Boulton

Matthew Boulton was the son of a Birmingham manufacturer, and at the age of seventeen, he had invented a type of metal buckle inlaid with glass, which proved to be extremely popular and profitable. By the time that he was twenty-one, his father had made him manager of the business. At twenty-eight, Matthew Boulton married an heiress, receiving a very large dowry. When his wife died four years later, Boulton married her younger sister, and he was given a second large fortune.

Instead of retiring from manufacturing and becoming a country gentleman, as most of his contemporaries would have done, Boulton used his wealth to try out new ideas. He tried especially to improve the quality of the goods manufactures in Birmingham. Since he was already an extremely rich man, he was more interested in applying art and science to manufacturing than he was in simply making money.

Boulton's idea was to bring together under one roof the various parts of the manufacturing process which had been scattered among many small workshops by the introduction of division of labor. He believed that improved working conditions would result in an improved quality of products.

With these ideas in mind, Matthew Boulton built a large mansion-like house on his property at Soho, outside Birmingham, and installed in it all the machinery necessary for the complete production of a variety of small steel products. Because of his personal charm, and because of the comfortable working conditions at the Soho Manufactory, Boulton was able to attract the best and most skillful craftsmen in the region; and by 1765, the number of the staff at Soho had reached 600.

Boulton continued to manufacture utilitarian goods, on which he made a profit, but he also introduced a line of goods of high artistic merit on which he gained prestige but lost money. He made fine gilt brass candelabra for both George III and Catherine the Great; and he was friendly with George III, who consulted him on technical questions.

At this point, Erasmus Darwin introduced James Watt to Matthew Boulton, and they formed a partnership for the development of the steam engine. The high quality of craftsmanship and engineering skill which Matthew Boulton was able to put at Watt's disposal allowed the young inventor to turn his great idea into a reality. However, progress was slow, and the original patent was running out.

Boulton skillfully lobbied in Parliament for an extension of the patent and, as James Watt put it, "Mr. Boulton's amiable and friendly character, together with his fame as an ingenious and active manufacturer procured me many and very active friends in both houses of Parliament".

In 1775, the firm of Boulton and Watt was granted an extension of the master steam engine patent until 1800. From a legal and financial standpoint, the way was now clear for the development of the engine; and a major technical difficulty was overcome when the Birmingham ironmaster and cannon-maker, John Wilkinson, invented a method for boring large cylinders accurately by fixing the cutting tool to a very heavy and stable boring shaft.

By 1780, Boulton and Watt had erected 40 engines, about half of which pumped water from the deep Cornish tin mines. Even their early models were at least four times as efficient as the Newcomen engine, and Watt continually improved the design. At Boulton's urging, James Watt designed rotary engines, which could be used for driving mills; and he also invented a governor to regulate the speed of his engines, thus becoming a pioneer of automation. By the time its patent of the separate condenser had run out in 1800, the firm of Boulton and Watt had made 500 engines. After 1800, the rate of production of steam engines became exponential, and when James Watt died in 1819, his inventions had given employment, directly or indirectly, to an estimated two million people.

The Soho manufactory became an almost obligatory stop on any distinguished person's tour of England. Samuel Johnson, for example, wrote that he was received at Soho with great civility; and Boswell, who visited Soho on another occasion, was impressed by "the vastness and contrivance" of the machinery. He wrote that he would never forget Matthew Boulton's words to him as they walked together through the manufactory: "I sell here, Sir, what all the world desires to have - Power!"

6.6 The Lunar Society

Matthew Boulton loved to entertain; and he began to invite his friends in science and industry to regular dinners at his home. At these dinners, it was understood by all the guests that science and philosophy were to be the topics of the conversation. This group of friends began to call themselves the "Lunar Society", because of their habit of meeting on nights when the moon was full so that they could find their way home easily afterwards.

During the early stages of the Industrial Revolution, the Lunar Society of Birmingham played a role in the development of scientific ideas which was almost as important as the role played by the Royal Society of London at the time of Isaac Newton. Among the members of this group of friends, besides Erasmus Darwin and James Watt, were the inventive and artistic pottery manufacturer, Josiah Wedgwood (the other grandfather of Charles Darwin), and the author, chemist and Unitarian minister, Joseph Priestley (1733-1804).

Joseph Priestley's interests were typical of the period: The center of scientific attention had shifted from astronomy to the newly-discovered phenomena of electricity, heat and chemistry, and to the relationship between them. Priestley, who was a prolific and popular author of books on many topics, decided to write a *History of Electricity*. He not only collected all the results of previous workers in an organized form, but also, while repeating their experiments, he made a number of original discoveries. For example, Joseph Priestley was the first to discover the inverse square law of attraction and repulsion between electrical

charges, a law which was later verified by the precise experiments of Henry Cavendish (1731-1810) and Charles Coulomb (1736-1806).

The chemistry of gases was also very much in vogue during this period. Joseph Black's medical thesis at Edinburgh University had opened the field with an elegant quantitative treatment of chemical reactions involving carbon dioxide. Black had shown that when chalk (calcium carbonate) is heated, it is changed into a caustic residue (calcium oxide) and a gas (carbon dioxide).

Black had carefully measured the weight lost by the solid residue when the gas was driven off, and he had shown that precisely the same weight was regained by the caustic residue when it was exposed to the atmosphere and reconverted to chalk. His work suggested not only that weight is conserved in chemical reactions, but also that carbon dioxide is present in the atmosphere. Black's work had initiated the use of precise weighing in chemistry, a technique which later was brought to perfection by the great French chemist, Anton Lavoisier (1743-1794).

Joseph Priestley, (who had been supplied with a large burning-glass by his brother-in-law, the wealthy ironmaster, John Wilkinson), carried out an experiment similar to Black's. He used the glass to focus the rays of the sun on a sample of what we now call red oxide of mercury. He collected the gas which was driven off, and tested its properties, recording that "...what surprized me more than I can well express was that a candle burned in this air with a remarkably vigorous flame". He also found that a mouse could live much longer in the new gas than in ordinary air.

On a trip to France, Priestley communicated these results to Anton Lavoisier, who named the gas "oxygen" and established fully its connection with combustion and respiration. At almost the same time, the Swedish chemist, Karl Wilhelm Scheele (1742-1786), discovered oxygen independently.

Joseph Priestley isolated and studied nine other new gases; and he invented the technique of collecting gases over mercury. This was much better than collecting them over water, since the gases did not dissolve in mercury. He extended Joseph Black's studies of carbon dioxide, and he invented a method for dissolving carbon dioxide in beverages under pressure, thus becoming the father of the modern soft drink industry!

The tremendous vogue for gas chemistry in the late 18th century can also be seen in the work of the eccentric multimillionaire scientist, Henry Cavendish, who discovered hydrogen by dissolving metals in acids, and then showed that when hydrogen is burned in oxygen, the resulting compound is pure water. Cavendish also combined the nitrogen in the atmosphere with oxygen by means of electrical sparks. The remaining bubble of atmospheric gas, which stubbornly refused to combine with oxygen, was later shown to be a new element - argon.

The great interest in gas chemistry shown by intelligent people of the period can be seen in Josiah Wedgwood's suggestions to the painter, George Stubbs, who was commissioned to make a portrait of Wedgwood's children:

"The two family pieces I have hinted at, I mean to contain the children only, and grouped perhaps in some such manner as this - Sukey playing upon her harpsichord with Kitty singing to her, as she often does, and Sally and Mary Ann upon the carpet in some

employment suitable to their ages. This to be one picture. The pendant to be Jack standing at a table making fixable air with the glass apparatus etc., and his two brothers accompanying him, Tom jumping up and clapping his hands in joy, and surprized at seeing the stream of bubbles rise up just as Jack has put a little chalk to the acid. Jos with the chemical dictionary before him in a thoughtful mood; which actions will be exactly descriptive of their respective characters.”

The force of feudal traditions was still so strong, however, that in spite of Josiah Wedgwood’s suggestions, George Stubbs painted the children on horseback, looking precisely like the children of a traditional landlord. The “fixable air” which Wedgwood mentions was the contemporary word for carbon dioxide. Josiah Wedgwood’s daughter, Sukey (Susannah), was destined to become the mother of the greatest biologist of all time, Charles Darwin.

6.7 Adam Smith

One of Joseph Black’s best friends at Glasgow University was the Professor of Moral Philosophy, Adam Smith. In 1759, Smith published a book entitled *The Theory of Moral Sentiments*, which was subtitled: *An Essay towards an Analysis of the Principles by which Men naturally judge concerning the Conduct and Character, first of their Neighbors, and afterwards of themselves.*

In this book, Adam Smith pointed out that people can easily judge the conduct of their neighbors. They certainly know when their neighbors are treating them well, or badly. Having learned to judge their neighbors, they can, by analogy, judge their own conduct. They can tell when they are mistreating their neighbor or being kind by asking themselves: “Would I want him to do this to me?” As Adam Smith put it:

“Our continual observations upon the conduct of others insensibly lead us to form to ourselves certain general rules concerning what is fit and proper to be done or avoided... It is thus the general rules of morality are formed.”

When we are kind to our neighbors, they maintain friendly relations with us; and to secure the benefits of their friendship, we are anxious to behave well towards other people. Thus, according to Adam Smith, enlightened self-interest leads men and women to moral behaviour.

In 1776, Adam Smith published another equally optimistic book, with a similar theme: *The Wealth of Nations*. In this book, he examined the reasons why some nations are more prosperous than others. Adam Smith concluded that the two main factors in prosperity are division of labor and economic freedom.

As an example of the benefits of division of labor, he cited the example of a pin factory, where ten men, each a specialist in a particular manufacturing operation, could produce 48,000 pins per day. One man drew the wire, another straightened it, a third pointed the pins, a fourth put on the heads, and so on. If each man had worked separately, doing all the operations himself, the total output would be far less. The more complicated the manufacturing process (Smith maintained), the more it could be helped by division of labor. In the most complex civilizations, division of labor has the greatest utility.

Adam Smith believed that the second factor in economic prosperity is economic freedom, and in particular, freedom from mercantilist government regulations. He believed that natural economic forces tend to produce an optimum situation, in which each locality specializes in the economic operation for which it is best suited.

Smith believed that when each individual aims at his own personal prosperity, the result is the prosperity of the community. A baker does not consciously set out to serve society by baking bread - he only intends to make money for himself; but natural economic forces lead him to perform a public service, since if he were not doing something useful, people would not pay him for it. Adam Smith expressed this idea in the following way:

“As every individual, therefore, endeavours as much as he can, both to employ his capital in support of domestic industry, and so to direct that industry that its produce may be of greatest value, each individual necessarily labours to render the annual revenue of the Society as great as he can.”

“He generally, indeed, neither intends to promote the public interest, nor knows how much he is promoting it. By preferring the support of domestic to that of foreign industry, he intends only his own security; and by directing that industry in such a manner as its produce may be of the greatest value, he intends only his own gain; and he is in this, as in many other cases, led by an invisible hand to promote an end which was no part of his intention. Nor is it always the worse for Society that it was no part of it. By pursuing his own interest, he frequently promotes that of society more effectively than when he really intends to promote it.”

In Adam Smith’s optimistic view, an “invisible hand” guides individuals to promote the public good, while they consciously seek only their own gain. This vision was enthusiastically adopted by the vigorously growing industrial nations of the west. It is the basis of much of modern history; but there proved to be shortcomings in Smith’s theory. A collection of individuals, almost entirely free from governmental regulation, each guided only by his or her desire for personal gain - this proved to be a formula for maximum economic growth; but certain modifications were needed before it could lead to widely shared happiness and social justice.

The dark, Satanic mills

Both Matthew Boulton and Josiah Wedgwood were model employers as well as pioneers of the factory system. Matthew Boulton had a pension scheme for his men, and he made every effort to insure that they worked under comfortable conditions. However, when he died in 1809, the firm of Boulton and Watt was taken over by his son, Matthew Robinson Boulton, in partnership with James Watt Jr.. The two sons did not have their fathers’ sense of social responsibility; and although they ran the firm very efficiently, they seemed to be more interested in profit-making than in the welfare of their workers.

A still worse employer was Richard Arkwright (1732-1792), who held patents on a series of machines for carding, drawing and spinning silk, cotton, flax and wool. He was a rough, uneducated man, who rose from humble origins to become a multimillionaire by driving

himself almost as hard as he drove his workers. Arkwright perfected machines (invented by others) which could make extremely cheap and strong cotton thread; and as a result, a huge cotton manufacturing industry grew up within the space of a few years. The growth of the cotton industry was especially rapid after Arkwright's patent expired in 1785.

Crowds of workers, thrown off the land by the Enclosure Acts, flocked to the towns, seeking work in the new factories. Wages fell to a near-starvation level, hours of work increased, and working conditions deteriorated. Dr. Peter Gaskell, writing in 1833, described the condition of the English mill workers as follows:

"The vast deterioration in personal form which has been brought about in the manufacturing population during the last thirty years... is singularly impressive, and fills the mind with contemplations of a very painful character... Their complexion is sallow and pallid, with a peculiar flatness of feature caused by the want of a proper quantity of adipose substance to cushion out the cheeks. Their stature is low - the average height of men being five feet, six inches... Great numbers of the girls and women walk lamely or awkwardly... Many of the men have but little beard, and that in patches of a few hairs... (They have) a spiritless and dejected air, a sprawling and wide action of the legs..."

"Rising at or before daybreak, between four and five o'clock the year round, they swallow a hasty meal or hurry to the mill without taking any food whatever... At twelve o'clock the engine stops, and an hour is given for dinner... Again they are closely immured from one o'clock till eight or nine, with the exception of twenty minutes, this being allowed for tea. During the whole of this long period, they are actively and unremittingly engaged in a crowded room at an elevated temperature."

Dr. Gaskell described the housing of the workers as follows:

"One of the circumstances in which they are especially defective is that of drainage and water-closets. Whole ranges of these houses are either totally undrained, or very partially... The whole of the washings and filth from these consequently are thrown into the front or back street, which, often being unpaved and cut into deep ruts, allows them to collect into stinking and stagnant pools; while fifty, or even more than that number, having only a single convenience common to them all, it is in a very short time choked with excrementous matter. No alternative is left to the inhabitants but adding this to the already defiled street."

"It frequently happens that one tenement is held by several families... The demoralizing effects of this utter absence of domestic privacy must be seen before they can be thoroughly appreciated. By laying bare all the wants and actions of the sexes, it strips them of outward regard for decency - modesty is annihilated - the father and the mother, the brother and the sister, the male and female lodger, do not scruple to commit acts in front of each other which even the savage keeps hid from his fellows."

"Most of these houses have cellars beneath them, occupied - if it is possible to find a lower class - by a still lower class than those living above them."

The abuse of child labor was one of the worst features of early industrialism in England. Sometimes small children, starting at the age of six or seven, were forced to work, because wages were so low that the family would otherwise starve; and sometimes the children were orphans, taken from parish workhouses. The following extract from John Fielden's book,

The Curse of the Factory System (1836), describes the condition of young children working in the cotton industry:

“It is well known that Arkwright’s (so called at least) inventions took manufactures out of the cottages and farmhouses of England... and assembled them in the counties of Derbyshire, Nottinghamshire and more particularly, in Lancashire, where the newly-invented machinery was used in large factories built on the side of streams capable of turning the water wheel. Thousands of hands were suddenly required in these places, remote from towns.”

“The small and nimble fingers of children being by far the most in request, the custom instantly sprang up of procuring ‘apprentices’ from the different parish workhouses of London, Birmingham and elsewhere... Overseers were appointed to see to the works, whose interest it was to work the children to the utmost, because their pay was in proportion to the quantity of work which they could exact.”

“Cruelty was, of course, the consequence; and there is abundant evidence on record to show that in many of the manufacturing districts, the most heart-rending cruelties were practiced on the unoffending and friendless creatures... that they were flogged, fettered and tortured in the most exquisite refinement of cruelty, that they were, in many cases, starved to the bone while flogged to their work, and that even in some instances they were driven to commit suicide... The profits of manufacture were enormous; but this only whetted the appetite it should have satisfied.”

One of the arguments which was used to justify the abuse of labor was that the alternative was starvation. The population of Europe had begun to grow rapidly for a variety of reasons: - because of the application of scientific knowledge to the prevention of disease; because the potato had been introduced into the diet of the poor; and because bubonic plague had become less frequent after the black rat had been replaced by the brown rat, accidentally imported from Asia.

It was argued that the excess population could not be supported unless workers were employed in the mills and factories to produce manufactured goods, which could be exchanged for imported food. In order for the manufactured goods to be competitive, the labor which produced them had to be cheap: hence the abuses. (At least, this is what was argued).

Overpopulation

When the facts about the abuse of industrial workers in England became known, there were various attempts to explain what had gone wrong with the optimistic expectations of the Enlightenment. Among the writers who discussed this problem was the economist David Ricardo (1772-1823). In his book, *The Principles of Political Economy and Taxation* (1817), Ricardo proposed his “iron law of wages”.

According to Ricardo, labor is a commodity, and wages are determined by the law of supply and demand: When wages fall below the starvation level, the workers’ children die. Labor then becomes a scarce commodity, and the wages rise. On the other hand, when

wages rise above the starvation level, the working population multiplies rapidly, labor becomes a plentiful commodity, and wages fall again. Thus, according to Ricardo, there is an “iron law” which holds wages at the minimum level at which life can be supported.

Ricardo’s reasoning assumes industrialists to be completely without social conscience or governmental regulation; it fails to anticipate the development of trade unionism; and it assumes that the working population will multiply without restraint as soon as their wages rise above the starvation level. This was an accurate description of what was happening in England during Ricardo’s lifetime, but it obviously does not hold for all times and all places.

A more general and complete description of the situation was given by Thomas Robert Malthus (1766-1834). Malthus came from an intellectual family: His father, Daniel Malthus, was a friend of Rousseau, Hume and Goodwin. The famous book on population by the younger Malthus grew out of his conversations with his father.

Daniel Malthus was an enthusiastic believer in the optimistic philosophy of the Enlightenment. Like Goodwin, Condorcet and Voltaire, he believed that the application of scientific progress to agriculture and industry would inevitably lead humanity forward to a golden age. His son, Robert, was more pessimistic. He pointed out that the benefits of scientific progress would probably be eaten up by a growing population.

At his father’s urging, Robert Malthus developed his ideas into a book, *An Essay on the Principle of Population*, which he published anonymously in 1798. In this famous book, Malthus pointed out that under optimum conditions, every biological population, including that of humans, is capable of increasing exponentially. For humans under optimum conditions, the population can double every twenty-five years, quadruple every fifty years and increase by a factor of 8 every seventy-five years. It can grow by a factor of 16 every century, and by a factor of 256 every two centuries, and so on.

Obviously, human populations cannot increase at this rate for very long, since if they did, the earth would be completely choked with people in a very few centuries. Therefore, Malthus pointed out, various forces must be operating to hold the population in check. Malthus listed first the “positive checks” to population growth - disease, famine and war - which we now call the “Malthusian forces”. In addition, he listed checks of another kind - birth control (which he called “Vice”), late marriage, and “Moral Restraint”. Being a clergyman, Malthus naturally favored moral restraint.

According to Malthus, a population need not outrun its food supply, provided that late marriage, birth control or moral restraint are practiced; but without these less painful checks, the population will quickly grow to the point where the grim Malthusian forces - famine, disease and war - begin to act.

Curiously, it was France, a Catholic country, which led the way in the development of birth control. Robert Owen (who was an enlightened English industrialist, and the founder of the cooperative movement), wished to advise his workers about birth control; and so he went to France to learn about the techniques practiced there. In 1825, an article (by Richard Carlile) appeared in *The Republican*. The article described the importation of birth control from France to England as follows:

“...It was suggested to Mr. Owen that, in his new establishments, the healthy state of

the inhabitants would tend to breed an excess of children. The matter was illustrated and explained to him, so that he felt the force of it. He was told that on the Continent, the women used some means of preventing conception which were uniformly successful. Mr. Owen set out for Paris to discover the process. He consulted the most eminent physicians, and assured himself of what was the common practice among their women.”

“...A piece of soft sponge is tied by a bobbin or penny ribbon, and inserted before sexual intercourse takes place, and is withdrawn again as soon as it has taken place... If the sponge be large enough, that is, as large as a green walnut or a small apple, it will prevent conception, without diminishing the pleasures of married life.”

Carlile goes on to say:

“...When the number of working people in any trade or manufacture has for some years been too great, wages are reduced very low, and the working people become little better than slaves... By limiting the number of children, the wages of both children and grown persons will rise; and the hours of working will be no more than they ought to be.”

Birth control and late marriage have (until now) kept the grim predictions of Ricardo and Malthus from being fulfilled in the developed industrial nations of the modern world. Most of these nations have gone through a process known as the “demographic transition” - the shift from an equilibrium where population growth is held in check by the Malthusian forces of disease, starvation and war, to one where it is held in check by birth control and late marriage.

The transition begins with a fall in the death rate, caused by various factors, among which the most important is the application of scientific knowledge to the prevention of disease. Cultural patterns require some time to adjust to the lowered death rate, and so the birth rate continues to be high. Families continue to have six or seven children, just as they did when most of the children died before having children of their own. Therefore, at the start of the demographic transition, the population increases sharply. After a certain amount of time, however, cultural patterns usually adjust to the lowered death rate, and a new equilibrium is established, where both the birth rate and the death rate are low.

In Europe, this period of adjustment required about two hundred years. In 1750, the death rate began to fall sharply: By 1800, it had been cut in half, from 35 deaths per thousand people in 1750 to 18 in 1800; and it continued to fall. Meanwhile, the birth rate did not fall, but even increased to 40 births per thousand per year in 1800. Thus the number of children born every year was more than twice the number needed to compensate for the deaths!

By 1800, the population was increasing by more than two percent every year. In 1750, the population of Europe was 150 million; by 1800, it was roughly 220 million; by 1950 it had exceeded 540 million, and in 1970 it was 646 million.

Meanwhile the achievements of medical science and the reduction of the effects of famine and warfare had been affecting the rest of the world: In 1750, the non-European population of the world was only 585 million. By 1850 it had reached 877 million. During the century between 1850 and 1950, the population of Asia, Africa and Latin America more than doubled, reaching 1.8 billion in 1950. In the twenty years between 1950 and 1970, the population of Asia, Africa and Latin America increased still more sharply, and in

1970, this segment of the world's population reached 2.6 billion, bringing the world total to 3.6 billion. The fastest increase was in Latin America, where population almost doubled during the twenty years between 1950 and 1970.

The latest figures show that the population explosion is leveling off in Europe, Russia, North America and Japan, where the demographic transition is almost complete. However, the population of the rest of the world is still increasing at a breakneck speed; and it cannot continue to expand at this rate for very much longer without producing widespread famine.

6.8 Colonialism

In the 18th and 19th centuries, the continually accelerating development of science and science-based industry began to affect the whole world. As the factories of Europe poured out cheap manufactured goods, a change took place in the patterns of world trade: Before the Industrial Revolution, trade routes to Asia had brought Asian spices, textiles and luxury goods to Europe. For example, cotton cloth and fine textiles, woven in India, were imported to England. With the invention of spinning and weaving machines, the trade was reversed. Cheap cotton cloth, manufactured in England, began to be sold in India, and the Indian textile industry withered.

The rapid development of technology in the west also opened an enormous gap in military strength between the industrialized nations and the rest of the world. Taking advantage of their superior weaponry, the advanced industrial nations rapidly carved the remainder of the world into colonies, which acted as sources of raw materials and food, and as markets for manufactured goods.

In North America, the native Indian population had proved vulnerable to European diseases, such as smallpox, and large numbers of them had died. The remaining Indians were driven westward by streams of immigrants arriving from Europe. In Central and South America, European diseases proved equally fatal to the Indians.

Often the industrialized nations made their will felt by means of naval bombardments: In 1854, Commodore Perry and an American fleet forced Japan to accept foreign traders by threatening to bombard Tokyo. In 1856, British warships bombarded Canton in China to punish acts of violence against Europeans living in the city. In 1864, a force of European and American warships bombarded Choshu in Japan, causing a revolution. In 1882, Alexandria was bombarded, and in 1896, Zanzibar.

Between 1800 and 1875, the percentage of the earth's surface under European rule increased from 35 percent to 67 percent. In the period between 1875 and 1914, there was a new wave of colonial expansion, and the fraction of the earth's surface under the domination of colonial powers (Europe, the United States and Japan) increased to 85 percent, if former colonies are included.

During the period between 1880 and 1914, English industrial and colonial dominance began to be challenged. Industrialism had spread from England to Belgium, Germany and the United States, and, to a lesser extent, to France, Italy, Russia and Japan. By 1914, Germany was producing twice as much steel as Britain, and the United States was

producing four times as much.

New techniques in weaponry were introduced, and a naval armaments race began among the major industrial powers. The English found that their old navy was obsolete, and they had to rebuild. Thus, the period of colonial expansion between 1880 and 1914 was filled with tensions, as the industrial powers raced to arm themselves in competition with each other, and raced to seize as much as possible of the rest of the world.

Much that was beautiful and valuable was lost, as mature traditional cultures collapsed, overcome by the power and temptations of modern industrial civilization. For the Europeans and Americans of the late 19th century and early 20th century, progress was a religion, and imperialism was its crusade. The cruelties of the crusade were justified, in the eyes of the westerners, by their mission to “civilize” and Christianize the rest of the world. To a certain extent, the industrial countries were right in feeling that they had something of value to offer to the rest of the world; and among the people whom they sent out were educators and medical workers who often accepted lives of extreme discomfort and danger in order to be of service.

At the beginning of the 19th century, the world was divided into parts: China was a world in itself; India was a separate world; Africa south of the Sahara was another enclosed world; and the Islamic world was also self-contained, as was the west. By 1900, there was only one world, bound together by constantly-growing ties of trade and communication.

6.9 Trade Unions and minimum wage laws

Robert Owen and social reform

During the early phases of the Industrial Revolution in England, the workers suffered greatly. Enormous fortunes were made by mill and mine owners, while workers, including young children, were paid starvation wages for cruelly long working days. However, trade unions, child labor laws, and the gradual acceptance of birth control finally produced a more even distribution of the benefits of industrialization.

One of the most interesting pioneers of these social reforms was Robert Owen (1771-1858), who is generally considered to have been the father of the Cooperative Movement. Although in his later years not all of his projects developed as he wished, his life started as an amazing success story. Owen’s life is not only fascinating in itself; it also illustrates some of the reforms that occurred between 1815 and 1850.

Robert Owen was born in Wales, the youngest son of a family of iron-mongers and saddle-makers. He was a very intelligent boy, and did well at school, but at the age of 9, he was apprenticed to a draper, at first in Wales. Later, at the age of 11, he was moved to London, where he was obliged to work eighteen hours a day, six days a week, with only short pauses for meals. Understandably, Robert Owen found this intolerable, and he moved again, this time to Manchester, where he again worked for a draper.

While in Manchester, Robert Owen became interested in the machines that were beginning to be used for spinning and weaving. He borrowed a hundred pounds from his brother,

and entered (as a partner) a small business that made these machines. After two years of moderate success as a small-scale industrialist, Owen saw the newspaper advertisement of a position for manager of a large spinning mill, owned by a Mr. Drinkwater.

“I put on my hat”, Owen wrote later, “and proceeded straight to Mr. Drinkwater’s counting house. ‘How old are you?’ ‘Twenty this May’, was my reply. ‘How often do you get drunk in the week?’... ‘I was never’, I said, ‘drunk in my life.’ blushing scarlet at this unexpected question. ‘What salary do you ask?’ ‘Three hundred a year’, was my reply. ‘What?’, Mr. Drinkwater said with some surprise, repeating the words, ‘Three hundred pounds! I have had this morning I know not how many seeking the situation and I do not think that all of their askings would amount to what you require.’ ‘I cannot be governed by what others seek’, said I, ‘and I cannot take less.’

Apparently impressed by Robert Owen’s success as a small-scale industrialist, and perhaps also impressed by his courage, Mr. Drinkwater hired him. Thus, at the age of 19, Owen became the manager of a large factory. Mr. Drinkwater had no cause to regret his decision, since his new manager quickly became the boy wonder of Manchester’s textile community. Within six months, Drinkwater offered Owen a quarter interest in his business.

After several highly successful years in his new job, Robert Owen heard of several mills that were for sale in the village of New Lanark, near to Glasgow. The owner, Mr. Dale, happened to be the father of the girl with whom Robert Owen had fallen in love. Instead of directly asking Dale for permission to marry his daughter, Owen (together with some business partners) first purchased the mills, after which he won the hand of the daughter.

Ownership of the New Lanark mills gave Robert Owen the chance to put into practice the ideas of social reform that he had been developing throughout his life. Instead of driving his workers by threats of punishment, and instead of subjecting them to cruelly long working hours (such as he himself had experienced as a draper’s apprentice in London), Owen made the life of his workers at New Lanark as pleasant as he possibly could. He established a creche for the infants of working mothers, free medical care, concerts, dancing, music-making, and comprehensive education, including evening classes. Instead of the usual squalid one-room houses for workers, neat two-room houses were built. Garbage was collected regularly instead of being thrown into the street. New Lanark also featured pleasant landscaped areas.

Instead of leading to bankruptcy, as many of his friends predicted, Robert Owen’s reforms led to economic success. Owen’s belief that a better environment would lead to better work was vindicated. The village, with its model houses, schools and mills, became internationally famous as a demonstration that industrialism need not involve oppression of the workers. Crowds of visitors made the journey over narrow roads from Glasgow to learn from New Lanark and its visionary proprietor. Among the twenty thousand visitors who signed the guest-book between 1815 and 1825 were the Grand Duke Nicholas of Russia (who later became Czar Nicholas I), and Princes John and Maximilian of Austria.

Robert Owen’s ideas of social reform can be seen in the following extract from an “Address to the Inhabitants of New Lanark”, which he presented on New Year’s Day, 1616: “What ideas individuals may attach to the term ‘Millennium’ I know not; but I know that society may be formed so as to exist without crime, without poverty, with



Figure 6.10: **New Lanark World Heritage village in Scotland. A view of the school.**

health greatly improved, with little, if any, misery. and with intelligence and happiness increased a hundredfold; and no obstacle whatsoever intervenes at this moment except ignorance to prevent such a state of society from becoming universal.”

Robert Owen believed that these principles could be applied not only in New Lanark but also in the wider world. He was soon given a chance to express this belief. During the years from 1816 to 1820, apart from a single year, business conditions in England were very bad, perhaps as a result of the Napoleonic Wars, which had just ended. Pauperism and social unrest were widespread, and threatened to erupt into violence. A committee to deal with the crisis was formed under the leadership of the Dukes of Kent and York.

Because of Owen’s reputation, he was asked for his opinion, but the committee was hardly expecting the answer that they received from him. Robert Owen handed the two Dukes and the other committee members a detailed plan for getting rid of pauperism by making paupers productive. They were to be settled in self-governing Villages of Cooperation, each with between 800 and 1,200 inhabitants. Each family was to have a private apartment, but there were to be common sitting rooms, reading rooms and kitchens. Near to the houses, there were to be gardens tended by the children, and farther out, fields to be cultivated by the adults. Still farther from the houses, there was to be a small factory.

Owen’s idea for governmentally-planned paupers’ collectives was at first rejected out of hand. The early 19th century was, after all, a period of unbridled *laissez-faire* economics. Owen then bombarded the Parliament with pamphlets advocating his scheme. Finally a committee was formed to try to raise the money to establish one Village of Cooperation as an experiment; but the money was never raised.

Unwilling to accept defeat, Robert Owen sold his interest in New Lanark and sailed for America, where he believed that his social experiment would have a better chance of success. He bought the town of Harmonie and 30,000 acres of land on the banks of the Wabash River in Indiana. There he established a Village of Cooperation which he named “New Harmony”. He dedicated it on the 4th of July, 1826. It remained a collective for only two years, after which individualism reasserted itself. Owen’s four sons and one of his daughters made their homes in New Harmony, and it also became the home of numerous scientists, writers and artists.

Owen’s son, Robert Dale Owen, became a member of the U.S. House of Representatives, where he introduced the bill establishing the Smithsonian Institution. In 1862 he wrote an eloquent letter to Abraham Lincoln urging emancipation of the slaves. Three days later, probably influenced by Owen’s letter, Lincoln read the Emancipation Proclamation to his cabinet. Another son, Richard Owen, served as President of the University of Indiana, and was later elected as the first President of Purdue University.

When Robert Owen returned to England shortly after dedicating New Harmony, he found that he had become a hero of the working classes. They had read his writings avidly, and had begun to establish cooperatives, following his principles. There were both producer’s cooperatives and consumer’s cooperatives. In England, the producer’s cooperatives failed, but in Denmark they succeeded².

One of the early consumer’s cooperatives in England was called the Rochdale Society of Equitable Pioneers. It was founded by 28 weavers and other artisans, who were being forced into poverty by mechanization. They opened a small cooperative store selling butter, sugar, flour, oatmeal and candles. After a few months, they also included tobacco and tea. From this small beginning, the Cooperative Movement grew, finally becoming one of the main pillars of the British Labour Party.

Robert Owen’s attention now turned from cooperatives to the embryonic trade union movement, which was struggling to establish itself in the face of fierce governmental opposition. He assembled the leaders of the working class movement and proposed the formation of the “Grand National Moral Union of Productive and Useful Classes”. The name was soon shortened to “The Grand National Consolidated Trades Union” or simply the “Grand National”.

Owen’s Grand National was launched in 1833, and its membership quickly grew to half a million. It was the forerunner of modern nationwide trade unions, but it lasted only two years. Factory-owners saw the Grand National as a threat, and they persuaded the government to prosecute it under anti-union laws. Meanwhile, internal conflicts helped to destroy the Grand National. Owen was accused of atheism by the working class leaders, and he accused them of fermenting class hatred.

Robert Owen’s influence helped to give raw *laissez faire* capitalism a more human face, and helped to spread the benefits of industrialization more widely. Through the work of other reformers like Owen, local trade unions succeeded, both in England and elsewhere;

²The success of Danish agricultural producer’s cooperatives was helped by the People’s High School movement, founded by N.F.S. Grundvig (1783-1872).



Figure 6.11: Robert Owen, (1771-1858), founder of the Cooperative Movement.

and in the end, successful national unions were finally established. The worst features of the early Industrial Revolution were moderated by the growth of the trade union movement, by child labor laws, by birth control and by minimum wage laws.

Rusting of the Iron Law

David Ricardo's Iron Law of Wages maintained that workers must necessarily live at the starvation level: Their wages are determined by the law of supply and demand, Ricardo said. If the wages should increase above the starvation level, more workers' children would survive, the supply of workers would increase, and the wages would fall again. This gloomy pronouncement was enthusiastically endorsed by members of the early 19th century Establishment, since it absolved them from responsibility for the miseries of the poor. However, the passage of time demonstrated that the Iron Law of Wages held only under the assumption of an economy totally free from governmental intervention.

Both the growth of the political power of industrial workers, and the gradual acceptance of birth control were important in eroding Ricardo's Iron Law. Birth control is especially important in countering the argument used to justify child labor under harsh conditions. The argument (still used in many parts of the world) is that child labor is necessary in order to save the children from starvation, while the harsh conditions are needed because if a business provided working conditions better than its competitors, it would go out of business. However, with a stable population and appropriate social legislation prohibiting both child labor and harsh working conditions, the Iron Law argument fails.

6.10 Rising standards of living

Since the year 1000, world population has risen 22-fold, global per capita Gross Domestic Product 13-fold, and world GDP nearly 300-fold. These data come from Angus Maddison's recent book, *World Population, GDP and Per Capita GDP, 1-2003*. More detailed data, from a report that Prof. Maddison presented to the British House of Lords, are shown in Tables 5.1 and 5.2.

During the period between 1820 and 2001, the average years of education per person employed increased from 2.00 years to 15.45 years in the United Kingdom, from 1.75 years to 20.21 years in the United States, and from 1.50 years to 16.61 years in Japan. This increased education in the highly industrialized countries was necessary because of the complexity of modern machines and modern life.

Today, most citizens of the industrialized countries have lives of greatly-increased pleasure and freedom compared with the lives of their great-grandparents. Furthermore, their lives are also remarkably easy and pleasant compared with the remainder of the world. In later chapters we will try to discuss to what extent this privileged life-style is sustainable.

Table 6.1: GDP per capita (1990 int. \$). Data from Maddison.

| | 1900 | 1950 | 1990 | 2001 |
|------------|-------|-------|--------|--------|
| W. Europe | 2,893 | 4,579 | 15,966 | 19,256 |
| USA | 4,091 | 9,561 | 23,201 | 27,948 |
| Ca.,Au.,NZ | 3,435 | 7,424 | 17,902 | 21,718 |
| Japan | 1,180 | 1,921 | 18,789 | 20,683 |
| E. Europe | 1,438 | 2,111 | 5,450 | 6,207 |
| fUSSR | 1,237 | 2,841 | 6,878 | 4,626 |
| L. America | 1,109 | 2,506 | 5,053 | 5,811 |
| China | 545 | 439 | 1,858 | 3,583 |
| India | 599 | 619 | 1,309 | 1,957 |
| Other Asia | 802 | 919 | 3,084 | 3,997 |
| Africa | 601 | 894 | 1,444 | 1,489 |
| World | 1,262 | 2,111 | 5,157 | 6,049 |

Table 6.2: Gross stock of machinery and equipment per capita (1990 \$). Data from Maddison. These figures are a measure of the degree of industrialization of the countries shown. Similar increases occurred in the gross stock of non-residential structures per capita. For example, in the USA the value of these structures increased from \$1,094 (1990 \$) in 1820 to \$36,330 in 2001. In Japan there was a dramatic increase during the 20th century, from \$852 per capita in 1913 to \$57,415 in 2001.

| | UK | USA | Japan |
|------|--------|--------|--------|
| 1820 | 92 | 87 | na |
| 1870 | 334 | 489 | 94 |
| 1913 | 878 | 2,749 | 329 |
| 1950 | 2,122 | 6,110 | 1,381 |
| 1973 | 6,203 | 10,762 | 6,431 |
| 2001 | 16,082 | 30,600 | 32,929 |

6.11 Robber barons and philanthropists

“Hain’t I got the power?”

We can experience some of the flavor of early American industrial growth by looking at the life of Cornelius Vanderbilt (1794-1877). In those days, the United States was a place where a man with luck, intelligence and energy, could start with nothing and become a multimillionaire. That is exactly what Vanderbilt did.

Vanderbilt was born into a poor New York family. He quit school at 11 to help his father, and later remarked, “If I had learned education, I wouldn’t have had time to learn anything else.” At 16 he started his first business, using \$100 borrowed from his mother - a small ferry boat between New York and Staten Island, charging 18 cents per trip. The business succeeded because of the fair price that he charged and because of his prodigious work. Within a year, he was able to give his mother \$1,000 in return for her loan.

During the War of 1812, Vanderbilt had a government contract to sail supplies to forts in the New York area. He was by then operating a small fleet of sailing schooners, and as a consequence he received the nickname, “Commodore”.

Cornelius Vanderbilt then became interested in steamships, but Robert Fulton and Robert Livingston had been granted a 30-year monopoly on the steamboat trade. This did not stop Vanderbilt. He started a competing steam line, and his boat evaded capture. Finally a Supreme Court decision broke the Fulton-Livingston monopoly. By the 1840’s, Vanderbilt was operating about 100 steamships, and his business had the most employees of any in the United States.

Turning his attention to railways, Vanderbilt bought several lines, including the New York and Harlem Railroad, the Hudson River Railroad, and the New York Central Railroad. He extended his lines as far as Chicago, and attempted to acquire the Erie Railroad. This brought him into conflict with the unscrupulous financier Jim Fisk. Vanderbilt’s methods were equally rough, so it was a fight with no holds barred. (Cornelius Vanderbilt once remarked, “What do I care about the law? Hain’t I got the power?”)

At the time of his death, Cornelius Vanderbilt was one of the richest men in the United States, with a fortune of over \$100,000,000. He left most of this amount to his son William³, but gave one million to Central University, which then became Vanderbilt University.

Carnegie’s philanthropies

We can contrast Vanderbilt’s relatively small interest in philanthropy with Andrew Carnegie’s large-scale efforts for public improvement. Like Vanderbilt, Andrew Carnegie (1835-1919) was a self-made multimillionaire, but after making a fortune in oil wells, steel, iron ore and railways, he gave almost all of his money away. Early in his career, he wrote:

“I propose to take an income no greater than \$50,000 per annum! Beyond this I need never earn, make no effort to increase my fortune, but spend the surplus each year for benevolent purposes! Let us cast aside business forever, except for others. Let us settle in

³William Vanderbilt is best remembered for his remark, “The public be damned!”



Figure 6.12: Cornelius “Commodore” Vanderbilt.



Figure 6.13: Andrew Carnegie circa 1878.

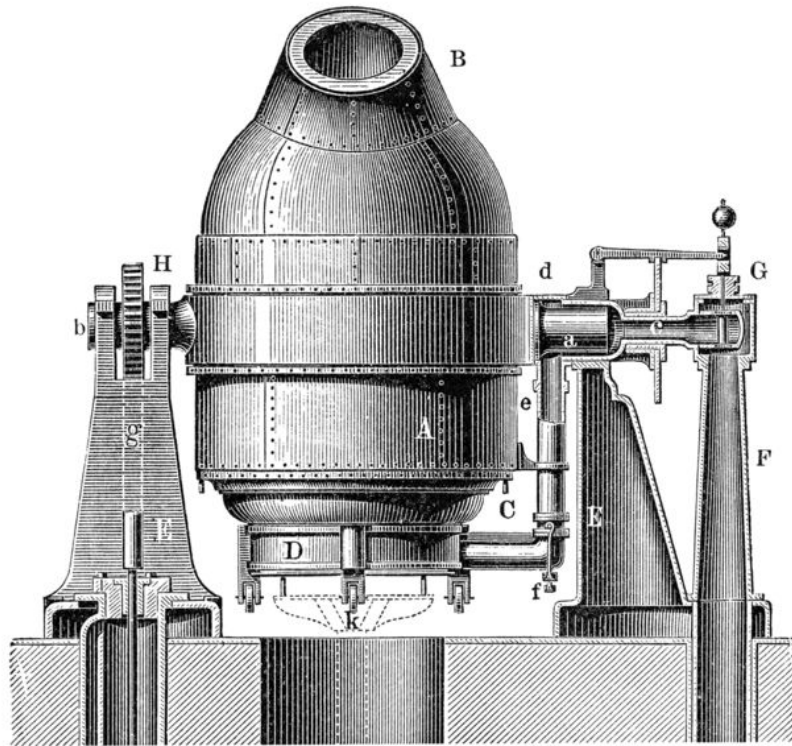

Figure 6.14: A Bessemer converter, used in making steel.

Oxford, and I shall get a thorough education, making the acquaintance of literary men... To continue much longer overwhelmed by business cares and with most of my thoughts wholly upon the way to make more money in the shortest time, must degrade me beyond hope of permanent recovery.”

When he sold his share of the United States Steel Corporation in 1901, Andrew Carnegie became one of the wealthiest men in the world. He devoted the remainder of his life to educational projects and to philanthropy. He established a large number of public libraries, not only in the United Kingdom and in the United States, but also in Canada, Ireland, Australia, New Zealand, the West Indies and Fiji. In all, Carnegie established 3,000 libraries. In addition, he founded the Carnegie Institution in Washington D.C. and the Carnegie Institute of Technology in Pittsburgh, which later became the Carnegie Mellon University.

In Scotland, his birthplace, where he lived for part of each year, Andrew Carnegie established a trust to assist in university education. In recognition of this generous gift (and perhaps also in recognition of his authorship of a number of books and articles), Andrew Carnegie was elected Lord Rector of the University of St. Andrews. Carnegie also gave a large amount of money to Booker T. Washington’s Tuskegee Institute. He established generous pension funds for his former employees, and also for American university professors. As if all this were not enough, he paid for the construction of 7,000 church organs,

contributed to the erection of the Peace Palace at the Hague, and established the Carnegie Foundation, which continues to perform good works, especially in the field of education.

In the lives of Cornelius Vanderbilt and Andrew Carnegie we see exemplified some of the features of the age in which they lived, when ruthless business behavior was often balanced by splendid acts of public generosity.

6.12 The conflict between capitalism and communism

The Russian Revolution

Industrialism in Russia started more slowly than in Europe and the United States. The emancipation of the serfs in 1861 by Czar Alexander II was incompletely carried out in practice, and Russia remained, to a large extent, in the grip of feudal absolutism. Dissatisfaction with the slowness of reform led to a series of protests. On January 22, 1905 (Bloody Sunday), a group of marchers in St. Petersburg brought a petition to the Winter Palace, hoping to hand it to the Czar. The petition called for improvement of working conditions, democratic elections, and establishment of a constituent assembly. Without the Tzar's knowledge (he was not in St. Petersburg at the time), government troops fired on the marchers, and about 1,000 were killed.

Between 1905 and 1908, strikes and peasant disorders occurred throughout Russia. The revolt of sailors on the Battleship Potemkin, upon which Sergei Eisenstein based his famous film, also occurred at this time.

In 1914, Russia entered the First World War on the side of England and France. The Russian troops were badly supplied, and suffered heavy casualties. With the soldiers absent from their fields, some of the larger Russian cities were threatened with famine.

By February, 1917, dissatisfaction had reached such a level that a total general strike occurred in St Petersburg. Instead of putting down this strike, weary Russian soldiers supported it, handing over their weapons to members of the angry crowds. These events lead to the abdication of Czar Nicholas II, who handed over power to the Kerensky Provisional Government. In October, 1917, the Bolsheviks under the leadership of V.I. Lenin, gained power. Lenin had been in exile in Switzerland before returning to lead the October Revolution, and he was a follower of the communist economist, Karl Marx.

The First Red Scare; McCarthyism; the Cold War

There were two distinct periods of violent anti-communism in the United States. The "First Red Scare" occurred between 1917 and 1920, while "McCarthyism" began in the late 1940's and lasted until the late 1950's.

The "First Red Scare" was largely inspired by the fear that the 1917 revolution in Russia would spread to the United States. In 1919, a bomb plot was uncovered; bombs were to be sent through the post to 36 prominent Americans, including John Pierpont Morgan, John D. Rockefeller and Supreme Court Justice Oliver Wendell Holmes. The year 1919 was also

characterized by hundreds of strikes throughout the United States. Newspapers described the strikes as communist plots, and the FBI arrested several thousand suspected agitators.

The McCarthy era occurred after World War II. The United States emerged from the war as the only major industrial power whose infrastructure had not been destroyed by the war. Thus the US found itself thrust somewhat reluctantly and nervously into a position of global leadership. Meanwhile a communist revolution had occurred in China, and this added to US nervousness, as did the Soviet development of nuclear weapons.

Senator Joseph McCarthy (1908-1957), and the House Un-American Activities Committee lead an aggressive populist hunt for communists and “communist sympathizers”. About 500 Hollywood actors, actresses and screenwriters were blacklisted.

The end of World War II also marked the start of the “Cold War” between capitalist and communist countries. The most dangerous feature of the Cold War was a nuclear arms race that resulted in a truly insane number of nuclear weapons. At the height of this arms race there were over 50,000 nuclear weapons in the world, with a total explosive power roughly a million times greater than the bomb that destroyed Hiroshima in 1945. Put another way, the bombs had an explosive power equivalent to 4 tons of TNT for every person on the planet. The world came close to thermonuclear war on several occasions, for example during the Cuban Missile Crisis of October, 1962. Although the Cold War has now ended, about 27,000 nuclear weapons still exist, many of them on hair-trigger alert. Because of the dangers of accidental nuclear war, nuclear proliferation and nuclear terrorism, these weapons continue to cast a very dark shadow over the future of humankind.

Capitalism triumphant

After the fall of the Berlin Wall in 1989, and the dissolution of the Soviet Union in 1991, capitalism spread to much of what had been the communist block of nations. Even China, although remaining officially a communist state, adopted capitalist methods on an experimental basis. Adam Smith, the prophet of the free market and of economic growth, was triumphant. We should notice that despite their differences regarding ownership of the means of production, capitalists and communists are united in their admiration of economic growth.

6.13 Globalization

In Chapter 3, we mentioned the exploitation of factory workers during the early phases of the Industrial Revolution. In the present chapter, we discussed how the growth of trade unions, the enactment of minimum wage laws, and laws preventing child labor, together with the gradual acceptance of birth control, led to a more widely-distributed prosperity, where workers shared the benefits of industrialization.

Today, economic globalization aims at increased trade throughout the world. At first sight, this seems to be a benefit. However, laws preventing the exploitation of labor are not universal. Workers in the developed countries can find themselves competing with grossly

underpaid labor in developing nations. The cure, of course, is to demand universal laws protecting workers from exploitation. Such laws must be a precondition for free trade.

6.14 Say's Law

Suburbia

The private automobile is the flagship of industrialism. In 2002, there were more than half a billion automobiles in the world. Of these, 140 million were in the United States (roughly one for every two people).

Reliance on private automobiles for transportation has affected the geography of cities, producing vast highway systems, urban sprawl and suburban life. For example, the Los Angeles metropolitan area spreads over 4,850 square miles (12,400 km²). Because of the availability of inexpensive motor fuel, public transportation is almost non-existent in Los Angeles. It is not uncommon for a citizen of the city to drive several hundred kilometers during a normal day. Many other cities in the world have a similar dependence on private automobiles.

A recent Canadian documentary film, *The End of Suburbia*, explores the history and probable future of cities built around the availability of inexpensive gasoline. The subtitle of the film is *Oil Depletion and the Collapse of the American Dream*.

Keeping up appearances

Of course, if we live in suburbia, we have to keep up with the neighbors. This is hard to do, because the neighbors keep getting new things - bigger automobiles, motorboats, swimming pools, and so on. Not only must we keep up with our actual neighbors, we must also compete with the glamorous lives that we see in films and television.

According to Say's Law, and according to advertisers and economists, human desires have no upper limit; there is no limit to growth. Television advertising and billboards constantly tell us that to be happy, or even respectable, we need to buy more. Thus mainstream industrial culture thunders ahead, worshiping power, material goods, wealth, growth and progress. There is, however, a counterculture, which we will look at in the next chapter.

6.15 Veblen; economics as anthropology

The phrase "conspicuous consumption" was invented by the Norwegian-American economist Thorstein Veblen (1857-1929) in order to describe the way in which our society uses economic waste as a symbol of social status. In *The Theory of the Leisure Class*, first published in 1899, Veblen pointed out that it is wrong to believe that human economic behavior is rational, or that it can be understood in terms of classical economic theory. To

understand it, Veblen maintained, one might preferably make use of insights gained from anthropology, psychology, sociology, and history.

Thorstein Veblen was born into a large Norwegian immigrant family living on a farm in Wisconsin. His first language was Norwegian, and in fact he did not learn English well until he was in his teens. He was a strange boy, precociously addicted to reading, but negligent about doing his chores on the farm. His family recognized that he was unusually intelligent and decided to send him to Carlton College, where he obtained a B.A. in 1880. Later he did graduate work at Johns Hopkins University and finally obtained a Ph.D. from Yale in 1884.

Despite the Ph.D., he failed to obtain an academic position. His iconoclastic views and non-conformist attitudes undoubtedly contributed to this joblessness. Returning to the family farm, Thorstein Veblen continued his voracious reading and his neglect of farm duties for six years. As one of his brothers wrote, "He was lucky enough to come out of a race and family who made family loyalty a religion... He was the only loafer in a highly respectable community... He read and loafed, and the next day he loafed and read."

An interesting fact about this strange man is that, for some reason, women found him very attractive. In 1888, Thorstein Veblen married Ellen Rolfe, the niece of the president of Carlton College. His wife was to leave him many times, partly because of his many infidelities, and partly because of his aloofness and detachment. He was like a visitor from another planet.

In part, the marriage to Ellen was motivated by Veblen's search for a job. He hoped to obtain work as an economist for the Atchison, Topeka and Santa Fe Railway, of which her uncle was president. However, the railway was in financial difficulties, and it was taken over by bankers, after which the position disappeared.

Finally a family council was held on the Veblen farm, and it was decided that Thorstein should once again attempt to enter the academic world. In 1891, wearing corduroy trousers and a coonskin hat, he walked into the office of the conservative economist J.L. Laughlan and introduced himself. Although taken aback by Veblen's appearance, Laughlan began to talk with him, and he soon recognized Veblen's genius. A year later, when he moved to the University of Chicago, Laughlan brought Veblen with him at a salary of \$520 per year.

At the University of Chicago, Veblen soon established a reputation both for eccentricity and for enormous erudition. His socks were held up by safety pins, but he was reputed to be fluent in twenty-six languages. He gained attention also by publishing a series of brilliant essays.

In 1899, Veblen "fluttered the doves of the East" by publishing a book entitled *The Theory of the Leisure Class*. It was part economics, part anthropology, and part social satire. Nothing of the kind had ever been seen in the field of economics. Until that moment it had been universally assumed that human economic behavior is rational. Veblen's detached and surgically sharp intelligence exposed it as being very largely irrational.

According to Thorstein Veblen, ancient tribal instincts and attitudes motivate us today, just as they motivated our primitive ancestors. Veblen speaks of a predatory phase of primitive society where the strongest fighters were able to subjugate others. This primitive class structure was based on violence, and, according to Veblen, the attitudes associated



Figure 6.15: Thorstein Veblen (1857-1929).

with it persist today.

For example, Veblen noted that male members of the leisure class liked to go about with walking sticks. Why? Because, answers Veblen, it is “an advertisement that the bearer’s hands are employed otherwise than in useful effort.” Also, a walking stick is a weapon: “The handling of so tangible and primitive a means of offense is very comforting to anyone who is gifted with even a moderate share of ferocity”.

Even in modern society, Veblen says, we have an admiration for those who succeed in obtaining power and money through predatory means, and this admiration makes honest and useful work seem degraded. “During the predatory culture”, Veblen wrote, “labour comes to be associated in men’s habits of thought with weakness and subjugation to a master. It is therefore a mark of inferiority, and therefore comes to be accounted to be unworthy of man in his best estate. By virtue of this tradition, labour is felt to be debasing, and this tradition has never died out. On the contrary, with the advance of social differentiation it has acquired the axiomatic force of ancient and unquestioned prescription.”

“In order to gain and hold the esteem of men it is not sufficient merely to possess wealth or power. The wealth or power must be put in evidence, for esteem is awarded only on evidence. It is felt by all persons of refined taste that a spiritual contamination is inseparable from certain offices that are conventionally required of servants. Vulgar surroundings, mean (that is to say, inexpensive) habitations, and vulgarly productive occupations are unhesitatingly condemned and avoided. They are incompatible with life on a satisfactory spiritual plane - with ‘high thinking’.”

“...The performance of labour has been accepted as a conventional evidence of inferior force, therefore it comes by itself, by a mental shortcut, to be regarded as intrinsically base.”

“The normal and characteristic occupations of the [leisure] class are... government, war, sports, and devout observances... At this as at any other cultural stage, government and war are, at least in part, carried out for the pecuniary gain of those who engage in them, but it is gain obtained by the honourable method of seizure and conversion.”

Veblen also remarks that “It is true of dress even in a higher degree than of most items of consumption, that people will undergo a very considerable degree of privation in the comforts or the necessities of life in order to afford what is considered a decent amount of wasteful consumption; so that it is by no means an uncommon occurrence, in an inclement climate, for people to go ill clad in order to appear well dressed.”

The sensation caused by the publication of Veblen’s book, and the fact that his phrase, “conspicuous consumption”, has become part of our language, indicate that his theory did not completely miss its mark. In fact, modern advertisers seem to be following Veblen’s advice: Realizing that much of the output of our economy will be used for the purpose of establishing the social status of consumers, advertising agencies hire psychologists to appeal to the consumer’s longing for a higher social position.

When possessions are used for the purpose of social competition, demand has no natural upper limit; it is then limited only by the size of the human ego, which, as we know, is boundless. This would be all to the good if unlimited economic growth were desirable. But today, when further growth implies future collapse, industrial society urgently needs

to find new values to replace our worship of power, our restless chase after excitement, and our admiration of excessive consumption.

6.16 Gandhi as an economist

If humans are to achieve a stable society in the distant future, it will be necessary for them to become modest in their economic behavior and peaceful in their politics. For both modesty and peace, Gandhi is useful as a source of ideas.

Mohandas Karamchand Gandhi was born in 1869 in Porbandar, India. His family belonged to the Hindu caste of shopkeepers. (In Gujarati “Gandhi” means “grocer”.) However, the family had risen in status, and Gandhi’s father, grandfather, and uncle had all served as prime ministers of small principalities in western India.

In 1888, Gandhi sailed for England, where he spent three years studying law at the Inner Temple in London. Before he left India, his mother had made him take a solemn oath not to touch women, wine, or meat. He thus came into contact with the English vegetarians, who included Sir Edward Arnold (translator of the Bhagavad Gita), the Theosophists Madame Blavatski and Annie Besant, and the Fabians. Contact with this idealistic group of social critics and experimenters helped to cure Gandhi of his painful shyness, and it also developed his taste for social reform and experimentation.

Gandhi’s exceptionally sweet and honest character won him many friends in England, and he encountered no racial prejudice at all. However, when he traveled to Pretoria in South Africa a few years later, he experienced racism in its worst form. Although he was meticulously well dressed in an English frock coat, and in possession of a first-class ticket, Gandhi was given the choice between traveling third class or being thrown off the train. (He chose the second alternative.) Later in the journey he was beaten by a coach driver because he insisted on his right to sit as a passenger rather than taking a humiliating position on the footboard of the coach.

The legal case which had brought Gandhi to South Africa was a dispute between a wealthy Indian merchant, Dada Abdullah Seth, and his relative, Seth Tyeb (who had refused to pay a debt of 40,000 pounds, in those days a huge sum). Gandhi succeeded in reconciling these two relatives, and he persuaded them to settle their differences out of court. Later he wrote about this experience:

“Both were happy with this result, and both rose in public estimation. My joy was boundless. I had learnt the true practice of law. I had learnt to find out the better side of human nature and to enter men’s hearts. I realized that the true function of a lawyer was to unite parties riven asunder. The lesson was so indelibly burnt into me that a large part of my time during my twenty years of practice as a lawyer was occupied in bringing about compromises of hundreds of cases. I lost nothing thereby - not even money, certainly not my soul.”

Gandhi was about to return to India after the settlement of the case, but at a farewell party given by Abdullah Seth, he learned of a bill before the legislature which would deprive Indians in South Africa of their right to vote. He decided to stay and fight against the bill.

Gandhi spent the next twenty years in South Africa, becoming the leader of a struggle for the civil rights of the Indian community. In this struggle he tried "...to find the better side of human nature and to enter men's hearts." Gandhi's stay in England had given him a glimpse of English liberalism and English faith in just laws. He felt confident that if the general public in England could be made aware of gross injustices in any part of the British Empire, reform would follow. He therefore organized non-violent protests in which the protesters sacrificed themselves so as to show as vividly as possible the injustice of an existing law. For example, when the government ruled that Hindu, Muslim and Parsi marriages had no legal standing, Gandhi and his followers voluntarily went to prison for ignoring the ruling.

Gandhi used two words to describe this form of protest: "satyagraha" (the force of truth) and "ahimsa" (non-violence). Of these he later wrote: "I have nothing new to teach the world. Truth and non-violence are as old as the hills. All that I have done is to try experiments in both on as vast a scale as I could. In so doing, I sometimes erred and learnt by my errors. Life and its problems have thus become to me so many experiments in the practice of truth and non-violence."

In his autobiography, Gandhi says: "Three moderns have left a deep impression on my life and captivated me: Raychandbhai (the Indian philosopher and poet) by his living contact; Tolstoy by his book 'The Kingdom of God is Within You'; and Ruskin by his book 'Unto This Last'."

Ruskin's book, "Unto This Last", which Gandhi read in 1904, is a criticism of modern industrial society. Ruskin believed that friendships and warm interpersonal relationships are a form of wealth that economists have failed to consider. He felt that warm human contacts are most easily achieved in small agricultural communities, and that therefore the modern tendency towards centralization and industrialization may be a step backward in terms of human happiness. While still in South Africa, Gandhi founded two religious Utopian communities based on the ideas of Tolstoy and Ruskin. Phoenix Farm (1904) and Tolstoy Farm (1910). At this time he also took an oath of chastity ("bramacharya"), partly because his wife was unwell and he wished to protect her from further pregnancies, and partly in order to devote himself more completely to the struggle for civil rights.

Because of his growing fame as the leader of the Indian civil rights movement in South Africa, Gandhi was persuaded to return to India in 1914 and to take up the cause of Indian home rule. In order to reacquaint himself with conditions in India, he traveled tirelessly, now always going third class as a matter of principle.

During the next few years, Gandhi worked to reshape the Congress Party into an organization which represented not only India's Anglicized upper middle class but also the millions of uneducated villagers who were suffering under an almost intolerable burden of poverty and disease. In order to identify himself with the poorest of India's people, Gandhi began to wear only a white loincloth made of rough homespun cotton. He traveled to the remotest villages, recruiting new members for the Congress Party, preaching non-violence and "firmness in the truth", and becoming known for his voluntary poverty and humility. The villagers who flocked to see him began to call him "Mahatma" (Great Soul).

Disturbed by the spectacle of unemployment and poverty in the villages, Gandhi urged



Figure 6.16: **Gandhi and his wife Kasturbhai in 1902.**

the people of India to stop buying imported goods, especially cloth, and to make their own. He advocated the reintroduction of the spinning wheel into village life, and he often spent some hours spinning himself. The spinning wheel became a symbol of the Indian independence movement, and was later incorporated into the Indian flag.

The movement for boycotting British goods was called the “Swadeshi movement”. The word Swadeshi derives from two Sanskrit roots: *Swa*, meaning self, and *Desh*, meaning country. Gandhi described Swadeshi as “a call to the consumer to be aware of the violence he is causing by supporting those industries that result in poverty, harm to the workers and to humans or other creatures.”

Gandhi tried to reconstruct the crafts and self-reliance of village life that he felt had been destroyed by the colonial system. “I would say that if the village perishes India will perish too”, he wrote, “India will be no more India. Her own mission in the world will get lost. The revival of the village is only possible when it is no more exploited. Industrialization on a mass scale will necessarily lead to passive or active exploitation of the villagers as problems of competition and marketing come in. Therefore we have to concentrate on the village being self-contained, manufacturing mainly for use. Provided this character of the village industry is maintained, there would be no objection to villagers using even the modern machines that they can make and can afford to use. Only they should not be used as a means of exploitation by others.”

“You cannot build nonviolence on a factory civilization, but it can be built on self-contained villages... Rural economy as I have conceived it, eschews exploitation altogether, and exploitation is the essence of violence... We have to make a choice between India of the villages that are as ancient as herself and India of the cities which are a creation of foreign domination...”

“Machinery has its place; it has come to stay. But it must not be allowed to displace

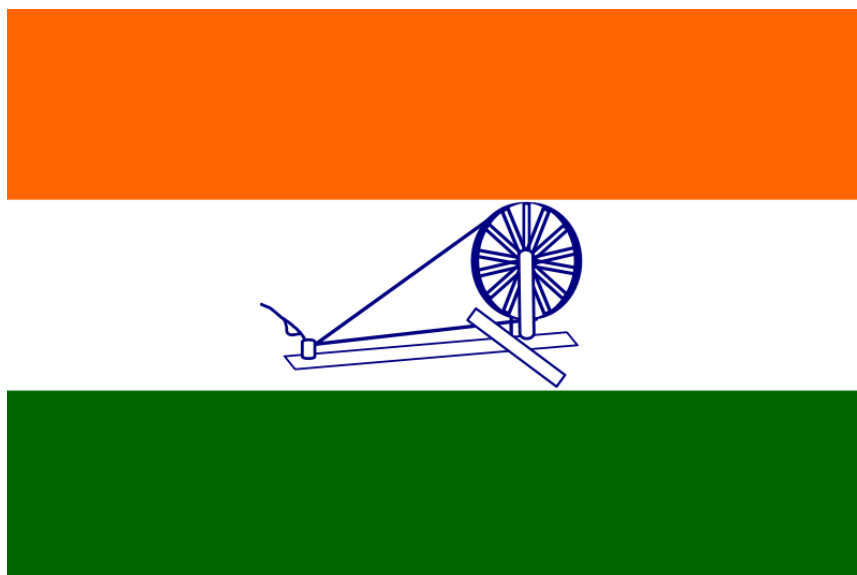

Figure 6.17: **Gandhi's spinning wheel was incorporated into the flag of the Congress Party and later into the national flag of an independent India.**

necessary human labour. An improved plow is a good thing. But if by some chances, one man could plow up, by some mechanical invention of his, the whole of the land of India, and control all the agricultural produce, and if the millions had no other occupation, they would starve, and being idle, they would become dunces, as many have already become. There is hourly danger of many being reduced to that unenviable state.”

In these passages we see Gandhi not merely as a pioneer of nonviolence; we see him also as an economist. Faced with misery and unemployment produced by machines, Gandhi tells us that social goals must take precedence over blind market mechanisms. If machines are causing unemployment, we can, if we wish, and use labor-intensive methods instead. With Gandhi, the free market is not sacred - we can do as we wish, and maximize human happiness, rather than maximizing production and profits.

Gandhi also organized many demonstrations whose purpose was to show the British public that although the British raj gave India many benefits, the toll exacted was too high, not only in terms of money, but also in terms of India's self-respect and self-sufficiency. All of Gandhi's demonstrations were designed to underline this fact. For example, in 1930 Gandhi organized a civil-disobedience campaign against the salt laws. The salt laws gave the Imperial government a monopoly and prevented Indians from making their own salt by evaporating sea water. The majority of Indians were poor farmers who worked long hours in extreme heat, and salt was as much a necessity to them as bread. The tax on salt was essentially a tax on the sweat of the farmers.

Before launching his campaign, Gandhi sent a polite letter to the Viceroy, Lord Irwin, explaining his reasons for believing that the salt laws were unjust, and announcing his intention of disregarding them unless they were repealed. Then, on March 12 1930, Gandhi

and many of his followers, accompanied by several press correspondents, started on a march to the sea to carry out their intention of turning themselves into criminals by making salt. Every day, Gandhi led the procession about 12 miles, stopping at villages in the evenings to hold prayer meetings. Many of the villagers joined the march, while others cast flower petals in Gandhi's path or sprinkled water on his path to settle the dust.

On April 5 the marchers arrived at the sea, where they spent the night in prayer on the beach. In the morning they began to make salt by wading into the sea, filling pans with water, and letting it evaporate in the sun. Not much salt was made in this way, but Gandhi's action had a strong symbolic power. A wave of non-violent civil disobedience demonstrations swept over India, so extensive and widespread that the Imperial government, in danger of losing control of the country, decided to arrest as many of the demonstrators as possible. By midsummer, Gandhi and a hundred thousand of his followers were in prison, but nevertheless the civil disobedience demonstrations continued.

In January, 1931, Gandhi was released from prison and invited to the Viceroy's palace to talk with Lord Irwin. They reached a compromise agreement: Gandhi was to call off the demonstrations and would attend a Round Table Conference in London to discuss Indian home rule, while Lord Irwin agreed to release the prisoners and would change the salt laws so that Indians living near to the coast could make their own salt.

The salt march was typical of Gandhi's non-violent methods. Throughout the demonstrations he tried to maintain a friendly attitude towards his opponents, avoiding escalation of the conflict. Thus at the end of the demonstrations, the atmosphere was one in which a fair compromise solution could be reached. Whenever he was in prison, Gandhi regarded his jailers as his hosts. Once, when he was imprisoned in South Africa, he used the time to make a pair of sandals, which he sent to General Smuts, the leader of the South African government. Thus Gandhi put into practice the Christian principle, "Love your enemies; do good to them that hate you."

Gandhi's importance lies in the fact that he was a major political leader who sincerely tried to put into practice the ethical principles of religion. In his autobiography Gandhi says: "I can say without the slightest hesitation, and yet with all humility, that those who say that religion has nothing to do with politics do not know what religion means."

Gandhi believed that human nature is essentially good, and that it is our task to find and encourage whatever is good in the character of others. During the period when he practiced as a lawyer, Gandhi's aim was "to unite parties riven asunder," and this was also his aim as a politician. In order for reconciliation to be possible in politics, it is necessary to avoid escalation of conflicts. Therefore Gandhi used non-violent methods, relying only on the force of truth. "It is my firm conviction," he wrote, "that nothing can be built on violence."

To the insidious argument that "the end justifies the means," Gandhi answered firmly: "They say 'means are after all means'. I would say 'means are after all everything'. As the means, so the end. Indeed the Creator has given us control (and that very limited) over means, none over end. ... The means may be likened to a seed, and the end to a tree; and there is the same inviolable connection between the means and the end as there is between the seed and the tree. Means and end are convertible terms in my philosophy of

life.” In other words, a dirty method produces a dirty result; killing produces more killing; hate leads to more hate. But there are positive feedback loops as well as negative ones. A kind act produces a kind response; a generous gesture is returned; hospitality results in reflected hospitality. Hindus and Buddhists call this principle “the law of karma”.

Gandhi believed that the use of violent means must inevitably contaminate the end achieved. Because Gandhi’s methods were based on love, understanding, forgiveness and reconciliation, the non-violent revolution which he led left very little enmity in its wake. When India finally achieved its independence from England, the two countries parted company without excessive bitterness. India retained many of the good ideas which the English had brought - for example the tradition of parliamentary democracy - and the two countries continued to have close cultural and economic ties.

Mahatma Gandhi was assassinated by a Hindu extremist on January 30, 1948. After his death, someone collected and photographed all his worldly goods. These consisted of a pair of glasses, a pair of sandals and a white homespun loincloth. Here, as in the Swadeshi movement, we see Gandhi as a pioneer of economics. He deliberately reduced his possessions to an absolute minimum in order to demonstrate that there is no connection between personal merit and material goods. Like Veblen, Mahatma Gandhi told us that we must stop using material goods as a means of social competition. We must start to judge people not by what they have, but by what they are.

6.17 Thoreau

In the distant future (and perhaps even in the not-so-distant future) industrial civilization will need to abandon its relentless pursuit of unnecessary material goods and economic growth. Modern society will need to re-establish a balanced and harmonious relationship with nature. In pre-industrial societies harmony with nature is usually a part of the cultural tradition. In our own time, the same principle has become central to the ecological counter-culture while the main-stream culture thunders blindly ahead, addicted to wealth, power and growth.

In the 19th century the American writer, Henry David Thoreau (1817-1862), pioneered the concept of a simple life, in harmony with nature. Today, his classic book, *Walden*, has become a symbol for the principles of ecology, simplicity, and respect for nature.

Thoreau was born in Concord Massachusetts, and he attended Harvard from 1833 to 1837. After graduation, he returned home, worked in his family’s pencil factory, did odd jobs, and for three years taught in a progressive school founded by himself and his older brother, John. When John died of lockjaw in 1842, Henry David was so saddened that he felt unable to continue the school alone.

Thoreau refused to pay his poll tax because of his opposition to the Mexican War and to the institution of slavery. Because of his refusal to pay the tax (which was in fact a very small amount) he spent a night in prison. To Thoreau’s irritation, his family paid the poll tax for him and he was released. He then wrote down his ideas on the subject in an essay entitled *The Duty of Civil Disobedience*, where he maintains that each person has a

duty to follow his own individual conscience even when it conflicts with the orders of his government. "Under a government that which imprisons any unjustly", Thoreau wrote, "the true place for a just man is in prison." *Civil Disobedience* influenced Tolstoy, Gandhi and Martin Luther King, and it anticipated the Nüremberg Principles.

Thoreau became the friend and companion of the transcendentalist writer Ralph Waldo Emerson (1803-1882), who introduced him to a circle of writers and thinkers that included Ellery Channing, Margaret Fuller and Nathaniel Hawthorne.

Nathaniel Hawthorne described Thoreau in the following words: "Mr. Thorow [sic] is a keen and delicate observer of nature - a genuine observer, which, I suspect, is almost as rare a character as even an original poet; and Nature, in return for his love, seems to adopt him as her especial child, and shows him secrets which few others are allowed to witness. He is familiar with beast, fish, fowl, and reptile, and has strange stories to tell of adventures, and friendly passages with these lower brethren of mortality. Herb and flower, likewise, wherever they grow, whether in garden, or wild wood, are his familiar friends. He is also on intimate terms with the clouds and can tell the portents of storms. It is a characteristic trait, that he has a great regard for the memory of the Indian tribes, whose wild life would have suited him so well; and strange to say, he seldom walks over a plowed field without picking up an arrow-point, a spear-head, or other relic of the red men - as if their spirits willed him to be the inheritor of their simple wealth."

At Emerson's suggestion, Thoreau opened a journal, in which he recorded his observations concerning nature and his other thoughts. Ultimately the journal contained more than 2 million words. Thoreau drew on his journal when writing his books and essays, and in recent years, many previously unpublished parts of his journal have been printed.

From 1845 until 1847, Thoreau lived in a tiny cabin that he built with his own hands. The cabin was in a second-growth forest beside Walden Pond in Concord, on land that belonged to Emerson. Thoreau regarded his life there as an experiment in simple living. He described his life in the forest and his reasons for being there in his book *Walden*, which was published in 1854. The book is arranged according to seasons, so that the two-year sojourn appears compressed into a single year.

"Most of the luxuries", Thoreau wrote, "and many of the so-called comforts of life, are not only not indispensable, but positive hindrances to the elevation of mankind. With respect to luxuries, the wisest have ever lived a more simple and meager life than the poor. The ancient philosophers, Chinese, Hindoo, Persian, and Greek, were a class than which none has been poorer in outward riches, none so rich in inward."

Elsewhere in *Walden*, Thoreau remarks, "It is never too late to give up your prejudices", and he also says, "Why should we be in such desperate haste to succeed, and in such desperate enterprises? If a man does not keep pace with his companions, perhaps it is because he hears a different drummer." Other favorite quotations from Thoreau include "Rather than love, than money, than fame, give me truth", "Beware of all enterprises that require new clothes", "Most men lead lives of quiet desperation" and "Men have become tools of their tools."

Towards the end of his life, when he was very ill, someone asked Thoreau whether he had made his peace with God. "We never quarreled", he answered.



Figure 6.18: Henry David Thoreau, 1817-1862.

Thoreau's closeness to nature can be seen from the following passage, written by his friend Frederick Willis, who visited him at Walden Pond in 1847, together with the Alcott family: "He was talking to Mr. Alcott of the wild flowers in Walden woods when, suddenly stopping, he said: 'Keep very still and I will show you my family.' Stepping quickly outside the cabin door, he gave a low and curious whistle; immediately a woodchuck came running towards him from a nearby burrow. With varying note, yet still low and strange, a pair of gray squirrels were summoned and approached him fearlessly. With still another note several birds, including two crows flew towards him, one of the crows nestling upon his shoulder. I remember that it was the crow resting close to his head that made the most vivid impression on me, knowing how fearful of man this bird is. He fed them all from his hand, taking food from his pocket, and petted them gently before our delighted gaze; and then dismissed them by different whistling, always strange and low and short, each wild thing departing instantly at hearing his special signal."

In an essay published by the *Atlantic Monthly* in 1853, Thoreau described a pine tree in Maine with the words: "It is as immortal as I am, and perchance will go to as high a heaven, there to tower above me still." However, the editor (James Russell Lowell) considered the sentence to be blasphemous, and removed it from Thoreau's essay before publication.

In one of his essays, Thoreau wrote: "If a man walk in the woods for love of them half of each day, he is in danger of being regarded as a loafer; but if he spends his whole day as a speculator, shearing off those woods and making the earth bald before her time, he is esteemed an industrious and enterprising citizen."

6.18 The counter-culture

Say's Law asserts that "Supply creates its own demand". Jean-Baptiste Say's basis for this proposition was the assumption that a consumer's desire for goods is infinite. He combined this assumption with the observation that the wages paid for the production of goods will provide money enough to buy back the goods, even if the amount involved increases without limit. Comforted by Say's "law", and by the observation that people in industrial societies do indeed consume far more than they actually need, economists continue to pursue economic growth as though it were the Holy Grail. We do indeed devote much of our efforts to "making the earth bald before her time".

As things are today, the advertising industry, which is part of the mainstream culture, whips demand towards ever higher levels by exploiting our tendency to use material goods for the purpose of social competition. Meanwhile, a small but significant counter-culture has realized that unlimited economic growth will lead to ecological disaster unless we stop in time.

In the 1960's, a counter-culture developed in the United States, partly as a reaction against the Vietnam War and partly as a reaction against consumerism. It seemed to young people that they were being offered a possession-centered way of life that they did not want, and that they were being asked to participate in a war that they thought was immoral.

In 1964, a free speech movement began on the campus of the University of California in Berkeley. Students demanded that the university administration should lift a ban that it had imposed on on-campus political activities. Student movements elsewhere in the United States and in Europe echoed the Berkeley protests throughout the late 1960's and early 1970's.

Mario Savo, one of the leaders of the Berkeley free speech movement, compared the Establishment to an enormous anti-human machine: "There is a time when the operation of the machine becomes so odious, makes you so sick at heart, that you can't take part; you can't even passively take part, and you've got to put your bodies upon the gears and upon the wheels, upon the levers, upon all the apparatus, and you've got to make it stop. And you've got to indicate to the people who run it, to the people who own it, that unless you're free, the machine will be prevented from working at all."

The Greening of America, by Charles Reich, describes the youth-centered counter-culture: "Industrialism produced a new man...", Reich wrote, "one adapted to the demands of the machine. In contrast, today's emerging consciousness seeks a new knowledge of what it means to be human, in order that the machine, having been built, may now be turned to human ends; in order that man once more can become a creative force, renewing and creating his own life and thus giving life back to society."

6.19 The Brundtland Report

In 1972, the United Nations Conference on the Human Environment took place in Stockholm. In a 1983 follow-up to the Stockholm conference, the General Assembly of the UN adopted a resolution (A/38/161) establishing the World Commission on Environment and Development. It is usually known as the Brundtland Commission after the name of its Chair, Dr. Gro Harlem Brundtland, who was at the time the Prime Minister of Norway. The report of the Brundtland Commission, entitled *Our Common Future*, was submitted to the United Nations in 1987.

In the words of Dr. Brundtland, the goal of the report was "to help define shared perceptions of long-term environmental issues and the appropriate efforts needed to deal successfully with the problems of protecting and enhancing the environment, a long-term agenda for action during the coming decades..."

One of the key concepts of the Brundtland Report was "sustainable development". The Report offered the following definition: "Sustainable development is development that meets the needs of the present without compromising the ability of future generations to meet their own needs."

The Brundtland Commission's key concepts for sustainability were as follows:

1. Today's needs should not compromise the ability of future generations to meet their needs.
2. A direct link exists between the economy and the environment.



Figure 6.19: **Gro Harlem Brundtland**

3. The needs of the poor in all nations must be met.
4. In order for the environment to be protected, the economic conditions of the world's poor must be improved.
5. In all our actions, we must consider the impact upon future generations.

The Brundtland Commission's report examines the question of whether the earth can support a population of 10 billion people without the collapse of the ecological systems on which all life depends. The report states that the data "suggest that meeting the food requirements of an ultimate world population of around 10 billion would require some changes in food habits, as well as greatly improving the efficiency of traditional agriculture."

6.20 The Earth Summit at Rio

The Brundtland Report served as a preparation for the United Nations Conference on Environment and Development, which took place from the 3rd to the 14th of June, 1992 in Rio de Janeiro. The conference, informally called the "Earth Summit", was unprecedented in its size and significance. 172 governments participated, including 108 heads of state or government. 17,000 people attended the Earth Summit, including 2,400 representatives of NGO's. An estimated 10,000 journalists covered the conference.

The Earth Summit at Rio ought to have been a turning point in the relationship between humans and the global environment. However, despite the size and importance of the conference, and despite the hopes of most of the participants, the the Earth Summit did not result in the changes in laws and lifestyles that will be needed to establish long-term sustainability.

Two basic problems are leading to the destruction of the global environment - excessive population growth in the developing South, and excessive economic growth and overconsumption in the industrial North. Political and religious pressures prevented overpopulation from being named at Rio as one of the root causes of environmental degradation. Political pressures also prevented the necessary changes in laws and lifestyles from being made in the North.

Nevertheless, considerable progress was made at Rio. The resulting documents included Agenda 21 (an environmental agenda for the 21st century), the Rio Declaration on Environment and Development, the Statement on Forest Principles, the United Nations Framework Convention on Climate Change and the United Nations Convention on Biological Diversity. Later the Earth Charter was developed by some of the leaders who met in Rio.

Agenda 21

The first few chapters of Agenda 21 are as follows:

1. Preamble
2. International cooperation to accelerate sustainable development in developing countries and related domestic policies
3. Combating poverty
4. Changing consumption patterns
5. Demographic dynamics and sustainability
6. Protecting and promoting human health conditions
7. Promoting sustainable human settlement development
8. Integrating environment and development in decision-making
9. Protecting the atmosphere
10. Integrated approach to the planning and management of land resources
11. Combating deforestation
12. Managing fragile ecosystems; sustainable mountain development
13. Conservation of biological diversity
14. Environmentally sound management of biotechnology
15. Protection of the oceans

The good intentions of the authors shine from this list! It was a major victory to have Agenda 21 adopted as the official policy of the United Nations. Close examination reveals many political compromises in the wording the conclusions, but the idealism of the document is not entirely lost.

Agenda 21, touches (very lightly!) on the root causes of environmental degradation. In Section 4.6, one finds the extremely weak statement: "Some economists are questioning traditional concepts of economic growth and underlining the importance of pursuing economic objectives that take into account of the full value of natural resource capital. More needs to be known about the role of consumption in relation to economic growth and population dynamics in order to formulate coherent international and national policies." However, in Section 5.3, a clearer statement of the basic problem appears: "The growth of world population and production, combined with unsustainable consumption patterns, places increasingly severe stress on the life-supporting systems of our planet."

6.21 The transition from growth to a steady state - minimizing the trauma

According to Adam Smith, the free market is the dynamo of economic growth. The true entrepreneur does not indulge in luxuries for himself and his family, but reinvests his profits, with the result that his business or factory grows larger, producing still more profits, which he again reinvests, and so on. This is indeed the formula for exponential economic growth.

Economists (with a few notable exceptions) have long behaved as though growth were synonymous with economic health. If the gross national product of a country increases steadily by 4% per year, most economists express approval and say that the economy is healthy. If the economy could be made to grow still faster (they maintain), it would be still more healthy. If the growth rate should fall, economic illness would be diagnosed. However, the basic idea of Malthus is applicable to exponential increase of any kind. It is obvious that on a finite Earth, neither population growth nor economic growth can continue indefinitely.

A "healthy" economic growth rate of 4% per year corresponds to an increase by a factor of 50 in a century, by a factor of 2500 in two centuries, and by a factor of 125,000 in three centuries. No one can maintain that this type of growth is sustainable except by refusing to look more than a short distance into the future.

But *why* do most economists cling so stubbornly and blindly to the concept of growth? Why do they refuse to look more than a few years into the future? We can perhaps understand this strange self-imposed myopia by remembering some of David Ricardo's ideas: One of his most important contributions to economic theory was his analysis of rents. Ricardo considered the effects of economic expansion; and he concluded that as population increased, marginally fertile land would be forced into cultivation. The price of grain would be determined by the cost of growing it on inferior land; and the owners of better land would be able to pocket a progressively larger profit as worse and worse land

was forced into use by the demands of a growing population. Ricardo's analysis of rents for agricultural land has various generalizations; for example, a growing population also puts pressure on land used for building cities, and profits can be gained by holding such land, or through the ownership of houses in growing cities. In general, in a growing economy, investments are likely to be rewarded. In a stationary or contracting economy, the stock market may crash.

Considerations like those just discussed make it easy to understand why economists are biased in favor of growth. However, we are now entering a period where biological and physical constraints will soon put an end to economic growth.

Instead of burning our tropical forests, it might be wise for us to burn our books on growth-oriented economics! An entirely new form of economics is needed today - not the empty-world economics of Adam Smith, but what might be called "full-world economics", or "steady-state economics".

The present use of resources by the industrialized countries is extremely wasteful. A growing national economy must, at some point, exceed the real needs of the citizens. It has been the habit of the developed countries to create artificial needs by means of advertising, in order to allow economies to grow beyond the point where all real needs have been met; but this extra growth is wasteful, and in the future it will be important not to waste the earth's diminishing supply of non-renewable resources.

Thus, the times in which we live present a challenge: We need a revolution in economic thought. We must develop a new form of economics, taking into account the realities of the world's present situation - an economics based on real needs and on a sustainable equilibrium with the environment, not on the thoughtless assumption that growth can continue forever.

Adam Smith was perfectly correct in saying that the free market is the dynamo of economic growth; but exponential growth of human population and economic activity have brought us, in a surprisingly short time, from the empty-world situation in which he lived to a full-world situation. In today's world, we are pressing against the absolute limits of the earth's carrying capacity, and further growth carries with it the danger of future collapse. Full-world economics, the economics of the future, will no longer be able to rely on growth to give profits to stockbrokers or to solve problems of unemployment or to alleviate poverty. In the long run, growth of any kind is not sustainable; and we are now nearing its sustainable limits.

Like a speeding bus headed for a brick wall, the earth's rapidly-growing population of humans and its rapidly-growing economic activity are headed for a collision with a very solid barrier - the carrying capacity of the global environment. As in the case of the bus and the wall, the correct response to the situation is to apply the brakes in time - but fear prevents us from doing this. What will happen if we slow down very suddenly? Will not many of the passengers be injured? Undoubtedly. But what will happen if we hit the wall at full speed? Perhaps it would be wise, after all, to apply the brakes!

The memory of the great depression of 1929 makes us fear the consequences of an economic slowdown, especially since unemployment is already a serious problem in many parts of the world. Although the history of the 1929 depression is frightening, it may

nevertheless be useful to look at the measures which were used then to bring the global economy back to its feet. A similar level of governmental responsibility may help us to avoid some of the more painful consequences of the necessary transition from the economics of growth to steady-state economics.

In the United States, President Franklin D. Roosevelt was faced with the difficult problems of the depression during his first few years in office. Roosevelt introduced a number of special governmental programs, such as the WPA, the Civilian Construction Corps and the Tennessee Valley Authority, which were designed to create new jobs on projects directed towards socially useful goals - building highways, airfields, auditoriums, harbors, housing projects, schools and dams. The English economist John Maynard Keynes, (1883-1946), provided an analysis of the factors that had caused the 1929 depression, and a theoretical justification of Roosevelt's policies.

The transition to a sustainable global society will require a similar level of governmental responsibility, although the measures needed are not the same as those which Roosevelt used to end the great depression. Despite the burst of faith in the free market which has followed the end of the Cold War, it seems unlikely that market mechanisms alone will be sufficient to solve problems of unemployment in the long-range future, or to achieve conservation of land, natural resources and environment.



Figure 6.20: Franklin D. Roosevelt (1882-1945) with his dog Fala and Ruthie Bie at Hilltop in 1941. Roosevelt served as President of the United States from 1933 to 1945, and was starting his 4th term when he died. Although crippled by polio, he managed to convey an image of dynamism and confidence.

6.22 Keynesian economics

In December, 1933, Keynes wrote to Franklin D. Roosevelt: “Dear Mr. President, You have made yourself the Trustee for those in every country who seek to mend the evils of our condition by reasoned experiment within the framework of the existing social system. If you fail, rational change will be gravely prejudiced throughout the world, leaving orthodoxy and revolution to fight it out. But if you succeed, new and bolder methods will be tried everywhere, and we may date the first chapter of a new economic era from your accession to office...”

“...Thus as the prime mover in the first stage of the technique of recovery I lay overwhelming emphasis on the increase of national purchasing power resulting from governmental expenditure which is financed by Loans and not by taxing present incomes. Nothing else counts in comparison with this. In a boom inflation can be caused by allowing unlimited credit to support the excited enthusiasm of business speculators. But in a slump governmental Loan expenditure is the only sure means of securing quickly a rising output at rising prices. That is why war has always caused intense industrial activity. In the past orthodox finance has regarded war as the only legitimate excuse for creating employment by governmental expenditure. You, Mr. President, having cast off such fetters, are free to engage in the interests of peace and prosperity the technique which hitherto has only been allowed to serve the purposes of war and destruction.”

John Maynard Keynes (1883-1946), the author of this letter to Roosevelt, was the son of the Cambridge University economist and logician, Neville Keynes. After graduating from Eton and studying economics at King’s College, Cambridge, Keynes spent a few years as a civil servant in the India Office. In 1909, he returned to Cambridge as a Fellow of King’s College. He became a member of the “Bloomsbury Group”, a collection of intellectual friends that included Virginia and Leonard Woolf, E.M. Forster, Clive and Vanessa Bell, Duncan Grant, Lytton Strachy, Roger Fry, and Bertrand Russell. In 1911, Keynes became the editor of the *Economic Journal*, a position that he retained almost until the end of his life.

In 1918, Keynes married the Russian ballerina Lydia Lopokova. They met at a party given by the Sitwells. Lydia was struggling to learn English, and one of her more interesting remarks was, “I dislike being in the country in August because my legs get so bitten by barristers”. To everyone’s surprise, Lydia proved to be the perfect wife for Keynes, encouraging his wide range of cultural interests. He and Lydia did much to develop the Cambridge Arts Theatre. Lydia maintained her interest in the ballet, although she no longer danced professionally. Visitors to the couple’s house occasionally heard formidable thumpings from an upper room, and they realized that Lydia was practicing.

During World War I, Keynes worked in the British Treasury, helping to find ways to finance the war. In 1919, he was sent to the peace conference at Versailles as a representative of the Treasury. Keynes recognized the disastrous economic consequences that would follow from the Treaty of Versailles, and returning to Cambridge, he wrote *The Economic Consequences of the Peace* (1919). “It is an extraordinary fact”, Keynes wrote, “that the fundamental problems of a Europe starving and disintegrating before their eyes, was the



Figure 6.21: John Maynard Keynes (right) with Harry Dexter White at the Bretton Woods Conference. Keynes was an extremely tall man - 6 feet and 6 inches tall, i.e. 198 cm. Heart problems caused his early death.

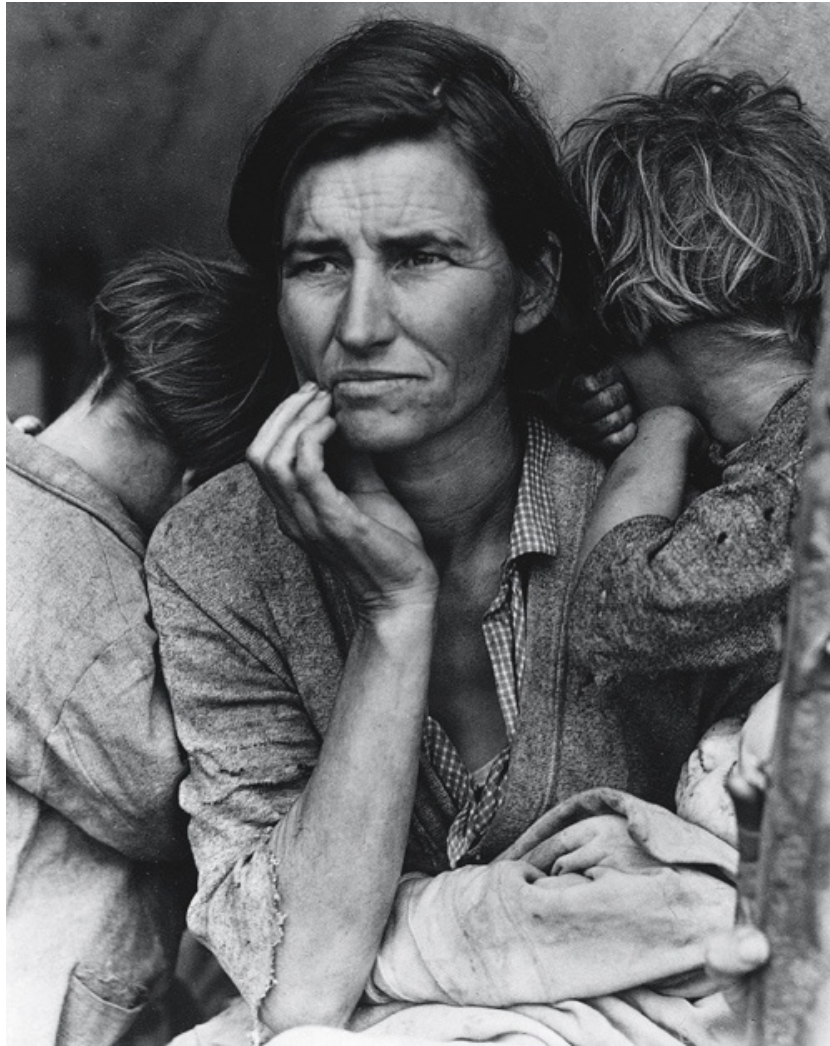

Figure 6.22: **Migrant Mother**, a photograph by Dorothea Lange, shows a destitute pea picker in California in 1936, during the Great Depression.

one question in which it was impossible to arouse the interest of the [Council of] Four.”

The book became a best seller and was very influential in shaping public opinion, both in England and in the United States. In his book, Keynes predicted that the reparations imposed against Germany at Versailles would cause economic ruin. He advocated instead a loan system to rebuild postwar Europe. The plan advocated by Keynes was similar to the Marshall Plan that followed World War II. Had it been put into effect in 1919, it might have prevented the Second World War.

In 1936, Keynes published his magnum opus, *General Theory of Employment, Interest and Money*. In this book, he provided a theoretical explanation for the fact that the great depression showed no tendency to right itself, as well as arguments for governmental interventions to counter business cycles and to produce full employment. Once again, Keynes

had written a best-seller. His *General Theory* proved to be one of the most influential books on economics ever written.

Keynes rebelled against the ideas of the classical economists, who believed that if let entirely alone, the world economy would correct itself. The classical economists recommended that, to end the depression, labor unions should be made illegal, minimum wages and long-term wage contracts abolished, and government spending curtailed (to restore business confidence). Then, they maintained, wages would fall, businessmen would hire more workers, and full employment and production would be restored. One reason for the popularity of the *General Theory* was that everyone knew the recommendations of the classical economists were bad policies. Now Keynes showed why these bad policies were also bad economics.

Keynes pointed out that a fall in wages would produce a fall in purchasing power, and hence a fall in aggregate demand. Producers would then be less able to sell their products. Thus Keynes believed that falling wages would deepen the depression, rather than ending it.

Part of Keynes' skepticism towards classical economics had to do with his criticisms of the short-term version of Say's Law, on which classical economics was based. Jean-Baptiste Say (1767-1832) believed a general glut to be impossible, since wages for the production of goods could be used by society to buy back its aggregate production. "A glut", Say wrote, "can take place only when there are too many means of production applied to one kind of product, and not enough to another."

Say considered the influence of the money supply on this process to be negligible, and he believed that the problem could be analyzed from the standpoint of barter. Say believed that no one would keep money for long. Having obtained money in a transaction, he believed, people would immediately spend it again. Thus Say did not worry about the problem of excessive saving that bothered both Malthus and Hobson.

"It is not the abundance of money", Say wrote, "but the abundance of other products in general that facilitates sales... Money performs no more than the role of a conduit in this double exchange. When the exchanges have been completed, it will be found that one has paid for products with products."

"It is worthwhile to remark", Say continued, "that a product is no sooner created than it, from that instant, affords a market for other products to the full extent of its value. When the producer has put the finishing hand to his product, he is most anxious to sell it immediately, lest its value should diminish in his hands. Nor is he less anxious to dispose of the money he may get for it; for the value of money is also perishable. But the only way to get rid of money is in the purchase some product or other. Thus the mere circumstance of creation of one product immediately opens a vent for other products."

Keynes disagreed with these conclusions in several respects. First of all, he did not believe, like Say, that the money supply played a negligible role in determining economic activity. Secondly he did not agree that the producer who has received money for his goods is necessarily "anxious to dispose of the money". As a recession deepens, the value of money in terms of goods increases, and therefore it is rational to keep money, hoping to get more goods for it at a later time. Whether it is more rational to keep money or to

spend it immediately depends on the phase of the business cycle, Keynes pointed out.

In James Mill's version, Say's Law states that "supply creates its own demand". Keynes reversed this, and maintained in a depression, the fault may be on the demand side, i.e., "demand creates supply", rather than the reverse. It is true that during the great depression, many people were in need; but need does not constitute demand in the economic sense unless it is combined with purchasing power.

Keynes (like Malthus and Hobson) believed that excessive saving could be a serious problem, capable of causing a "general glut" or depression. By excessive saving, he meant saving beyond planned investment, a condition that could be caused by falling consumer demand, overinvestment in previous years, or lack of business confidence. The classical economists believed that excessive saving would be corrected by falling interest rates. Keynes did not believe that interest rates would respond quickly enough to perform this corrective function. Instead, Keynes believed, excessive savings would be in the end corrected by the fall in aggregate income which characterizes a recession or depression. The economy would reach a new equilibrium at low levels of employment, income, investment and production. This new, undesirable equilibrium would not be self-correcting. (By calling his theory a *General Theory*, Keynes meant that he treated not only the full-employment equilibrium, but also other types of equilibria.)

Keynes believed that active government fiscal and monetary policy could be effective in combating cycles of inflation and depression. *Fiscal policy* is defined as policy regarding government expenditure, while *monetary policy* means governmental policy with respect to the money supply. Keynes advocated a counter-cyclical use of these two tools, i.e. he believed that government spending and expansionist monetary policy should be used to combat recessions and depressions, while the opposite policies should be used to cool an economy whenever it became overheated.

Keynes visited Roosevelt in Washington in 1934. Roosevelt liked him, but found his theories overly mathematical. Nevertheless Keynes ideas influenced Roosevelt's policies, especially in 1937, when a new dip in the economy occurred. Over the years, Keynes' advocacy of counter-cyclical governmental intervention has become widely accepted, especially by social-democratic governments in Europe.

The New Deal measures inaugurated by Roosevelt were only partially effective in producing full employment. The reason that they were only partially successful was that although they were designed to help business get restarted, they were viewed with hostility by the business community. This hostility prevented Roosevelt from using fiscal policy on a large enough scale to produce full employment. Also, because businessmen felt uneasy with the new political climate, business investment remained sluggish.

One of the conclusions of Keynes' *General Theory* was that investment by expanding businesses is essential to keep an economy from contracting. This conclusion is worrying, because in the future, exponential expansion of business activity will gradually become less and less possible. Thus we can visualize a future need for governmental intervention to prevent a depression.

During World War II, Keynes advice on how to finance the war effort was sought by the British government. He did as much as he could, but his activity was limited by increasing

heart problems. At the end of the war, Keynes represented England at the Breton Woods Conference, which established the World Bank and the International Monetary Fund. He received many honors - for example, he became Lord Keynes. However, his health remained unstable, and in 1946 he died of a heart attack. His life and work had produced a permanent change from the *laissez faire* economics of Adam Smith to an era of recognized governmental responsibility.

6.23 The transition to a sustainable economy

The Worldwatch Institute, Washington D.C., lists the following steps as necessary for the transition to sustainability⁴:

1. Stabilizing population
2. Shifting to renewable energy
3. Increasing energy efficiency
4. Recycling resources
5. Reforestation
6. Soil Conservation

All of these steps are labor-intensive; and thus, wholehearted governmental commitment to the transition to sustainability can help to solve the problem of unemployment.

In much the same spirit that Roosevelt (with Keynes' approval) used governmental powers to end the great depression, we must now urge our governments to use their powers to promote sustainability and to reduce the trauma of the transition to a steady-state economy. For example, an increase in the taxes on fossil fuels could make a number of renewable energy technologies economically competitive; and higher taxes on motor fuels would be especially useful in promoting the necessary transition from private automobiles to bicycles and public transportation. Tax changes could also be helpful in motivating smaller families.

Governments already recognize their responsibility for education. In the future, they must also recognize their responsibility for helping young people to make a smooth transition from education to secure jobs. If jobs are scarce, work must be shared, in a spirit of solidarity, among those seeking employment; hours of work (and if necessary, living standards) must be reduced to insure a fair distribution of jobs. Market forces alone cannot achieve this. The powers of government are needed.

Economic activity is usually divided into two categories, 1) production of goods and 2) provision of services. It is the rate of production of goods that will be limited by the carrying capacity of the global environment. Services that have no environmental impact

⁴L.R. Brown and P. Shaw, 1982.



Figure 6.23: **A reforestation project in Burkina Faso. Projects such as this may help the world to achieve sustainability, while simultaneously helping to solve problems of unemployment.**

will not be constrained in this way. Thus a smooth transition to a sustainable economy will involve a shift of a large fraction the work force from the production of goods to the provision of services.

In his recent popular book *The Rise of the Creative Class*, the economist Richard Florida points out that in a number of prosperous cities - for example Stockholm - a large fraction of the population is already engaged in what might be called creative work - a type of work that uses few resources, and produces few waste products - work which develops knowledge and culture rather than producing material goods. For example, producing computer software requires few resources and results in few waste products. Thus it is an activity with a very small ecological footprint. Similarly, education, research, music, literature and art are all activities that do not weigh heavily on the carrying capacity of the global environment. Florida sees this as a pattern for the future, and maintains that everyone is capable of creativity. He visualizes the transition to a sustainable future economy as one in which a large fraction of the work force moves from industrial jobs to information-related work. Meanwhile, as Florida acknowledges, industrial workers feel uneasy and threatened by such trends.

6.24 Population and goods per capita

In the distant future, the finite carrying capacity of the global environment will impose limits on the amount of resource-using and waste-generating economic activity that it will be possible for the world to sustain. The consumption of goods per capita will be equal to this limited total economic activity divided by the number of people alive at that time. Thus, our descendants will have to choose whether they want to be very numerous and very poor, or less numerous and more comfortable, or very few and very rich. Perhaps the middle way will prove to be the best.

Given the fact that environmental carrying capacity will limit the sustainable level of resource-using economic activity to a fixed amount, average wealth in the distant future will be approximately inversely proportional to population over a certain range of population values.⁵

Suggestions for further reading

1. W. Bowden, *Industrial Society in England Towards the End of the Eighteenth Century*, MacMillan, New York, (1925).
2. G.D. Cole, *A Short History of the British Working Class Movement*, MacMillan, New York, (1927).
3. P. Deane, *The First Industrial Revolution*, Cambridge University Press, (1969).
4. Marie Boaz, *Robert Boyle and Seventeenth Century Chemistry*, Cambridge University Press (1958).
5. J.G. Crowther, *Scientists of the Industrial Revolution*, The Cresset Press, London (1962).
6. R.E. Schofield, *The Lunar Society of Birmingham*, Oxford University Press (1963).
7. L.T.C. Rolt, *Isambard Kingdom Brunel*, Arrow Books, London (1961).
8. J.D. Bernal, *Science in History*, Penguin Books Ltd. (1969).
9. Bertrand Russell, *The Impact of Science on Society*, Unwin Books, London (1952).
10. Wilbert E. Moore, *The Impact of Industry*, Prentice Hall (1965).
11. Charles Morazé, *The Nineteenth Century*, George Allen and Unwin Ltd., London (1976).
12. Carlo M. Cipolla (editor), *The Fontana Economic History of Europe*, Fontana/Collins, Glasgow (1977).
13. Martin Gerhard Geisbrecht, *The Evolution of Economic Society*, W.H. Freeman and Co. (1972).
14. P.N. Stearns, *The Industrial Revolution in World History*, Westview Press, (1998).
15. E.P. Thompson, *The Making of the English Working Class*, Pennguin Books, London, (1980).

⁵Obviously, if the number of people is reduced to such an extent that it approaches zero, the average wealth will not approach infinity, since a certain level of population is needed to maintain a modern economy. However, if the global population becomes extremely large, the average wealth will indeed approach zero.

16. N.J. Smelser, *Social Change and the Industrial Revolution: An Application of Theory to the British Cotton Industry*, University of Chicago Press, (1959).
17. D.S. Landes, *The Unbound Prometheus: Technical Change and Industrial Development in Western Europe from 1750 to the Present, 2nd ed.*, Cambridge University Press, (2003).
18. S. Pollard, *Peaceful Conquest: The Industrialization of Europe, 1760-1970*, Oxford University Press, (1981).
19. M. Kranzberg and C.W. Pursell, Jr., eds., *Technology in Western Civilization*, Oxford University Press, (1981).
20. M.J. Daunton, *Progress and Poverty: An Economic and Social History of Britain, 1700-1850*, Oxford University Press, (1990).
21. L.R. Berlanstein, *The Industrial Revolution and Work in 19th Century Europe*, Routledge, (1992).
22. J.D. Bernal, *Science and Industry in the 19th Century*, Indiana University Press, Bloomington, (1970).
23. Marie Boaz, *Robert Boyle and Seventeenth Century Chemistry*, Cambridge University Press (1958).
24. J.G. Crowther, *Scientists of the Industrial Revolution*, The Cresset Press, London (1962).
25. R.E. Schofield, *The Lunar Society of Birmingham*, Oxford University Press (1963).
26. L.T.C. Rolt, *Isambard Kingdom Brunel*, Arrow Books, London (1961).
27. J.D. Bernal, *Science in History*, Penguin Books Ltd. (1969).
28. Bertrand Russell, *The Impact of Science on Society*, Unwin Books, London (1952).
29. Wilbert E. Moore, *The Impact of Industry*, Prentice Hall (1965).
30. Charles Morazé, *The Nineteenth Century*, George Allen and Unwin Ltd., London (1976).
31. Carlo M. Cipolla (editor), *The Fontana Economic History of Europe*, Fontana/Collins, Glasgow (1977).
32. Richard Storry, *A History of Modern Japan*, Penguin Books Ltd. (1960).
33. Martin Gerhard Geisbrecht, *The Evolution of Economic Society*, W.H. Freeman and Co. (1972).
34. R. Owen, *A New View of Society, or, Essays on the Formation of the Human Character Preparatory for the Development of a Plan for Gradually Ameliorating the Condition of Mankind*, Longman, London, (1916).
35. R. Owen, *The Life of Robert Owen, by Himself*, ed. M. Beer, Knopf, New York, (1920).
36. R. Podmore, *Robert Owen, A Biography*, Allan and Unwin, (1906).
37. G.D.H. Cole, *Life of Robert Owen*, Macmillan, (1930).
38. J. Butt, ed., *Robert Owen: Prince of Cotton Spinners*, David and Charles, (1971).
39. G. Claeys, ed., *A New View of Society and other writings by Robert Owen*, Penguin Classics, (1991).
40. G. Claeys, ed., *Selected Works of Robert Owen in 4 volumes*, Pickering, (1993).

41. R. Sobel, *The Big Board: A History of the New York Stock Market*, Beard Books, (2000).
42. A. Kohn, *No Contest - The Case Against Competition*, Houghton Mifflin Co., (1986).
43. A.T. Vanderbilt, *Fortune's Children: The Fall of the House of Vanderbilt*, William Morrow, New York, (1989).
44. D. Nasaw, *Andrew Carnegie*, Penguin Press, New York, (2006).
45. J.R.T. Hughes, *The Vital Few: American Economic Progress and its Protagonists*, Houghton and Mifflin, Boston, (1965).
46. H. Livesay, *Andrew Carnegie and the Rise of Big Business*, Houghton Mifflin, Boston, (1975).
47. G. Wright, *The Origins of American Industrial Success, 1879-1940*, American Economic Review, **80**, 651-668, (1990).
48. A. Carnegie, *Autobiography of Andrew Carnegie*, Houghton Mifflin, Boston, (1920).
49. A. Carnegie, *Triumphant Democracy, or, Fifty Year's March of the Republic*, Scribners, New York, (1886).
50. A. Maddison, *The World Economy: A Millennial Perspective*, Overseas Press, New Delhi, (2003).
51. M. Steinberg, *Voices of Revolution, 1917*, Yale University Press, (2001).
52. R. Malone, *Analysing the Russian Revolution*, Cambridge University Press, Melbourne, (2004).
53. O. Figes, *A People's Tragedy: The Russian Revolution, 1891-1924*, ISBN 0-14-024364-X.
54. M.B. Levin, *Political Hysteria in America: The Democratic Capacity for Repression*, Basic Books, (1971).
55. J.E. Haynes, *Red Scare of Red Menace? American Communism and Anti Communism in the Cold War Era*, Ivan R. Dee, (2000).
56. A. Fried, *McCarthyism, The Great American Red Scare: A Documentary History*, Oxford University Press, (1997).
57. T. Morgan, *Reds: McCarthyism in Twentieth-Century America*, Random House, (2004).
58. E. Schrecker, *Many Are the Crimes: McCarthyism in America*, Little, Brown, (1998).
59. R. Fishman, *Bourgeois Utopias: The Rise and Fall of Suburbia*, Basic Books, (1987).
60. R. Fishman, *America's New City: Megalopolis Unbounded*, Wilson Quarterly, **14**, 24-45, (1990).
61. J. Borchert, *Residential City Suburbs: The Emergence of a New Suburban Type, 1880-1930*, Journal of Urban History, **22**, 283-307, (1996).
62. K.A. Danielsen et al., *Retracting Suburbia: Smart Growth and the Future of Housing*, Housing Policy Debate, **10**, 513-540, (1999).
63. J. Garreau, *Edge City: Life on the New Frontier*, Doubleday, New York, (1991).
64. R.E. Lang, *Edgeless Cities: Exploring the Elusive Metropolis*, Brookings Institution Press, Washington D.C., (2002).
65. S.B. Warner, *Streetcar Suburbs: The Process of Growth in Boston 1870-1890*, Cambridge Mass., (1962).

66. K.M. Kruse and T.J. Sugrue, eds., *The New Suburban History*, University of Chicago Press, (2006).
67. B. Kelly, *Expanding the American Dream: Building and Rebuilding Levittown*, State University of Albany Press, Albany NY, (1993).
68. J.E. Stiglitz, *Globalization and its Discontents*, W.W. Norton, New York, (2002).
69. J.E. Stiglitz, *Making Globalization Work*, W.W. Norton, New York, (2006).
70. M. Steger, *Globalization: A Very Short Introduction*, Oxford University Press, (2003).
71. A. MacGillivray, *A Brief History of Globalization: The Untold Story of our Incredibly Shrinking Planet*, Carroll and Graf, (2006).
72. T.L. Friedman, *The World is Flat*, Farrar, Straus and Giroux, (2006).
73. J. Pilger, *The New Rulers of the World*, Verso Books, (2003).
74. R.J. Barrow, *Determinants of Economic Growth: A Cross-Country Empirical Study*, MIT Press, Cambridge MA, (1997).
75. D.K. Foley, *Growth and Distribution*, Harvard University Press, (1999).
76. C.I. Jones, *Introduction to Economic Growth, 2nd ed.*, W.W. Norton, (2002).
77. S. Vaclav, *China's Environmental Crisis: An Inquiry into the Limits of National Development*, M.E. Sharpe, Armonk, (1992).
78. J.D. Hammond and C.H. Claire, eds., *Making Chicago Price Theory: Friedman-Stigler Correspondence 1945-1957*, , Routledge, (2006).
79. R. Tilman, *The Intellectual Legacy of Thorstein Veblen: Unresolved Issues*, Greenwood Press, (1996).
80. R. Tilman, *Thorstein Veblen and His Critics, 1891-1963*, Princeton University Press, (1992).
81. K. McCormick, *Veblen in Plain English*, Cambria Press, (2006).
82. J. Dorfman, *Thorstein Veblen and His America*, Harvard University Press, (1934).
83. J. Homer, ed., *The Gandhi Reader: A Sourcebook of his Life and Writings*, Grove Press, New York, (1956).
84. G. Sharp, *Gandhi as a Political Strategist, with Essays on Ethics and Politics*, Extending Horizon Books, Boston, (1979).
85. J.V. Bondurant, *Conquest of Violence: The Gandhian Philosophy of Conflict*, Princeton University Press, (1988).
86. L. Fischer, *The Essential Gandhi: An Anthology of his Writings on His Life, Work and Ideas*, Vintage, New York, (2002).
87. M.K. Gandhi, *Hind Swaraj and Other Writings*, edited by A.J. Parel, Cambridge Texts in Modern Politics, (2006).
88. C. Bode, *Best of Thoreau's Journals*, Southern Illinois University Press, (1967).
89. J. Meyerson et al., *The Cambridge Companion to Henry David Thoreau*, Cambridge University Press, (1995).
90. W. Howarth, *The Book of Concord: Thoreau's Life as a Writer*, Viking Press, (1982).
91. W. Harding, *Days of Henry Thoreau*, Princeton University Press, (1982).
92. T. Roszak, *The Making of a Counter Culture*, (1970).
93. E. Nelson, *The British Counterculture 1966-1973*, Macmillan, London, (1989).

94. G. McKay, *Senseless Acts of Beauty: Cultures of Resistance since the Sixties*, Verso, London, (1996).
95. K. Goffman, *Counterculture Through the Ages*, Villard Books, (2004).
96. Brundtland Commission, *Our Common Future*, Oxford University Press, (1987).
97. G.O. Barney, , *The Unfinished Agenda: The Citizen's Policy Guide to Environmental Issues*, Thomas Y. Crowell, New York, (1977).
98. R.E. Benedick, *Ozone Diplomacy: New Directions in Safeguarding the Planet*, Harvard University Press, Cambridge, (1991).
99. T. Berry, *The Dream of the Earth*, Sierra Club Books, San Francisco, (1988).
100. L.R. Brown, *The Twenty-Ninth Day*, W.W. Norton, New York, (1978).
101. M.E. Clark, *Ariadne's Thread: The Search for New Modes of Thinking*, St. Martin's Press, New York, (1989).
102. W.C. Clark and others, *Managing Planet Earth*, Special Issue, *Scientific American*, September, (1989).
103. B. Commoner, *The Closing Circle: Nature, Man and Technology*, Bantam Books, New York, (1972).
104. Council on Environmental Quality and U.S. Department of State, *Global 2000 Report to the President: Entering the Twenty-First Century*, Technical Report, Volume 2, U.S. Government Printing Office, Washington D.C., (1980).
105. J.C.I. Dooge et al. (editors), *Agenda of Science for Environment and Development into the 21st Century*, Cambridge University Press, (1993).
106. E. Eckholm, *The Picture of Health: Environmental Sources of Disease*, New York, (1976).
107. Economic Commission for Europe, *Air Pollution Across Boundaries*, United Nations, New York, (1985).
108. P.R. Ehrlich, A.H. Ehrlich and J. Holdren, *Ecoscience: Population, Resources, Environment*, W.H. Freeman, San Francisco, (1977)
109. P.R. Ehrlich and A.H. Ehrlich, *Extinction*, Victor Gollancz, London, (1982).
110. P.R. Ehrlich and A.H. Ehrlich, *Healing the Planet*, Addison Wesley, Reading MA, (1991).
111. C. Flavin, *Slowing Global Warming: A Worldwide Strategy*, Worldwatch Paper 91, Worldwatch Institute, Washington D.C., (1989).
112. H.F. French, *Clearing the Air: A Global Agenda* , Worldwatch Paper 94, Worldwatch Institute, Washington D.C., (1990).
113. H.F. French, *After the Earth Summit: The Future of Environmental Governance*, Worldwatch Paper 107, Worldwatch Institute, Washington D.C., (1992).
114. G. Hagman and others, *Prevention is Better Than Cure*, Report on Human Environmental Disasters in the Third World, Swedish Red Cross, Stockholm, Stockholm, (1986).
115. G. Hardin, "The Tragedy of the Commons", *Science*, December 13, (1968).
116. P.W. Hemily and M.N. Ozdas (eds.) *Science and Future Choice*, Clarendon, Oxford, (1979).
117. IUCN, UNEP, WWF, *Caring for the Earth*, Earthscan Publications, London, (1991).

118. L. Rosen and R. Glasser (eds.), *Climate Change and Energy Policy*, Los Alamos National Laboratory, AIP, New York, (1992).
119. J.J. MacKenzie and M.T. El-Ashry, *Ill Winds: Airborne Pollution's Toll on Trees and Crops*, World Resources Institute, Washington D.C., (1988).
120. J.T. Mathews (editor), *Preserving the Global Environment: The Challenge of Shared Leadership*, W.W. Norton, New York, (1991).
121. J. McCormick, *Acid Earth*, International Institute for Environment and Development, London, (1985).
122. N. Myers, *The Sinking Ark*, Pergamon, New York, (1972).
123. N. Myers, *Conservation of Tropical Moist Forests*, National Academy of Sciences, Washington D.C., (1980).
124. D.W. Orr, *Ecological Literacy*, State University of New York Press, Albany, (1992).
125. D.C. Pirages and P.R. Ehrlich, *Ark II: Social Responses to Environmental Imperatives*, W.H. Freeman, San Francisco, (1974).
126. J. Rotblat (ed.), *Shaping Our Common Future: Dangers and Opportunities (Proceedings of the Forty-Second Pugwash Conference on Science and World Affairs)*, World Scientific, London, (1994).
127. J.C. Ryan, *Life Support: Conserving Biological Diversity*, Worldwatch Paper 108, Worldwatch Institute, Washington D.C., (1992).
128. S.F. Singer, *Global Effects of Environmental Pollution*, Springer Verlag, New York, (1971).
129. B. Stokes, *Local Responses to Global Problems: A Key to Meeting Basic Human Needs*, Worldwatch Paper 17, Worldwatch Institute, Washington D.C., (1978).
130. L. Timberlake, *Only One Earth: Living for the Future*, BBC/ Earthscan, London, (1987).
131. UNEP, *Environmental Data Report*, Blackwell, Oxford, (published annually).
132. UNESCO, *International Coordinating Council of Man and the Biosphere*, MAB Report Series No. 58, Paris, (1985).
133. P.M. Vitousek, P.R. Ehrlich, A.H. Ehrlich and P.A. Matson, *Human Appropriation of the Products of Photosynthesis*, *Bioscience*, 34, 368-373, (1986).
134. B. Ward and R. Dubos, *Only One Earth*, Penguin Books Ltd., (1973).
135. P. Weber, *Abandoned Seas: Reversing the Decline of the Oceans*, Worldwatch Paper 116, Worldwatch Institute, Washington D.C., (1993).
136. E.O. Wilson (ed.), *Biodiversity*, National Academy Press, Washington D.C., (1988).
137. E.O. Wilson, *The Diversity of Life*, Allen Lane, The Penguin Press, London, (1992).
138. G. Woodwell (ed.), *The Earth in Transition: Patterns and Processes of Biotic Impoverishment*, Cambridge University Press, (1990).
139. World Commission on Environment and Development, *Our Common Future*, Oxford University Press, (1987).
140. World Resources Institute (WRI), *Global Biodiversity Strategy*, The World Conservation Union (IUCN), United Nations Environment Programme (UNEP), (1992).
141. R.L. Heilbroner, *The Worldly Philosophers, 5th edition*, Simon and Schuster, (1980).
142. R. Harrod, *Life of John Maynard Keynes*, Harcourt, Brace, New York, (1951).

143. J.M. Keynes, *Economic Consequences of the Peace*, Harcourt, Brace, New York, (1920).
144. J.M. Keynes, *Essays in Persuasion*, Harcourt, Brace, New York, (1951).
145. J.M. Keynes, *The General Theory of Employment, Interest and Money*, Harcourt, Brace, New York, (1964).
146. R. Lekachman, *The Age of Keynes*, Random House, New York, (1966).
147. R. Florida, *The Rise of the Creative Class*, Basic Books, (2002).
148. H.E. Daly, *Steady-State Economics: The Economics of Biophysical Equilibrium and Moral Growth*, W.H. Freeman, San Francisco, (1977).
149. H.E. Daly, *Steady-State Economics*, Island Press, Washington D.C., (1991).
150. H.E. Daly, *Economics, Ecology and Ethics: Essays Towards a Steady-State Economy*, W.H. Freeman, San Francisco, (1980).
151. H.E. Daly, *For the Common Good*, Beacon Press, Boston, (1989).
152. Aspen Institute for Humanistic Studies, Program in International Affairs, *The Planetary Bargain*, Aspen, Colorado, (1975).
153. W. Berry, *Home Economics*, North Point Press, San Francisco, (1987).
154. L.R. Brown, *Building a Sustainable Society*, W.W. Norton, (1981).
155. L.R. Brown, and P. Shaw, *Six Steps to a Sustainable Society*, Worldwatch Paper 48, Worldwatch Institute, Washington D.C., (1982).
156. E. Eckholm, *Planting for the Future: Forestry for Human Needs*, Worldwatch Paper 26, Worldwatch Institute, Washington D.C., (1979).
157. R. Goodland, H. Daly, S. El Serafy and B. von Droste (editors), *Environmentally Sustainable Economic Development: Building on Brundtland*, UNESCO, Paris, (1991).
158. F. Hirsch, *Social Limits to Growth*, Harvard University Press, Cambridge, (1976).
159. W. Leontief, et al., *The Future of the World Economy*, Oxford University Press, (1977).
160. M. Lipton, *Why Poor People Stay Poor*, Harvard University Press, (1977).
161. J. McHale, and M.C. McHale, *Basic Human Needs: A Framework for Action*, Center for Integrative Studies, Huston, (1977).
162. D.L. Meadows, *Alternatives to Growth*, Ballinger, Cambridge, (1977).
163. D.H. Meadows, *The Global Citizen*, Island Press, Washington D.C., (1991).
164. D.L. Meadows, and D.H. Meadows (editors), *Toward Global Equilibrium*, Wright-Allen Press, Cambridge, Mass., (1973).
165. L.W. Milbrath, *Envisioning a Sustainable Society*, State University of New York Press, Albany, (1989).
166. R.E. Miles, *Awakening from the American Dream: The Social and Political Limits to Growth*, Universe Books, New York, (1976).
167. S. Postel, and L. Heise, *Reforesting the Earth*, Worldwatch Paper 83, Worldwatch Institute, Washington D.C., (1988).
168. M. Sagoff, *The Economy of the Earth*, Cambridge University Press, (1988).
169. E.F. Schumacher, *Small is Beautiful: Economics As If People Mattered*, Harper and Row, New York, (1973).

170. World Bank, *World Development Report*, Oxford University Press, New York, (published annually).
171. G.P. Zachary, *A 'Green Economist' Warns Growth May Be Overrated*, The Wall Street Journal, June 25, (1996).
172. H.E. Daly, *Sustainable Growth - An Impossibility Theorem*, *Development*, **3**, 45-47, (1990).
173. H.E. Daly and K.N. Townsend, (editors), *Valuing the Earth. Economics, Ecology, Ethics*, MIT Press, Cambridge, Massachusetts, (1993)

Chapter 7

THE HISTORY OF COMPUTERS

7.1 Pascal and Leibniz

If civilization survives, historians in the distant future will undoubtedly regard the invention of computers as one of the most important steps in human cultural evolution - as important as the invention of writing or the invention of printing. The possibilities of artificial intelligence have barely begun to be explored, but already the impact of computers on society is enormous.

The first programmable universal computers were completed in the mid-1940's; but they had their roots in the much earlier ideas of Blaise Pascal (1623-1662), Gottfried Wilhelm Leibniz (1646-1716), Joseph Marie Jacquard (1752-1834) and Charles Babbage (1791-1871).

In 1642, the distinguished French mathematician and philosopher Blaise Pascal completed a working model of a machine for adding and subtracting. According to tradition, the idea for his "calculating box" came to Pascal when, as a young man of 17, he sat thinking of ways to help his father (who was a tax collector). In describing his machine, Pascal wrote: "I submit to the public a small machine of my own invention, by means of which you alone may, without any effort, perform all the operations of arithmetic, and may be relieved of the work which has often times fatigued your spirit when you have worked with the counters or with the pen."

Pascal's machine worked by means of toothed wheels. It was much improved by Leibniz, who constructed a mechanical calculator which, besides adding and subtracting, could also multiply and divide. His first machine was completed in 1671; and Leibniz' description of it, written in Latin, is preserved in the Royal Library at Hanover: "There are two parts of the machine, one designed for addition (and subtraction), and the other designed for multiplication (and division); and they should fit together. The adding (and subtracting) machine coincides completely with the calculating box of Pascal. Something, however, must be added for the sake of multiplication..."

"The wheels which represent the multiplicand are all of the same size, equal to that of the wheels of addition, and are also provided with ten teeth which, however, are movable



Figure 7.1: Blaise Pascal (1623-1662) was a French mathematician, physicist, writer, inventor and theologian. Pascal, a child prodigy, was educated by his father, who was a tax-collector. He invented his calculating box to make his father's work less tedious.



Figure 7.2: The German mathematician, philosopher and universal genius Gottfried Wilhelm von Leibniz (1646-1716) was a contemporary of Isaac Newton. He invented differential and integral calculus independently, just as Newton had done many years earlier. However, Newton had not published his work on calculus, and thus a bitter controversy over priority was precipitated. When his patron, the Elector of Hanover moved to England to become George I, Leibniz was left behind because the Elector feared that the controversy would alienate the English. Leibniz extended Pascal's calculating box so that it could perform multiplication and division. Calculators of his design were still being used in the 1960's.

so that at one time there should protrude 5, at another 6 teeth, etc., according to whether the multiplicand is to be represented five times or six times, etc.”

“For example, the multiplicand 365 consists of three digits, 3, 6, and 5. Hence the same number of wheels is to be used. On these wheels, the multiplicand will be set if from the right wheel there protrude 5 teeth, from the middle wheel 6, and from the left wheel 3.”

7.2 Jacquard and Babbage

By 1810, calculating machines based on Leibniz' design were being manufactured commercially; and mechanical calculators of a similar (if much improved) design could be found in laboratories and offices until the 1960's. The idea of a programmable universal computer is due to the English mathematician, Charles Babbage, who was the Lucasian Professor of Mathematics at Cambridge University. (In the 17th century, Isaac Newton held this post, and in the 20th century, P.A.M. Dirac and Stephen Hawking also held it.)

In 1812, Babbage conceived the idea of constructing a machine which could automat-

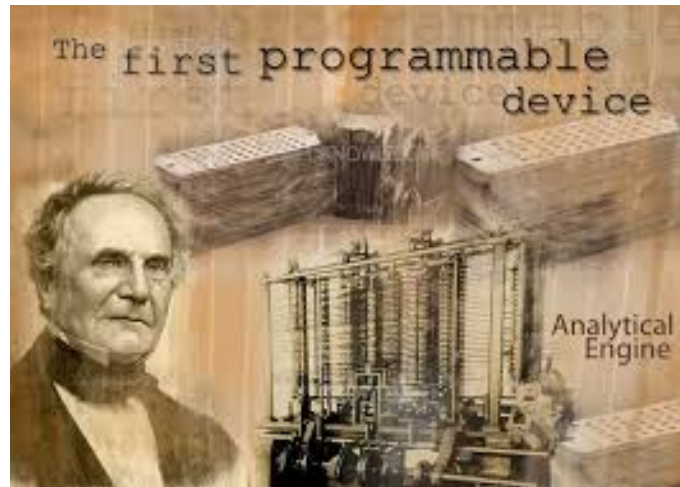

Figure 7.3: Charles Babbage (1791-1871) and his analytical engine.

ically produce tables of functions, provided that the functions could be approximated by polynomials. He constructed a small machine, which was able to calculate tables of quadratic functions to eight decimal places, and in 1832 he demonstrated this machine to the Royal Society and to representatives of the British government.

The demonstration was so successful that Babbage secured financial support for the construction of a large machine which would tabulate sixth-order polynomials to twenty decimal places. The large machine was never completed, and twenty years later, after having spent seventeen thousand pounds on the project, the British government withdrew its support. The reason why Babbage's large machine was never finished can be understood from the following account by Lord Moulton of a visit to the mathematician's laboratory:

"One of the sad memories of my life is a visit to the celebrated mathematician and inventor, Mr. Babbage. He was far advanced in age, but his mind was still as vigorous as ever. He took me through his workrooms."

"In the first room I saw the parts of the original Calculating Machine, which had been shown in an incomplete state many years before, and had even been put to some use. I asked him about its present form. 'I have not finished it, because in working at it, I came on the idea of my Analytical Machine, which would do all that it was capable of doing, and much more. Indeed, the idea was so much simpler that it would have taken more work to complete the Calculating Machine than to design and construct the other in its entirety; so I turned my attention to the Analytical Machine.'"

"After a few minutes talk, we went into the next workroom, where he showed me the working of the elements of the Analytical Machine. I asked if I could see it. 'I have never completed it,' he said, 'because I hit upon the idea of doing the same thing by a different and far more effective method, and this rendered it useless to proceed on the old lines.'"

"Then we went into a third room. There lay scattered bits of mechanism, but I saw no trace of any working machine. Very cautiously I approached the subject, and received the dreaded answer: 'It is not constructed yet, but I am working at it, and will take less time



Figure 7.4: **Joseph Marie Jacquard (1752-1834) invented a loom which could be programed to produce any design by means of punched cards. News of his invention inspired Babbage to invent a universal programmable computing machine.**

to construct it altogether than it would have taken to complete the Analytical Machine from the stage in which I left it.’ I took leave of the old man with a heavy heart.”

Babbage’s first calculating machine was a special-purpose mechanical computer, designed to tabulate polynomial functions; and he abandoned this design because he had hit on the idea of a universal programmable computer. Several years earlier, the French inventor Joseph Marie Jacquard had constructed an automatic loom in which large wooden “punched cards” were used to control the warp threads. Inspired by Jacquard’s invention, Babbage planned to use punched cards to program his universal computer. (Jacquard’s looms could be programmed to weave extremely complex patterns: A portrait of the inventor, woven on one of his looms in Lyon, hung in Babbage’s drawing room.)

One of Babbage’s frequent visitors was Augusta Ada¹, Countess of Lovelace (1815-1852), the daughter of Lord and Lady Byron. She was a mathematician of considerable ability, and it is through her lucid descriptions that we know how Babbage’s never-completed Analytical Machine was to have worked.

¹ The programming language ADA is named after her.



Figure 7.5: **Jacquard's loom.**



Figure 7.6: Lord Byron's daughter, Augusta Ada, Countess of Lovelace (1815-1852) was an accomplished mathematician and a frequent visitor to Babbage's workshop. It is through her lucid description of his ideas that we know how Babbage's universal calculating machine was to have worked. The programming language ADA is named after her.

7.3 Harvard's sequence-controlled calculator

The next step towards modern computers was taken by Herman Hollerith, a statistician working for the United States Bureau of the Census. He invented electromechanical machines for reading and sorting data punched onto cards. Hollerith's machines were used to analyze the data from the 1890 United States Census. Because the Census Bureau was a very limited market, Hollerith branched out and began to manufacture similar machines for use in business and administration. His company was later bought out by Thomas J. Watson, who changed its name to International Business Machines.

In 1937, Howard Aiken, of Harvard University, became interested in combining Babbage's ideas with some of the techniques which had developed from Hollerith's punched card machines. He approached the International Business Machine Corporation, the largest manufacturer of punched card equipment, with a proposal for the construction of a large, automatic, programmable calculating machine.

Aiken's machine, the Automatic Sequence Controlled Calculator (ASCC), was completed in 1944 and presented to Harvard University. Based on geared wheels, in the Pascal-Leibniz-Babbage tradition, ASCC had more than three quarters of a million parts and used 500 miles of wire. ASCC was unbelievably slow by modern standards - it took three-tenths of a second to perform an addition - but it was one of the first programmable general-purpose digital computers ever completed. It remained in continuous use, day and night, for fifteen years.



Figure 7.7: The Automatic Sequence-Controlled Calculator ASCC can still be seen by visitors at Harvard's science building and cafeteria.

7.4 The first electronic computers

In the ASCC, binary numbers were represented by relays, which could be either on or off. The on position represented 1, while the off position represented 0, these being the only two digits required to represent numbers in the binary (base 2) system. Electromechanical calculators similar to ASCC were developed independently by Konrad Zuse in Germany and by George R. Stibitz at the Bell Telephone Laboratory.

Electronic digital computers

In 1937, the English mathematician A.M. Turing published an important article in the Proceedings of the London Mathematical Society in which envisioned a type of calculating machine consisting of a long row of cells (the “tape”), a reading and writing head, and a set of instructions specifying the way in which the head should move the tape and modify the state and “color” of the cells on the tape. According to a hypothesis which came to be known as the “Church-Turing hypothesis”, the type of computer proposed by Turing was capable of performing every possible type of calculation. In other words, the Turing machine could function as a universal computer.

In 1943, a group of English engineers, inspired by the ideas of Alan Turing and those of the mathematician M.H.A. Newman, completed the electronic digital computer Colossus. Colossus was the first large-scale electronic computer. It was used to break the German Enigma code; and it thus affected the course of World War II.

In 1946, ENIAC (Electronic Numerical Integrator and Calculator) became operational. This general-purpose computer, designed by J.P. Eckert and J.W. Mauchley of the University of Pennsylvania, contained 18,000 vacuum tubes, one or another of which was often out of order. However, during the periods when all its vacuum tubes were working, an electronic computer like Colossus or ENIAC could shoot ahead of an electromechanical machine (such as ASCC) like a hare outdistancing a tortoise.

During the summer of 1946, a course on “The Theory and Techniques of Electronic Digital Computers” was given at the University of Pennsylvania. The ideas put forward in this course had been worked out by a group of mathematicians and engineers headed by J.P. Eckert, J.W. Mauchley and John von Neumann, and these ideas very much influenced all subsequent computer design.

Cybernetics

The word “Cybernetics”, was coined by the American mathematician Norbert Wiener (1894-1964) and his colleagues, who defined it as “the entire field of control and communication theory, whether in the machine or in the animal”. Wiener derived the word from the Greek term for “steersman”.

Norbert Wiener began life as a child prodigy: He entered Tufts University at the age of 11 and received his Ph.D. from Harvard at 19. He later became a professor of mathematics at the Massachusetts Institute of Technology. In 1940, with war on the horizon,



Figure 7.8: Alan Turing (1912-1954). He is considered to be the father of theoretical computer science. During World War II, Turing's work allowed the allies to crack the German's code. This appreciably shortened the length of the war in Europe, and saved many lives.



Figure 7.9: John von Neumann (1903-1957, right) with J. Robert Oppenheimer. In the background is an electronic digital computer.

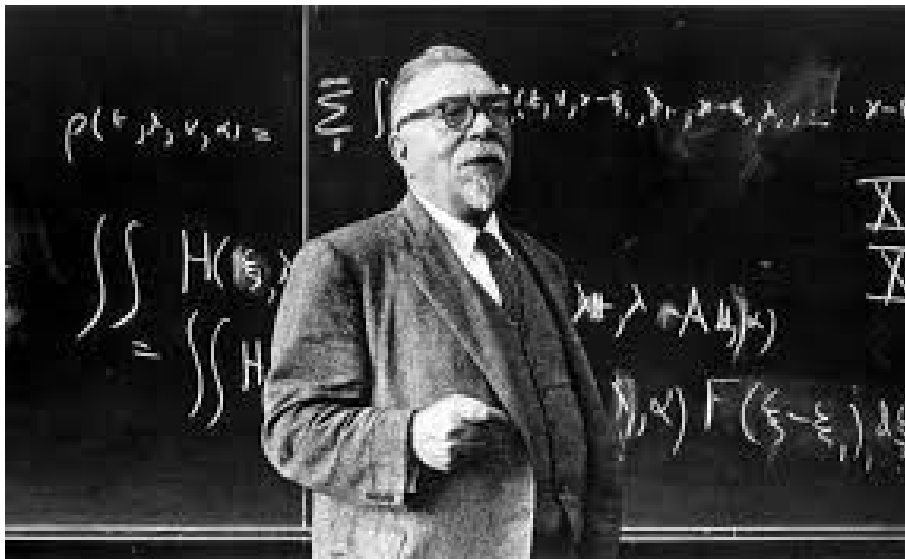

Figure 7.10: MIT's Norbert Wiener (1894-1964) coined the word “Cybernetics”, derived from a Greek word meaning “steersman”. Wiener was one of the principle organizers of the Macy Conferences.

Wiener sent a memorandum to Vannevar Bush, another MIT professor who had done pioneering work with analogue computers, and had afterwards become the chairman of the U.S. National Defense Research Committee. Wiener's memorandum urged the American government to support the design and construction of electronic digital computers, which would make use of binary numbers, vacuum tubes, and rapid memories. In such machines, the memorandum emphasized, no human intervention should be required except when data was to be read into or out of the machine.

Like Leo Szilard, John von Neumann, Claude Shannon and Erwin Schrödinger, Norbert Wiener was aware of the relation between information and entropy. In his 1948 book *Cybernetics* he wrote: “...we had to develop a statistical theory of the amount of information, in which the unit amount of information was that transmitted by a single decision between equally probable alternatives. This idea occurred at about the same time to several writers, among them the statistician R.A. Fisher, Dr. Shannon of Bell Telephone Laboratories, and the author. Fisher's motive in studying this subject is to be found in classical statistical theory; that of Shannon in the problem of coding information; and that of the author in the problem of noise and message in electrical filters... The notion of the amount of information attaches itself very naturally to a classical notion in statistical mechanics: that of entropy. Just as the amount of information in a system is a measure of its degree of organization, so the entropy of a system is a measure of its degree of disorganization; and the one is simply the negative of the other.”

During World War II, Norbert Wiener developed automatic systems for control of anti-aircraft guns. His systems made use of feedback loops closely analogous to those with which animals coordinate their movements. In the early 1940's, he was invited to attend a



Figure 7.11: Margaret Mead (1901-1978) and Gregory Bateson (1904-1980). They used the feedback loops studied by Wiener to explain many aspects of human behavior. Bateson is considered to be one of the main founders of the discipline Biosemiotics, which considers information to be the central feature of living organisms.

series of monthly dinner parties organized by Arturo Rosenbluth, a professor of physiology at Harvard University. The purpose of these dinners was to promote discussions and collaborations between scientists belonging to different disciplines. The discussions which took place at these dinners made both Wiener and Rosenbluth aware of the relatedness of a set of problems that included homeostasis and feedback in biology, communication and control mechanisms in neurophysiology, social communication among animals (or humans), and control and communication involving machines.

Wiener and Rosenbluth therefore tried to bring together workers in the relevant fields to try to develop common terminology and methods. Among the many people whom they contacted were the anthropologists Gregory Bateson and Margaret Mead, Howard Aiken (the designer of the Automatic Sequence Controlled Calculator), and the mathematician John von Neumann. The Josiah Macy Jr. Foundation sponsored a series of ten yearly

meetings, which continued until 1949 and which established cybernetics as a new research discipline. It united areas of mathematics, engineering, biology, and sociology which had previously been considered unrelated. Among the most important participants (in addition to Wiener, Rosenbluth, Bateson, Mead, and von Neumann) were Heinz von Foerster, Kurt Lewin, Warren McCulloch and Walter Pitts. The Macy conferences were small and informal, with an emphasis on discussion as opposed to the presentation of formal papers. A stenographic record of the last five conferences has been published, edited by von Foerster. Transcripts of the discussions give a vivid picture of the enthusiastic and creative atmosphere of the meetings. The participants at the Macy Conferences perceived Cybernetics as a much-needed bridge between the natural sciences and the humanities. Hence their enthusiasm. Wiener's feedback loops and von Neumann's theory of games were used by anthropologists Mead and Bateson to explain many aspects of human behavior.

7.5 Biosemiotics

The Oxford Dictionary of Biochemistry and Molecular Biology (Oxford University Press, 1997) defines Biosemiotics as "the study of signs, of communication, and of information in living organisms". The biologists Claus Emmeche and K. Kull offer another definition of Biosemiotics: "biology that interprets living systems as sign systems".

The American philosopher Charles Sanders Peirce (1839-1914) is considered to be one of the founders of Semiotics (and hence also of Biosemiotics). Peirce studied philosophy and chemistry at Harvard, where his father was a professor of mathematics and astronomy. He wrote extensively on philosophical subjects, and developed a theory of signs and meaning which anticipated many of the principles of modern Semiotics. Peirce built his theory on a triad: (1) the sign, which represents (2) something to (3) somebody. For example, the sign might be a broken stick, which represents a trail to a hunter, it might be the arched back of a cat, which represents an aggressive attitude to another cat, it might be the waggle-dance of a honey bee, which represents the coordinates of a source of food to her hive-mates, or it might be a molecule of trans-10-cis-hexadecadienol, which represents irresistible sexual temptation to a male moth of the species *Bombyx mori*. The sign might be a sequence of nucleotide bases which represents an amino acid to the ribosome-transfer-RNA system, or it might be a cell-surface antigen which represents self or non-self to the immune system. In information technology, the sign might be the presence or absence of a pulse of voltage, which represents a binary digit to a computer. Semiotics draws our attention to the sign and to its function, and places much less emphasis on the physical object which forms the sign. This characteristic of the semiotic viewpoint has been expressed by the Danish biologist Jesper Hoffmeyer in the following words: "The sign, rather than the molecule, is the basic unit for studying life."

A second important founder of Biosemiotics was Jakob von Uexküll (1864-1944). He was born in Estonia, and studied zoology at the University of Tartu. After graduation, he worked at the Institute of Physiology at the University of Heidelberg, and later at the Zoological Station in Naples. In 1907, he was given an honorary doctorate by Heidelberg



Figure 7.12: Charles Sanders Pearce (1839-1914).



Figure 7.13: Jakob Johann Baron von Uexküll (1864-1944). Together with Pearce and Bateson, he is one of the principle founders of Biosemiotics.

for his studies of the physiology of muscles. Among his discoveries in this field was the first recognized instance of negative feedback in an organism. Von Uexküll's later work was concerned with the way in which animals experience the world around them. To describe the animal's subjective perception of its environment he introduced the word *Umwelt*; and in 1926 he founded the *Institut für Umweltforschung* at the University of Heidelberg. Von Uexküll visualized an animal - for example a mouse - as being surrounded by a world of its own - the world conveyed by its own special senses organs, and processed by its own interpretative systems. Obviously, the *Umwelt* will differ greatly depending on the organism. For example, bees are able to see polarized light and ultraviolet light; electric eels are able to sense their environment through their electric organs; many insects are extraordinarily sensitive to pheromones; and a dog's *Umwelt* far richer in smells than that of most other animals. The *Umwelt* of a jellyfish is very simple, but nevertheless it exists.² Von Uexküll's *Umwelt* concept can even extend to one-celled organisms, which receive chemical and tactile signals from their environment, and which are often sensitive to light. The ideas and research of Jakob von Uexküll inspired the later work of the Nobel Laureate ethologist Konrad Lorenz, and thus von Uexküll can be thought of as one of the founders of ethology as well as of Biosemiotics. Indeed, ethology and Biosemiotics are closely related.

Biosemiotics also values the ideas of the American anthropologist Gregory Bateson (1904-1980). He was married to another celebrated anthropologist, Margaret Mead, and together they applied Norbert Wiener's insights concerning feedback mechanisms to sociology, psychology and anthropology. Bateson was the originator of a famous epigrammatic definition of information: "...a difference which makes a difference". This definition occurs in Chapter 3 of Bateson's book, *Mind and Nature: A Necessary Unity*, Bantam, (1980), and its context is as follows: "To produce news of a difference, i.e. information", Bateson wrote, "there must be two entities... such that news of their difference can be represented as a difference inside some information-processing entity, such as a brain or, perhaps, a computer. There is a profound and unanswerable question about the nature of these two entities that between them generate the difference which becomes information by making a difference. Clearly each alone is - for the mind and perception - a non-entity, a non-being... the sound of one hand clapping. The stuff of sensation, then, is a pair of values of some variable, presented over time to a sense organ, whose response depends on the ratio between the members of the pair."

7.6 Some personal memories of early computers

I hope that readers will forgive me if I tell them of my own personal memories of early computers:

When I arrived at Imperial College (then part of the University of London) in 1962, I worked with a crystallographic group that using the Mercury computer at University

² It is interesting to ask to what extent the concept of *Umwelt* can be equated to that of consciousness. To the extent that these two concepts can be equated, von Uexküll's *Umweltforschung* offers us the opportunity to explore the phylogenetic evolution of the phenomenon of consciousness.

College to do the calculations needed to arrive at molecular structures. This gave me the chance to use Mercury to do quantum chemical calculations. I used to go over to University College with the crystallographers at night, because time on the computer was so expensive that we could only afford to use it at night. I would make a bed for myself out of three chairs in a row and would try to sleep. At 3 AM or 4 AM they would wake me up and would say “Now it’s your turn”.

Mercury was as big as a house, but could do far less than a modern laptop. It had 50,000 or so vacuum tubes which required cooling. The cooling system sometimes broke down, and one or another of the vacuum tubes sometimes failed, so one had to be grateful for the periods when Mercury was working. Our programs were written on punched tape in a language called CHLF3. (The letters stood for Cambridge, London, Harwell and Farnborough, the four places that had Mercurys). After we had read the paper tape into the computer, the program was converted into a magnetic form on a rapidly rotating drum, and then checked against the original input. If it did not check, we had a so-called “drum parity”, which meant that we had to stop the computer and restart it by hand, using a bewildering array of manual controls.

After finishing the work on Mercury at 6 AM or so, I would walk home, passing through the almost-deserted streets of Soho, and seeing pale-faced teenagers who had been up all night, high on amphetamines. They were sitting on the pavement near an underground station, waiting for it to open.

After we had used Mercury for two years or so, IBM gave Imperial College one of their early computers. Using this was much better. Programs for the IBM machine were written on punched cards. We just went over to the machine with our punched cards and stood in line to have them read into the computer. Then a few minutes later we were handed a printout of the output.

The IBM was much better than the machines that were available in eastern Europe, and for this reason I was contacted by Janos Ladik and his group at the Hungarian Academy of Science, who proposed a collaboration. We worked together for several years, calculating the electronic structure of a number of polypeptides and polynucleotides.

In 1965, Janos Ladik invited me to attend a meeting of quantum theorists and computer scientists from both East and West, held at a town on the Hungarian Puszta, the great Hungarian plain east of Budapest. At the meeting, Enrico Clementi spoke about computer programs that he had developed for performing *ab-initio*³ calculation of the electronic structure of molecules. Clementi was an important IBM scientist, and he had his own laboratory with a large computer which he could use as he liked. The programs that he described to us took hundreds of hours to complete an electronic structure calculation on a single molecule.

In the question period after Clementi’s lecture, someone from the audience said: “It’s all right for you, Clementi. You can use hundreds of hours on a single calculation if you want to, because you are sitting at IBM with your own dedicated computer. But what

³*ab-initio* is a Latin expression meaning “from the beginning”. Such programs are completely free of input parameters based on experiments.



Figure 7.14: **Enrico Clementi (born 1931) explained to us that microminiaturization would soon make computers hundreds of times faster, smaller and less expensive. He was completely right.**

about the rest of us? What good are these programs to us?"

Clementi answered: "In a few years, computers will be hundreds of times faster, and they will also be cheaper." The audience asked: "And how will this happen?". Clementi answered: "Through microminiaturization." He was completely right. That was exactly what happened.

7.7 The invention of transistors

Microelectronics

The problem of unreliable vacuum tubes was solved in 1948 by John Bardeen, William Shockley and Walter Brattain of the Bell Telephone Laboratories. Application of quantum theory to solids had led to an understanding of the electrical properties of crystals. Like atoms, crystals were found to have allowed and forbidden energy levels.

The allowed energy levels for an electron in a crystal were known to form bands, i.e., some energy ranges with many allowed states (allowed bands), and other energy ranges with none (forbidden bands). The lowest allowed bands were occupied by electrons, while higher bands were empty. The highest filled band was called the "valence band", and the lowest empty band was called the "conduction band".

According to quantum theory, whenever the valence band of a crystal is only partly filled, the crystal is a conductor of electricity; but if the valence band is completely filled with electrons, the crystal is an electrical insulator. (A completely filled band is analogous to a room so packed with people that none of them can move.)

In addition to conductors and insulators, quantum theory predicted the existence of

“semiconductors” - crystals where the valence band is completely filled with electrons, but where the energy gap between the conduction band and the valence band is very small. For example, crystals of the elements silicon and germanium are semiconductors. For such a crystal, thermal energy is sometimes enough to lift an electron from the valence band to the conduction band.

Bardeen, Shockley and Brattain found ways to control the conductivity of germanium crystals by injecting electrons into the conduction band, or alternatively by removing electrons from the valence band. They could do this by “doping” the crystals with appropriate impurities, or by injecting electrons with a special electrode. The semiconducting crystals whose conductivity was controlled in this way could be used as electronic valves, in place of vacuum tubes.

By the 1960’s, replacement of vacuum tubes by transistors in electronic computers had led not only to an enormous increase in reliability and a great reduction in cost, but also to an enormous increase in speed. It was found that the limiting factor in computer speed was the time needed for an electrical signal to propagate from one part of the central processing unit to another. Since electrical impulses propagate with the speed of light, this time is extremely small; but nevertheless, it is the limiting factor in the speed of electronic computers.

7.8 The Traitorous Eight

According to the Wikipedia article on Shockley,

“In 1956 Shockley moved from New Jersey to Mountain View, California to start Shockley Semiconductor Laboratory to live closer to his ailing mother in Palo Alto, California. The company, a division of Beckman Instruments, Inc., was the first establishment working on silicon semiconductor devices in what came to be known as Silicon Valley.

“His way [of leading the group] could generally be summed up as domineering and increasingly paranoid. In one well-known incident, he claimed that a secretary’s cut thumb was the result of a malicious act and he demanded lie detector tests to find the culprit, when in reality, the secretary had simply grabbed at a door handle that happened to have an exposed tack on it for the purpose of hanging paper notes on. After he received the Nobel Prize in 1956 his demeanor changed, as evidenced in his increasingly autocratic, erratic and hard-to-please management style. In late 1957, eight of Shockley’s researchers, who would come to be known as the ‘traitorous eight, resigned after Shockley decided not to continue research into silicon-based semiconductors. They went on to form Fairchild Semiconductor, a loss from which Shockley Semiconductor never recovered. Over the course of the next 20 years, more than 65 new enterprises would end up having employee connections back to Fairchild.”

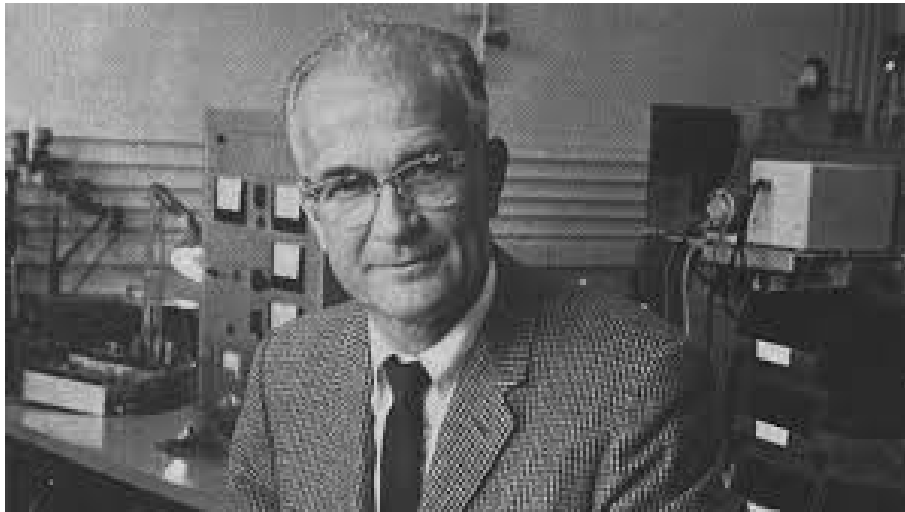

Figure 7.15: **William Shockley (1910-1989) shared the 1956 Nobel Prize in Physics with John Bardeen and Walter Brattain.**



Figure 7.16: **The Traitorous Eight: From left to right, Gordon Moore, C. Sheldon Roberts, Eugene Kleiner, Robert Noyce, Victor Grinich, Julius Blank, Jean Hoerni and Jay Last.**

7.9 Integrated circuits

In order to reduce the propagation time, computer designers tried to make the central processing units very small; and the result was the development of integrated circuits and microelectronics. (Another motive for miniaturization of electronics came from the requirements of space exploration.)

Integrated circuits were developed in which single circuit elements were not manufactured separately. Instead, the whole circuit was made at one time. An integrated circuit is a sandwich-like structure, with conducting, resisting and insulating layers interspersed with layers of germanium or silicon, “doped ” with appropriate impurities. At the start of the manufacturing process, an engineer makes a large drawing of each layer. For example, the drawing of a conducting layer would contain pathways which fill the role played by wires in a conventional circuit, while the remainder of the layer would consist of areas destined to be etched away by acid.

The next step is to reduce the size of the drawing and to multiply it photographically. The pattern of the layer is thus repeated many times, like the design on a piece of wallpaper. The multiplied and reduced drawing is then focused through a reversed microscope onto the surface to be etched.

Successive layers are built up by evaporating or depositing thin films of the appropriate substances onto the surface of a silicon or germanium wafer. If the layer being made is to be conducting, the surface would consist of an extremely thin layer of copper, covered with a photosensitive layer called a “photoresist”. On those portions of the surface receiving light from the pattern, the photoresist becomes insoluble, while on those areas not receiving light, the photoresist can be washed away.

The surface is then etched with acid, which removes the copper from those areas not protected by photoresist. Each successive layer of a wafer is made in this way, and finally the wafer is cut into tiny “chips”, each of which corresponds to one unit of the wallpaper-like pattern.

Although the area of a chip may be much smaller than a square centimeter, the chip can contain an extremely complex circuit. A typical programmable minicomputer or “microprocessor”, manufactured during the 1970’s, could have 30,000 circuit elements, all of which were contained on a single chip. By 1986, more than a million transistors were being placed on a single chip.

As a result of miniaturization, the speed of computers rose steadily. In 1960, the fastest computers could perform a hundred thousand elementary operations in a second. By 1970, the fastest computers took less than a second to perform a million such operations. In 1987, a computer called GF11 was designed to perform 11 billion floating-point operations (flops) per second.

GF11 (Gigaflop 11) is a scientific parallel-processing machine constructed by IBM. Approximately ten floating-point operations are needed for each machine instruction. Thus GF11 runs at the rate of approximately a thousand million instructions per second (1,100 MIPS). The high speed achieved by parallel-processing machines results from dividing a job into many sub-jobs on which a large number of processing units can work simultaneously.

Computer memories have also undergone a remarkable development. In 1987, the magnetic disc memories being produced could store 20 million bits of information per square inch; and even higher densities could be achieved by optical storage devices. (A “bit” is the unit of information. For example, the number 25, written in the binary system, is 11001. To specify this 5-digit binary number requires 5 bits of information. To specify an n -digit binary number requires n bits of information. Eight bits make a “byte”.)

In the 1970's and 1980's, computer networks were set up linking machines in various parts of the world. It became possible (for example) for a scientist in Europe to perform a calculation interactively on a computer in the United States just as though the distant machine were in the same room; and two or more computers could be linked for performing large calculations. It also became possible to exchange programs, data, letters and manuscripts very rapidly through the computer networks.

7.10 Moore's law

In 1965, only four years after the first integrated circuits had been produced, Dr. Gordon E. Moore, one of the founders of Intel, made a famous prediction which has come to be known as “Moore's Law”. He predicted that the number of transistors per integrated circuit would double every two years, and that this trend would continue through 1975. In fact, the general trend predicted by Moore has continued for a much longer time. Although the number of transistors per unit area has not continued to double every two years, the logic density (bits per unit area) has done so, and thus a modified version of Moore's law still holds today. How much longer the trend can continue remains to be seen. Physical limits to miniaturization of transistors of the present type will soon be reached; but there is hope that further miniaturization can be achieved through “quantum dot” technology, molecular switches, and autoassembly.

A typical programmable minicomputer or “microprocessor”, manufactured in the 1970's, could have 30,000 circuit elements, all of which were contained on a single chip. By 1989, more than a million transistors were being placed on a single chip; and by 2000, the number reached 42,000,000.

As a result of miniaturization and parallelization, the speed of computers rose exponentially. In 1960, the fastest computers could perform a hundred thousand elementary operations in a second. By 1970, the fastest computers took less than a second to perform a million such operations. In 1987, a massively parallel computer, with 566 parallel processors, called GF11 was designed to perform 11 billion floating-point operations per second (flops). By 2002 the fastest computer performed 40 at teraflops, making use of 5120 parallel CPU's.

Computer disk storage has also undergone a remarkable development. In 1987, the magnetic disk storage being produced could store 20 million bits of information per square inch; and even higher densities could be achieved by optical storage devices. Storage density has until followed a law similar to Moore's law.

In the 1970's and 1980's, computer networks were set up linking machines in various



Figure 7.17: Gordon E. Moore (born 1929), a founder of Intel and the author of Moore's Law. In 1965 he predicted that the number of components in integrated circuits would double every year for the next 10 years". In 1975 he predicted the this doubling would continue, but revised the doubling rate to "every two years. Astonishingly, Moore's Law has held much longer than he, or anyone else, anticipated.

parts of the world. It became possible (for example) for a scientist in Europe to perform a calculation interactively on a computer in the United States just as though the distant machine were in the same room; and two or more computers could be linked for performing large calculations. It also became possible to exchange programs, data, letters and manuscripts very rapidly through the computer networks.

The exchange of large quantities of information through computer networks was made easier by the introduction of fiber optics cables. By 1986, 250,000 miles of such cables had been installed in the United States. If a ray of light, propagating in a medium with a large refractive index, strikes the surface of the medium at a grazing angle, then the ray undergoes total internal reflection. This phenomenon is utilized in fiber optics: A light signal can propagate through a long, hairlike glass fiber, following the bends of the fiber without losing intensity because of total internal reflection. However, before fiber optics could be used for information transmission over long distances, a technological breakthrough in glass manufacture was needed, since the clearest glass available in 1940 was opaque in lengths more than 10 m. Through studies of the microscopic properties of glasses, the problem of absorption was overcome. By 1987, devices were being manufactured commercially that were capable of transmitting information through fiber-optic cables at the rate of 1.7 billion bits per second.

7.11 Automation

During the last three decades, the cost of computing has decreased exponentially by between twenty and thirty percent per year. Meanwhile, the computer industry has grown exponentially by twenty percent per year (faster than any other industry). The astonishing speed of this development has been matched by the speed with which computers have become part of the fabric of science, engineering, industry, commerce, communications, transport, publishing, education and daily life in the industrialized parts of the world.

The speed, power and accuracy of computers has revolutionized many branches of science. For example, before the era of computers, the determination of a simple molecular structure by the analysis of X-ray diffraction data often took years of laborious calculation; and complicated structures were completely out of reach. In 1949, however, Dorothy Crowfoot Hodgkin used an electronic computer to work out the structure of penicillin from X-ray data. This was the first application of a computer to a biochemical problem; and it was followed by the analysis of progressively larger and more complex structures.

Proteins, DNA, and finally even the detailed structures of viruses were studied through the application of computers in crystallography. The enormous amount of data needed for such studies was gathered automatically by computer-controlled diffractometers; and the final results were stored in magnetic-tape data banks, available to users through computer networks.

The application of quantum theory to chemical problems is another field of science which owes its development to computers. When Erwin Schrödinger wrote down his wave equation in 1926, it became possible, in principle, to calculate most of the physical

and chemical properties of matter. However, the solutions to the Schrödinger equation for many-particle systems can only be found approximately; and before the advent of computers, even approximate solutions could not be found, except for the simplest systems.

When high-speed electronic digital computers became widely available in the 1960's, it suddenly became possible to obtain solutions to the Schrödinger equation for systems of chemical and even biochemical interest. Quantum chemistry (pioneered by such men as J.C. Slater, R.S. Mullikin, D.R. Hartree, V. Fock, J.H. Van Vleck, L. Pauling, E.B. Wilson, P.O. Löwdin, E. Clementi, C.J. Ballhausen and others) developed into a rapidly-growing field, as did solid state physics. Through the use of computers, it became possible to design new materials with desired chemical, mechanical, electrical or magnetic properties. Applying computers to the analysis of reactive scattering experiments, D. Herschbach, J. Polanyi and Y. Lee were able to achieve an understanding of the dynamics of chemical reactions.

The successes of quantum chemistry led Albert Szent-Györgyi, A. and B. Pullman, H. Scheraga and others to pioneer the fields of quantum biochemistry and molecular dynamics. Computer programs for drug design were developed, as well as molecular-dynamics programs which allowed the conformations of proteins to be calculated from a knowledge of their amino acid sequences. Studies in quantum biochemistry have yielded insights into the mechanisms of enzyme action, photosynthesis, active transport of ions across membranes, and other biochemical processes.

In medicine, computers began to be used for monitoring the vital signs of critically ill patients, for organizing the information flow within hospitals, for storing patients' records, for literature searches, and even for differential diagnosis of diseases.

The University of Pennsylvania has developed a diagnostic program called INTERNIST-1, with a knowledge of 577 diseases and their interrelations, as well as 4,100 signs, symptoms and patient characteristics. This program was shown to perform almost as well as an academic physician in diagnosing difficult cases. QMR (Quick Medical Reference), a microcomputer adaptation of INTERNIST-1, incorporates the diagnostic functions of the earlier program, and also offers an electronic textbook mode.

Beginning in the 1960's, computers played an increasingly important role in engineering and industry. For example, in the 1960's, Rolls Royce Ltd. began to use computers not only to design the optimal shape of turbine blades for aircraft engines, but also to control the precision milling machines which made the blades. In this type of computer-assisted design and manufacture, no drawings were required. Furthermore, it became possible for an industry requiring a part from a subcontractor to send the machine-control instructions for its fabrication through the computer network to the subcontractor, instead of sending drawings of the part.

In addition to computer-controlled machine tools, robots were also introduced. They were often used for hazardous or monotonous jobs, such as spray-painting automobiles; and they could be programmed by going through the job once manually in the programming mode. By 1987, the population of robots in the United States was between 5,000 and 7,000, while in Japan, the Industrial Robot Association reported a robot population of 80,000.

Chemical industries began to use sophisticated computer programs to control and to

optimize the operations of their plants. In such control systems, sensors reported current temperatures, pressures, flow rates, etc. to the computer, which then employed a mathematical model of the plant to calculate the adjustments needed to achieve optimum operating conditions.

Not only industry, but also commerce, felt the effects of computerization during the postwar period. Commerce is an information-intensive activity; and in fact some of the crucial steps in the development of information-handling technology developed because of the demands of commerce: The first writing evolved from records of commercial transactions kept on clay tablets in the Middle East; and automatic business machines, using punched cards, paved the way for the development of the first programmable computers.

Computerization has affected wholesaling, warehousing, retailing, banking, stockmarket transactions, transportation of goods - in fact, all aspects of commerce. In wholesaling, electronic data is exchanged between companies by means of computer networks, allowing order-processing to be handled automatically; and similarly, electronic data on prices is transmitted to buyers.

The key to automatic order-processing in wholesaling was standardization. In the United States, the Food Marketing Institute, the Grocery Manufacturers of America, and several other trade organizations, established the Uniform Communications System (UCS) for the grocery industry. This system specifies a standard format for data on products, prices and orders.

Automatic warehouse systems were designed as early as 1958. In such systems, the goods to be stored are placed on pallets (portable platforms), which are stacked automatically in aisles of storage cubicles. A computer records the position of each item for later automatic retrieval.

In retailing, just as in wholesaling, standardization proved to be the key requirement for automation. Items sold in supermarkets in most industrialized countries are now labeled with a standard system of machine-readable thick and thin bars known as the Universal Product Code (UPC). The left-hand digits of the code specify the manufacturer or packer of the item, while the right-hand set of digits specify the nature of the item. A final digit is included as a check, to make sure that the others were read correctly. This last digit (called a modulo check digit) is the smallest number which yields a multiple of ten when added to the sum of the previous digits.

When a customer goes through a check-out line, the clerk passes the purchased items over a laser beam and photocell, thus reading the UPC code into a small embedded computer or microprocessor at the checkout counter, which adds the items to the customer's bill. The microprocessor also sends the information to a central computer and inventory data base. When stocks of an item become low, the central computer generates a replacement order. The financial book-keeping for the retailing operation is also carried out automatically by the central computer.

In many places, a customer passing through the checkout counter of a supermarket is able to pay for his or her purchases by means of a plastic card with a magnetic, machine-readable identification number. The amount of the purchase is then transmitted through a computer network and deducted automatically from the customer's bank account. If the

customer pays by check, the supermarket clerk may use a special terminal to determine whether a check written by the customer has ever “bounced”.

Most checks are identified by a set of numbers written in the Magnetic-Ink Character Recognition (MICR) system. In 1958, standards for the MICR system were established, and by 1963, 85 percent of all checks written in the United States were identified by MICR numbers. By 1968, almost all banks had adopted this system; and thus the administration of checking accounts was automated, as well as the complicated process by which a check, deposited anywhere in the world, returns to the payers bank.

Container ships were introduced in the late 1950's, and since that time, container systems have increased cargo-handling speeds in ports by at least an order of magnitude. Computer networks contributed greatly to the growth of the container system of transportation by keeping track of the position, ownership and contents of the containers.

In transportation, just as in wholesaling and retailing, standardization proved to be a necessary requirement for automation. Containers of a standard size and shape could be loaded and unloaded at ports by specialized tractors and cranes which required only a very small staff of operators. Standard formats for computerized manifests, control documents, and documents for billing and payment, were instituted by the Transportation Data Coordinating Committee, a non-profit organization supported by dues from shipping firms.

In the industrialized parts of the world, almost every type of work has been made more efficient by computerization and automation. Even artists, musicians, architects and authors find themselves making increasing use of computers: Advanced computing systems, using specialized graphics chips, speed the work of architects and film animators. The author's traditional typewriter has been replaced by a word-processor, the composer's piano by a music synthesizer.

In the Industrial Revolution of the 18th and 19th centuries, muscles were replaced by machines. Computerization represents a Second Industrial Revolution: Machines have begun to perform not only tasks which once required human muscles, but also tasks which formerly required human intelligence.

In industrial societies, the mechanization of agriculture has very much reduced the fraction of the population living on farms. For example, in the United States, between 1820 and 1980, the fraction of workers engaged in agriculture fell from 72 percent to 3.1 percent. There are signs that computerization and automation will similarly reduce the number of workers needed in industry and commerce.

Computerization is so recent that, at present, we can only see the beginnings of its impact; but when the Second Industrial Revolution is complete, how will it affect society? When our children finish their education, will they face technological unemployment?

The initial stages of the First Industrial Revolution produced much suffering, because labor was regarded as a commodity to be bought and sold according to the laws of supply and demand, with almost no consideration for the needs of the workers. Will we repeat this mistake? Or will society learn from its earlier experience, and use the technology of automation to achieve widely-shared human happiness?

The Nobel-laureate economist, Wassily W. Leontief, has made the following comment

on the problem of technological unemployment:

“Adam and Eve enjoyed, before they were expelled from Paradise, a high standard of living without working. After their expulsion, they and their successors were condemned to eke out a miserable existence, working from dawn to dusk. The history of technological progress over the last 200 years is essentially the story of the human species working its way slowly and steadily back into Paradise. What would happen, however, if we suddenly found ourselves in it? With all goods and services provided without work, no one would be gainfully employed. Being unemployed means receiving no wages. As a result, until appropriate new income policies were formulated to fit the changed technological conditions, everyone would starve in Paradise.”

To say the same thing in a slightly different way: consider what will happen when a factory which now employs a thousand workers introduces microprocessor-controlled industrial robots and reduces its work force to only fifty. What will the nine hundred and fifty redundant workers do? They will not be able to find jobs elsewhere in industry, commerce or agriculture, because all over the economic landscape, the scene will be the same.

There will still be much socially useful work to be done - for example, taking care of elderly people, beautifying the cities, starting youth centers, planting forests, cleaning up pollution, building schools in developing countries, and so on. These socially beneficial goals are not commercially “profitable”. They are rather the sort of projects which governments sometimes support if they have the funds for it. However, the money needed to usefully employ the nine hundred and fifty workers will not be in the hands of the government. It will be in the hands of the factory owner who has just automated his production line.

In order to make the economic system function again, either the factory owner will have to be persuaded to support socially beneficial but commercially unprofitable projects, or else an appreciable fraction of his profits will have to be transferred to the government, which will then be able to constructively re-employ the redundant workers.

The future problems of automation and technological unemployment may force us to rethink some of our economic ideas. It is possible that helping young people to make a smooth transition from education to secure jobs will become one of the important responsibilities of governments, even in countries whose economies are based on free enterprise. If such a change does take place in the future, while at the same time socialistic countries are adopting a few of the better features of free enterprise, then one can hope that the world will become less sharply divided by contrasting economic systems.

The history of the Internet and World Wide Web

The history of the Internet began in 1961, when Leonard Kleinrock, a student at MIT, submitted a proposal for Ph.D. thesis entitled “Information Flow in Large Communication Nets”. In his statement of the problem, Kleinrock wrote: “The nets under consideration consist of nodes, connected to each other by links. The nodes receive, sort, store, and transmit messages that enter and leave via the links. The links consist of one-way chan-

nels, with fixed capacities. Among the typical systems which fit this description are the Post Office System, telegraph systems, and satellite communication systems.” Kleinrock’s theoretical treatment of package switching systems anticipated the construction of computer networks which would function on a principle analogous to a post office rather than a telephone exchange: In a telephone system, there is a direct connection between the sender and receiver of information. But in a package switching system, there is no such connection - only the addresses of the sender and receiver on the package of information, which makes its way from node to node until it reaches its destination.

Further contributions to the concept of package switching systems and distributed communications networks were made by J.C.R. Licklider and W. Clark of MIT in 1962, and by Paul Baran of the RAND corporation in 1964. Licklider visualized what he called a “Galactic Network”, a globally interconnected network of computers which would allow social interactions and interchange of data and software throughout the world. The distributed computer communication network proposed by Baran was motivated by the desire to have a communication system that could survive a nuclear war. The Cold War had also provoked the foundation (in 1957) of the Advanced Research Projects Agency (ARPA) by the U.S. government as a response to the successful Russian satellite “Sputnik”.

In 1969, a 4-node network was tested by ARPA. It connected computers at the University of California divisions at Los Angeles and Santa Barbara with computers at the Stanford Research Institute and the University of Utah. Describing this event, Leonard Kleinrock said in an interview: “We set up a telephone connection between us and the guys at SRI. We typed the L and we asked on the phone ‘Do you see the L?’ ‘Yes we see the L’, came the response. We typed the 0 and we asked ‘Do you see the 0?’ ‘Yes we see the O.’ Then we typed the G and the system crashed.” The ARPANET (with 40 nodes) performed much better in 1972 at the Washington Hilton Hotel where the participants at a Conference on Computer Communications were invited to test it.

Although the creators of ARPANET visualized it as being used for long- distance computations involving several computers, they soon discovered that social interactions over the Internet would become equally important if not more so. An electronic mail system was introduced in the early 1970’s, and in 1976 Queen Elizabeth II of the United Kingdom became one of the increasing number of e-mail users.

In September, 1973, Robert F. Kahn and Vinton Cerf presented the basic ideas of the Internet at a meeting of the International Network Working Group at the University Sussex in Brighton, England. Among these principles was the rule that the networks to be connected should not be changed internally. Another rule was that if a packet did not arrive at its destination, it would be retransmitted from its original source. No information was to be retained by the gateways used to connect networks; and finally there was to be no global control of the Internet at the operations level.

Computer networks devoted to academic applications were introduced in the 1970’s and 1980’s, both in England, the United States and Japan. The Joint Academic Network (JANET) in the U.K. had its counterpart in the National Science Foundation’s network (NSFNET) in America and Japan’s JUNET (Japan Unix Network). Internet traffic is

Table 7.1: **Historical total world Internet traffic (after Cisco Visual Networking Index Forecast). 1 terrabyte =1,000,000,000,000 bytes**

| year | terabytes per month |
|------|---------------------|
| 1990 | 1 |
| 1991 | 2 |
| 1992 | 4 |
| 1993 | 10 |
| 1994 | 20 |
| 1995 | 170 |
| 1996 | 1,800 |
| 1997 | 5,000 |
| 1998 | 11,000 |
| 1999 | 26,000 |
| 2000 | 75,000 |
| 2001 | 175,000 |
| 2002 | 358,000 |
| 2003 | 681,000 |
| 2004 | 1,267,000 |
| 2005 | 2,055,000 |
| 2006 | 3,339,000 |
| 2007 | 5,219,000 |
| 2008 | 7,639,000 |
| 2009 | 10,676,000 |
| 2010 | 14,984,000 |

approximately doubling each year,⁴ and it is about to overtake voice communication in the volume of information transferred.

In March, 2011, there were more than two billion Internet users in the world. In North America they amounted to 78.3 % of the total population, in Europe 58.3 % and worldwide, 30.2 %. Another index that can give us an impression of the rate of growth of digital data generation and exchange is the “digital universe”, which is defined to be the total volume of digital information that human information technology creates and duplicates in a year. In 2011 the digital universe reached 1.2 zettabytes, and it is projected to quadruple by 2015. A zettabyte is 10^{21} bytes, an almost unimaginable number, equivalent to the information contained in a thousand trillion books, enough books to make a pile that would stretch twenty billion kilometers.

⁴ In the period 1995-1996, the rate of increase was even faster - a doubling every four months

Self-reinforcing information accumulation

Humans have been living on the earth for roughly two million years (more or less, depending on where one draws the line between our human and prehuman ancestors, Table 6.1). During almost all of this time, our ancestors lived by hunting and food-gathering. They were not at all numerous, and did not stand out conspicuously from other animals. Then, suddenly, during the brief space of ten thousand years, our species exploded in numbers from a few million to seven billion (Figure 6.1), populating all parts of the earth, and even setting foot on the moon. This population explosion, which is still going on, has been the result of dramatic cultural changes. Genetically we are almost identical with our hunter-gatherer ancestors, who lived ten thousand years ago, but cultural evolution has changed our way of life beyond recognition.

Beginning with the development of speech, human cultural evolution began to accelerate. It started to move faster with the agricultural revolution, and faster still with the invention of writing and printing. Finally, modern science has accelerated the rate of social and cultural change to a completely unprecedented speed.

The growth of modern science is accelerating because knowledge feeds on itself. A new idea or a new development may lead to several other innovations, which can in turn start an avalanche of change. For example, the quantum theory of atomic structure led to the invention of transistors, which made high-speed digital computers possible. Computers have not only produced further developments in quantum theory; they have also revolutionized many other fields.

The self-reinforcing accumulation of knowledge - the information explosion - which characterizes modern human society is reflected not only in an explosively-growing global population, but also in the number of scientific articles published, which doubles roughly every ten years. Another example is Moore's law - the doubling of the information density of integrated circuits every two years. Yet another example is the explosive growth of Internet traffic shown in Table 7.1.

The Internet itself is the culmination of a trend towards increasing societal information exchange - the formation of a collective human consciousness. This collective consciousness preserves the observations of millions of eyes, the experiments of millions of hands, the thoughts of millions of brains; and it does not die when the individual dies.

7.12 Neural networks

Physiologists have begun to make use of insights derived from computer design in their efforts to understand the mechanism of the brain; and computer designers are beginning to construct computers modeled after neural networks. We may soon see the development of computers capable of learning complex ideas, generalization, value judgements, artistic creativity, and much else that was once thought to be uniquely characteristic of the human mind. Efforts to design such computers will undoubtedly give us a better understanding of the way in which the brain performs its astonishing functions.

Much of our understanding of the nervous systems of higher animals is due to the Spanish microscopist, Ramón y Cajal, and to the English physiologists, Alan Hodgkin and Andrew Huxley. Cajal's work, which has been confirmed and elaborated by modern electron microscopy, showed that the central nervous system is a network of nerve cells (neurons) and threadlike fibers growing from them. Each neuron has many input fibers (dendrites), and one output fiber (the axon), which may have several branches.

It is possible the computers of the future will have pattern-recognition and learning abilities derived from architecture inspired by our understanding of the synapse, by Young's model, or by other biological models. However, pattern recognition and learning can also be achieved by programming, using computers of conventional architecture. Programs already exist which allow computers to understand both handwriting and human speech; and a recent chess-playing program was able to learn by studying a large number of championship games. Having optimized its parameters by means of this learning experience, the chess-playing program was able to win against grand masters!

Like nuclear physics and genesplicing, artificial intelligence presents a challenge: Will society use its new powers wisely and humanely? The computer technology of the future can liberate us from dull and repetitive work, and allow us to use our energies creatively; or it can produce unemployment and misery, depending on how we organize our society. Which will we choose?

The merging of information technology and biotechnology

Information technology and biology are today the two most rapidly developing fields of science. Interestingly, these two fields seem to be merging, each gaining inspiration and help from the other. For example, computer scientists designing both hardware and software are gaining inspiration from physiological studies of the mechanism of the brain; and conversely, neurophysiologists are aided by insights from the field of artificial intelligence. Designers of integrated circuits wish to prolong the period of validity of Moore's law; but they are rapidly approaching physical barriers which will set limits to the miniaturization of conventional transistors and integrated circuits. They gain inspiration from biology, where the language of molecular complementarity and the principle of autoassembly seem to offer hope that molecular switches and self-assembled integrated circuits may one day be constructed.

Geneticists, molecular biologists, biochemists and crystallographers have now obtained so much information about the amino acid sequences and structures of proteins and about the nucleotide sequences in genomes that the full power of modern information technology is needed to store and to analyze this information. Computer scientists, for their part, turn to evolutionary genetics for new and radical methods of developing both software and hardware - genetic algorithms and simulated evolution.

Self-assembly of supramolecular structures; Nanoscience

One of the best studied examples of autoassembly through the mechanism of molecular complementarity is the tobacco mosaic virus. The assembled virus has a cylindrical form about 300 nm long (1 nm = 1 nanometer = 10^{-9} meters = 10 Ångstroms), with a width of 18 nm. The cylindrically shaped virus is formed from about 2000 identical protein molecules. These form a package around an RNA molecule with a length of approximately 6400 nucleotides. The tobacco mosaic virus can be decomposed into its constituent molecules *in vitro*, and the protein and RNA can be separated and put into separate bottles.

If, at a later time, one mixes the protein and RNA molecules together in solution, they spontaneously assemble themselves into new infective tobacco mosaic virus particles. The mechanism for this spontaneous autoassembly is a random motion of the molecules through the solvent until they approach each other in such a way that a fit is formed. When two molecules fit closely together, with their physical contours matching, and with complementary patterns of excess charge also matching, the Gibbs free energy of the total system is minimized. Thus the self-assembly of matching components proceeds spontaneously, just as every other chemical reaction proceeds spontaneously when the difference in Gibbs free energy between the products and reactants is negative. The process of autoassembly is analogous to crystallization, except that the structure formed is more complex than an ordinary crystal.

A second very well-studied example of biological autoassembly is the spontaneous formation of bilayer membranes when phospholipid molecules are shaken together in water. Each phospholipid molecule has a small polar (hydrophilic) head, and a long nonpolar (hydrophobic) tail. The polar head is hydrophilic - water-loving - because it has large excess charges with which water can form hydrogen bonds. By contrast, the non-polar tail of a phospholipid molecule has no appreciable excess charges. The tail is hydrophobic - it hates water - because to fit into the water structure it has to break many hydrogen bonds to make a hole for itself, but it cannot pay for these broken bonds by forming new hydrogen bonds with water.

There is a special configuration of the system of water and phospholipid molecules which has a very low Gibbs free energy - the lipid bilayer. In this configuration, all the hydrophilic polar heads are in contact with water, while the hydrophobic nonpolar tails are in the interior of the double membrane, away from the water, and in close contact with each other, thus maximizing their mutual Van der Waals attractions. (The basic structure of biological membranes is the lipid bilayer just described, but there are also other components, such as membrane-bound proteins, caveolae, and ion pores.)

The mechanism of self-organization of supramolecular structures is one of the most important universal mechanisms of biology. Chemical reactions take place spontaneously when the change in Gibbs free energy produced by the reaction is negative, i.e., chemical reactions take place in such a direction that the entropy of the universe increases. When spontaneous chemical reactions take place, the universe moves from a less probable configuration to a more probable one. The same principle controls the motion of larger systems, where molecules arrange themselves spontaneously to form supramolecular struc-

tures. Self-assembling collections of molecules move in such a way as to minimize their Gibbs free energy, thus maximizing the entropy of the universe.

Biological structures of all kinds are formed spontaneously from their components because assembly information is written onto their joining surfaces in the form of complementary surface contours and complementary patterns of excess charge⁵. Matching pieces fit together, and the Gibbs free energy of the system is minimized. Virtually every structure observed in biology is formed in this way - by a process analogous to crystallization, except that biological structures can be far more complex than ordinary crystals.

Researchers in microelectronics, inspired by the self-assembly of biological structures, dream of using the same principles to generate self-organizing integrated circuits with features so small as to approach molecular dimensions. The speed of a computing operation is limited by the time that it takes an electrical signal (moving at approximately the speed of light) to traverse a processing unit. The desire to produce ever greater computation speeds as well as ever greater memory densities, motivates the computer industry's drive towards ultraminiaturization.

Currently the fineness of detail in integrated circuits is limited by diffraction effects caused by the finite wavelength of the light used to project an image of the circuit onto a layer of photoresist covering the chip where the circuit is being built up. For this reason, there is now very active research on photolithography using light sources with extremely short wavelengths, in the deep ultraviolet, or even X-ray sources, synchrotron radiation, or electron beams. The aim of this research is to produce integrated circuits whose feature size is in the nanometer range - smaller than 100 nm. In addition to these efforts to create nanocircuits by "top down" methods, intensive research is also being conducted on "bottom up" synthesis, using principles inspired by biological self-assembly. The hope to make use of "the spontaneous association of molecules, under equilibrium conditions, into stable, structurally well-defined aggregates, joined by non-covalent bonds"⁶

The Nobel Laureate Belgian chemist J.-M. Lehn pioneered the field of supramolecular chemistry by showing that it is possible to build nanoscale structures of his own design. Lehn and his coworkers at the University of Strasbourg used positively-charged metal ions as a kind of glue to join larger structural units at points where the large units exhibited excess negative charges. Lehn predicts that the supramolecular chemistry of the future will follow the same principles of self-organization which underlie the growth of biological structures, but with a greatly expanded repertory, making use of elements (such as silicon) that are not common in carbon-based biological systems.

Other workers in nanotechnology have concentrated on the self-assembly of two-dimensional structures at water-air interfaces. For example, Thomas Bjørnholm, working at the University of Copenhagen, has shown that a nanoscale wire can be assembled spontaneously at a water-air interface, using metal atoms complexed with DNA and a DNA template. The use of a two-dimensional template to reproduce a nanostructure can be thought of as "microprinting". One can also think of self-assembly at surfaces as the two-dimensional version

⁵ Patterns of reactive or polarizable groups also play a role.

⁶ G.M. Whiteside et al., *Science*, **254**, 1312-1314, (1991).

of the one-dimensional copying process by which a new DNA or RNA strand assembles itself spontaneously, guided by the complementary strand.

In 1981, Gerd Binnig and Heinrich Rohrer of IBM's Research Center in Switzerland announced their invention of the scanning tunneling microscope. The new microscope's resolution was so great that single atoms could be observed. The scanning tunneling microscope consists of a supersharp conducting tip, which is brought near enough to a surface so that quantum mechanical tunneling of electrons can take place between tip and surface when a small voltage is applied. The distance between the supersharp tip and the surface is controlled by means of a piezoelectric crystal. As the tip is moved along the surface, its distance from the surface (and hence the tunneling current) is kept constant by applying a voltage to the piezoelectric crystal, and this voltage as a function of position gives an image of the surface.

Variations on the scanning tunneling microscope allow single atoms to be deposited or manipulated on a surface. Thus there is a hope that nanoscale circuit templates can be constructed by direct manipulation of atoms and molecules, and that the circuits can afterwards be reproduced using autoassembly mechanisms.

The scanning tunneling microscope makes use of a quantum mechanical effect: Electrons exhibit wavelike properties, and can tunnel small distances into regions of negative kinetic energy - regions which would be forbidden to them by classical mechanics. In general it is true that for circuit elements with feature sizes in the nanometer range, quantum effects become important. For conventional integrated circuits, the quantum effects which are associated with this size-range would be a nuisance, but workers in nanotechnology hope to design integrated circuits which specifically make use of these quantum effects.

Molecular switches; bacteriorhodopsin

The purple, salt-loving archaebacterium *Halobacterium halobium* (recently renamed *Halobacterium salinarum*) possesses one of the simplest structures that is able to perform photosynthesis. The purple membrane subtraction of this bacterium's cytoplasmic membrane contains only two kinds of molecules - lipids and bacteriorhodopsin. Nevertheless, this simple structure is able to trap the energy of a photon from the sun and to convert it into chemical energy.

The remarkable purple membrane of *Halobacterium* has been studied in detail by Walter Stoeckenius, D. Osterhelt⁷, Lajos Keszthelyi and others.

It can be decomposed into its constituent molecules. The lipids from the membrane and the bacteriorhodopsin can be separated from each other and put into different bottles. At a later time, the two bottles can be taken from the laboratory shelf, and their contents can be shaken together in water. The result is the spontaneous formation of tiny vesicles of purple membrane.

⁷ D. Osterhelt and Walter Stoeckenius, *Nature New Biol.* **233**, 149-152 (1971); D. Osterhelt et al., *Quart. Rev. Biophys.* **24**, 425-478 (1991); W. Stoeckenius and R. Bogomolni, *Ann. Rev. Biochem.* **52**, 587-616 (1982).

In the self-organized two-component vesicles, the membrane-bound protein bacteriorhodopsin is always correctly oriented, just as it would be in the purple membrane of a living *Halobacterium*. When the vesicles are illuminated, bacteriorhodopsin absorbs H^+ ions from the water on the inside, and releases them outside.

Bacteriorhodopsin consists of a chain of 224 amino acids, linked to the retinal chromophore. The amino acids are arranged in 7 helical segments, each of which spans the purple membrane, and these are joined on the membrane surface by short nonhelical segments of the chain. The chromophore is in the middle of the membrane, surrounded by α -helical segments. When the chromophore is illuminated, its color is temporarily bleached, and it undergoes a *cis-trans* isomerization which disrupts the hydrogen-bonding network of the protein. The result is that a proton is released on the outside of the membrane. Later, a proton is absorbed from the water in the interior of the membrane vesicle, the hydrogen-bonding system of the protein is reestablished, and both the protein and the chromophore return to their original conformations. In this way, bacteriorhodopsin functions as a proton pump. It uses the energy of photons to transport H^+ ions across the membrane, from the inside to the outside, against the electrochemical gradient. In the living *Halobacterium*, this H^+ concentration difference would be used to drive the synthesis of the high-energy phosphate bond of adenosine triphosphate (ATP), the inward passage of H^+ through other parts of the cytoplasmic membrane being coupled to the reaction $ADP + P_i \rightarrow ATP$ by membrane-bound reversible ATPase.

Bacteriorhodopsin is interesting as a component of one of the simplest known photosynthetic systems, and because of its possible relationship to the evolution of the eye. In addition, researchers like Lajos Keszthelyi at the Institute of Biophysics of the Hungarian Academy of Sciences in Szeged are excited about the possible use of bacteriorhodopsin in optical computer memories⁸. Arrays of oriented and partially dehydrated bacteriorhodopsin molecules in a plastic matrix can be used to construct both 2-dimensional and 3-dimensional optical memories using the reversible color changes of the molecule. J. Chen and coworkers⁹ have recently constructed a prototype 3-dimensional optical memory by orienting the proteins and afterwards polymerizing the solvent into a solid polyacrylamide matrix. Bacteriorhodopsin has extraordinary stability, and can tolerate as many as a million optical switching operations without damage.

Neural networks, biological and artificial

In 1943, W. McCulloch and W. Pitts published a paper entitled *A Logical Calculus of the Ideas Immanent in Nervous Activity*. In this pioneering paper, they proposed the idea of a Threshold Logic Unit (TLU), which they visualized not only as a model of the way in which neurons function in the brain but also as a possible subunit for artificial systems which might be constructed to perform learning and pattern-recognition tasks. Problems involving learning, generalization, pattern recognition and noisy data are easily handled

⁸ A. Der and L. Keszthelyi, editors, *Bioelectronic Applications of Photochromic Pigments*, IOS Press, Amsterdam, Netherlands, (2001).

⁹ J. Chen et al., *Biosystems* **35**, 145-151 (1995).

by the brains of humans and animals, but computers of the conventional von Neumann type find such tasks especially difficult.

Conventional computers consist of a memory and one or more central processing units (CPUs). Data and instructions are repeatedly transferred from the memory to the CPUs, where the data is processed and returned to the memory. The repeated performance of many such cycles requires a long and detailed program, as well as high-quality data. Thus conventional computers, despite their great speed and power, lack the robustness, intuition, learning powers and powers of generalization which characterize biological neural networks. In the 1950's, following the suggestions of McCulloch and Pitts, and inspired by the growing knowledge of brain structure and function which was being gathered by histologists and neurophysiologists, computer scientists began to construct artificial neural networks - massively parallel arrays of TLU's.

The analogy between a TLU and a neuron can be seen by comparing Figure 5.2, which shows a neuron, with Figure 8.1, which shows a TLU. A neuron is a specialized cell consisting of a cell body (*soma*) from which an extremely long, tubelike fiber called an *axon* grows. The axon is analogous to the output channel of a TLU. From the soma, a number of slightly shorter, rootlike extensions called *dendrites* also grow. The dendrites are analogous to the input channels of a TLU.

In a biological neural network, branches from the axon of a neuron are connected to the dendrites of many other neurons; and at the points of connection there are small, knoblike structures called synapses. The "firing" of a neuron sends a wave of depolarization out along its axon. When the pulselike electrical and chemical disturbance associated with the wave of depolarization (the action potential) reaches a synapse, where the axon is connected with another neuron, transmitter molecules are released into the post-synaptic cleft. The neurotransmitter molecules travel across the post-synaptic cleft to receptors on a dendrite of the next neuron in the net, where they are bound to receptors. There are many kinds of neurotransmitter molecules, some of which tend to make the firing of the next neuron more probable, and others which tend to inhibit its firing. When the neurotransmitter molecules are bound to the receptors, they cause a change in the dendritic membrane potential, either increasing or decreasing its polarization. The post-synaptic potentials from the dendrites are propagated to the soma; and if their sum exceeds a threshold value, the neuron fires. The subtlety of biological neural networks derives from the fact that there are many kinds of neurotransmitters and synapses, and from the fact that synapses are modified by their past history.

Turning to Figure 8.1, we can compare the biological neuron with the Threshold Logic Unit of McCulloch and Pitts. Like the neuron, the TLU has many input channels. To each of the N channels there is assigned a weight, w_1, w_2, \dots, w_N . The weights can be changed; and the set of weights gives the TLU its memory and learning capabilities. Modification of weights in the TLU is analogous to the modification of synapses in a neuron, depending on their history. In the most simple type of TLU, the input signals are either 0 or 1. These signals, multiplied by their appropriate weights, are summed, and if the sum exceeds a threshold value, θ the TLU "fires", i.e. a pulse of voltage is transmitted through the output channel to the next TLU in the artificial neural network.

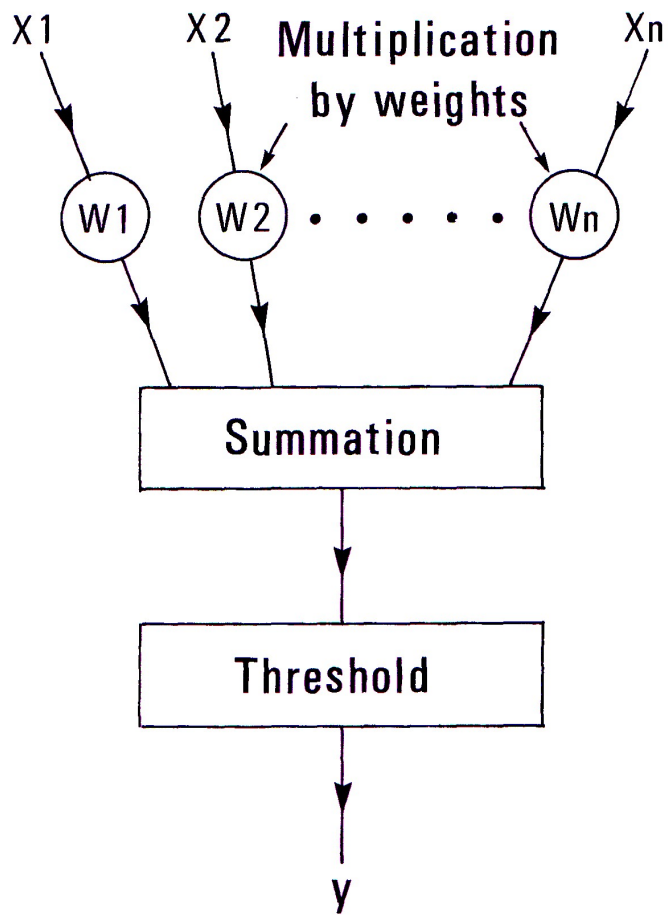

Figure 7.20: A Threshold Logic Unit (TLU) of the type proposed by McCulloch and Pitts.

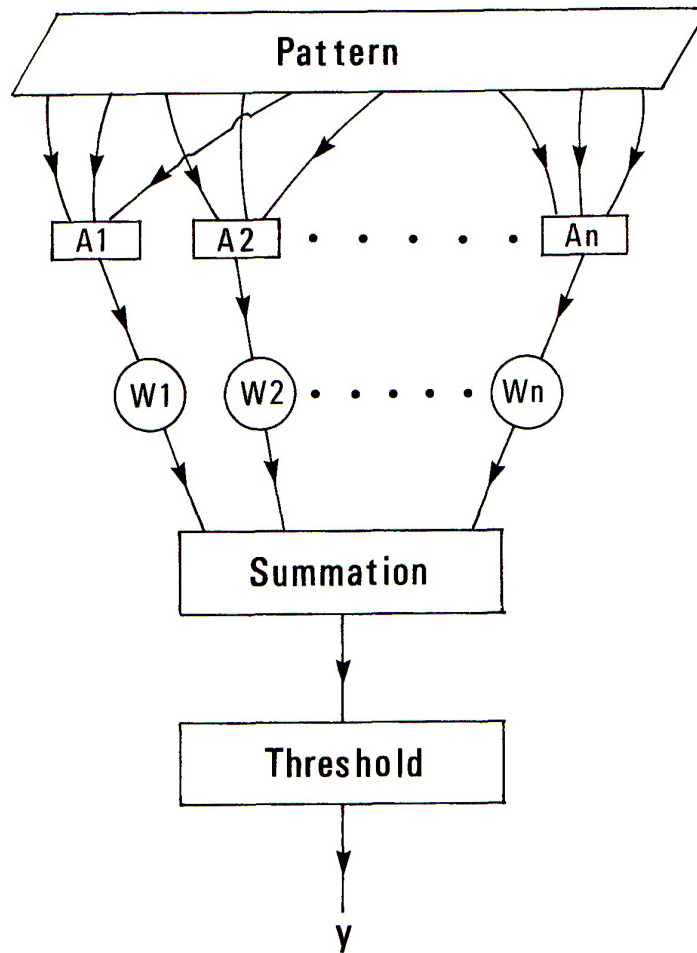

Figure 7.21: A perceptron, introduced by Rosenblatt in 1962. The perceptron is similar to a TLU, but its input is preprocessed by a set of association units (A-units). The A-units are not trained, but are assigned a fixed Boolean functionality.

Let us imagine that the input signals, x_1, x_2, \dots, x_N can take on the values 0 or 1. The weighted sum of the input signals will then be given by

$$a = \sum_{j=1}^N w_j x_j \quad (7.1)$$

The quantity a , is called the *activation*. If the activation exceeds the threshold θ , the unit “fires”, i.e. it produces an output y given by

$$y = \begin{cases} 1 & \text{if } a \geq \theta \\ 0 & \text{if } a < \theta \end{cases} \quad (7.2)$$

The decisions taken by a TLU can be given a geometrical interpretation: The input signals can be thought of as forming the components of a vector, $\mathbf{x} = x_1, x_2, \dots, x_N$, in an N -dimensional space called pattern space. The weights also form a vector, $\mathbf{w} = w_1, w_2, \dots, w_N$, in the same space. If we write an equation setting the scalar product of these two vectors equal to some constant,

$$\mathbf{w} \cdot \mathbf{x} \equiv \sum_{j=1}^N w_j x_j = \theta \quad (7.3)$$

then this equation defines a hyperplane in pattern space, called the *decision hyperplane*. The decision hyperplane divides pattern space into two parts - (1) input pulse patterns which will produce firing of the TLU, and (2) patterns which will not cause firing.

The position and orientation of the decision hyperplane can be changed by altering the weight vector \mathbf{w} and/or the threshold θ . Therefore it is convenient to put the threshold and the weights on the same footing by introducing an augmented weight vector,

$$\mathbf{W} = w_1, w_2, \dots, w_N, \theta \quad (7.4)$$

and an augmented input pattern vector,

$$\mathbf{X} = x_1, x_2, \dots, x_N, -1 \quad (7.5)$$

In the $N+1$ -dimensional augmented pattern space, the decision hyperplane now passes through the origin, and equation (7.3) can be rewritten in the form

$$\mathbf{W} \cdot \mathbf{X} \equiv \sum_{j=1}^{N+1} W_j X_j = 0 \quad (7.6)$$

Those input patterns for which the scalar product $\mathbf{W} \cdot \mathbf{X}$ is positive or zero will cause the unit to fire, but if the scalar product is negative, there will be no response.

If we wish to “teach” a TLU to fire when presented with a particular pattern vector \mathbf{X} , we can evaluate its scalar product with the current augmented weight vector \mathbf{W} . If this

scalar product is negative, the TLU will not fire, and therefore we know that the weight vector needs to be changed. If we replace the weight vector by

$$\mathbf{W}' = \mathbf{W} + \gamma \mathbf{X} \quad (7.7)$$

where γ is a small positive number, then the new augmented weight vector \mathbf{W}' will point in a direction more nearly the same as the direction of \mathbf{X} . This change will be a small step in the direction of making the scalar product positive, i.e. a small step in the right direction.

Why not take a large step instead of a small one? A small step is best because there may be a whole class of input patterns to which we would like the TLU to respond by firing. If we make a large change in weights to help a particular input pattern, it may undo previous learning with respect to other patterns.

It is also possible to teach a TLU to remain silent when presented with a particular input pattern vector. To do so we evaluate the augmented scalar product $\mathbf{W} \cdot \mathbf{X}$ as before, but now, when we desire silence rather than firing, we wish the scalar product to be negative, and if it is positive, we know that the weight vector must be changed. In changing the weight vector, we can again make use of equation (8.7), but now γ must be a small negative number rather than a small positive one.

Two sets of input patterns, A and B, are said to be linearly separable if they can be separated by some decision hyperplane in pattern space. Now suppose that the four sets, A, B, C, and D, can be separated by two decision hyperplanes. We can then construct a two-layer network which will identify the class of an input signal belonging to any one of the sets, as is illustrated in Figure 8.2.

The first layer consists of two TLU's. The first TLU in this layer is taught to fire if the input pattern belongs to A or B, and to be silent if the input belongs to C or D. The second TLU is taught to fire if the input pattern belongs to A or D, and to be silent if it belongs to B or C. The second layer of the network consists of four output units which are not taught, but which are assigned a fixed Boolean functionality. The first output unit fires if the signals from the first layer are given by the vector $\mathbf{y} = \{0, 0\}$ (class A); the second fires if $\mathbf{y} = \{0, 1\}$ (class B), the third if $\mathbf{y} = \{1, 0\}$ (class C), and the fourth if $\mathbf{y} = \{1, 1\}$ (class D). Thus the simple two-layer network shown in Figure 8.2 functions as a *classifier*. The output units in the second layer are analogous to the "grandmother's face cells" whose existence in the visual cortex is postulated by neurophysiologists. These cells will fire if and only if the retina is stimulated with a particular class of patterns.

This very brief glance at artificial neural networks does not do justice to the high degree of sophistication which network architecture and training algorithms have achieved during the last two decades. However, the suggestions for further reading at the end of this chapter may help to give the reader an impression of the wide range of problems to which these networks are now being applied.

Besides being useful for computations requiring pattern recognition, learning, generalization, intuition, and robustness in the face of noisy data, artificial neural networks are important because of the light which they throw on the mechanism of brain function. For

example, one can compare the classifier network shown in Figure 8.2 with the discoveries of Kuffler, Hubel and Wessel concerning pattern abstraction in the mammalian retina and visual cortex.

Genetic algorithms

Genetic algorithms represent a second approach to machine learning and to computational problems involving optimization. Like neural network computation, this alternative approach has been inspired by biology, and it has also been inspired by the Darwinian concept of natural selection. In a genetic algorithm, the hardware is that of a conventional computer; but the software creates a population and allows it to evolve in a manner closely analogous to biological evolution.

One of the most important pioneers of genetic algorithms was John Henry Holland (1929-). After attending MIT, where he was influenced by Norbert Wiener, Holland worked for IBM, helping to develop the 701. He then continued his studies at the University of Michigan, obtaining the first Ph.D. in computer science ever granted in America. Between 1962 and 1965, Holland taught a graduate course at Michigan called "Theory of Adaptive Systems". His pioneering course became almost a cult, and together with his enthusiastic students he applied the genetic algorithm approach to a great variety of computational problems. One of Holland's students, David Goldberg, even applied a genetic algorithm program to the problem of allocating natural gas resources.

The programs developed by Holland and his students were modelled after the natural biological processes of reproduction, mutation, selection and evolution. In biology, the information passed between generations is contained in chromosomes - long strands of DNA where the genetic message is written in a four-letter language, the letters being adenine, thymine, guanine and cytosine. Analogously, in a genetic algorithm, the information is coded in a long string, but instead of a four-letter language, the code is binary: The chromosome-analogue is a long string of 0's and 1's, i.e., a long binary string. One starts with a population that has sufficient diversity so that natural selection can act.

The genotypes are then translated into phenotypes. In other words, the information contained in the long binary string (analogous to the genotype of each individual) corresponds to an entity, the phenotype, whose fitness for survival can be evaluated. The mapping from genotype to phenotype must be such that very small changes in the binary string will not produce radically different phenotypes. From the initial population, the most promising individuals are selected to be the parents of the next generation, and of these, the fittest are allowed produce the largest number of offspring. Before reproduction takes place, however, random mutations and chromosome crossing can occur. For example, in chromosome crossing, the chromosomes of two individuals are broken after the n th binary digit, and two new chromosomes are formed, one with the head of the first old chromosome and the tail of the second, and another with the head of the second and the tail of the first. This process is analogous to the biological crossings which allowed Thomas Hunt Morgan and his "fly squad" to map the positions of genes on the chromosomes of fruit flies, while the mutations are analogous to those studied by Hugo de Vries and Hermann

J. Muller.

After the new generation has been produced, the genetic algorithm advances the time parameter by a step, and the whole process is repeated: The phenotypes of the new generation are evaluated and the fittest selected to be parents of the next generation; mutation and crossings occur; and then fitness-proportional reproduction. Like neural networks, genetic algorithms are the subject of intensive research, and evolutionary computation is a rapidly growing field.

Evolutionary methods have been applied not only to software, but also to hardware. Some of the circuits designed in this way defy analysis using conventional techniques - and yet they work astonishingly well.

Artificial life

As Aristotle pointed out, it is difficult to define the precise border between life and nonlife. It is equally difficult to give a precise definition of artificial life. Of course the term means “life produced by humans rather than by nature”, but what is life? Is self-replication the only criterion? The phrase “produced by humans” also presents difficulties. Humans have played a role in creating domestic species of animals and plants. Can cows, dogs, and high-yield wheat varieties be called “artificial life”? In one sense, they can. These species and varieties certainly would not have existed without human intervention.

We come nearer to what most people might call “artificial life” when we take parts of existing organisms and recombine them in novel ways, using the techniques of biotechnology. For example, Steen Willadsen¹⁰, working at the Animal Research Station, Cambridge England, was able to construct chimeras by operating under a microscope on embryos at the eight-cell stage. The zona pelucida is a transparent shell that surrounds the cells of the embryo. Willadsen was able to cut open the zona pelucida, to remove the cells inside, and to insert a cell from a sheep embryo together with one from a goat embryo. The chimeras which he made in this way were able to grow to be adults, and when examined, their cells proved to be a mosaic, some cells carrying the sheep genome while others carried the genome of a goat. By the way, Willadsen did not create his chimeras in order to produce better animals for agriculture. He was interested in the scientifically exciting problem of morphogenesis: How is the information of the genome translated into the morphology of the growing embryo?

Human genes are now routinely introduced into embryos of farm animals, such as pigs or sheep. The genes are introduced into regulatory sequences which cause expression in mammary tissues, and the adult animals produce milk containing human proteins. Many medically valuable proteins are made in this way. Examples include human blood-clotting factors, interleukin-2 (a protein which stimulates T-lymphocytes), collagen and fibrinogen (used to treat burns), human fertility hormones, human hemoglobin, and human serum albumin.

¹⁰ Willadsen is famous for having made the first verified and reproducible clone of a mammal. In 1984 he made two genetically identical lambs from early sheep embryo cells.

Transgenic plants and animals in which the genes of two or more species are inherited in a stable Mendelian way have become commonplace in modern laboratory environments, and, for better or for worse, they are also becoming increasingly common in the external global environment. These new species might, with some justification, be called “artificial life”.

A long period of molecular evolution probably preceded the evolution of cells. In the early 1970's, S. Spiegelman performed a series of experiments in which he demonstrated that artificial molecular evolution can be made to take place *in vitro*. Spiegelman prepared a large number of test tubes in which RNA replication could take place. The aqueous solution in each of the test tubes consisted of RNA replicase, ATP, UTP (uracil triphosphate), GTP (guanine triphosphate), CTP (cytosine triphosphate) and buffer. He then introduced RNA from a bacteriophage into the first test tube. After a predetermined interval of time, during which replication took place, Spiegelman transferred a drop of solution from the first test tube to a new tube, uncontaminated with RNA. Once again, replication began and after an interval a drop was transferred to a third test tube. Spiegelman repeated this procedure several hundred times, and at the end he was able to demonstrate that the RNA in the final tube differed from the initial sample, and that it replicated faster than the initial sample. The RNA had evolved by the classical Darwinian mechanisms of mutation and natural selection. Mistakes in copying had produced mutant RNA strands which competed for the supply of energy-rich precursor molecules (ATP, UTP, GTP and CTP). The most rapidly-reproducing mutants survived. Was Spiegelman's experiment merely a simulation of an early stage of biological evolution? Or was evolution of an extremely primitive life-form actually taking place in his test tubes?

G.F. Joyce, D.P. Bartel and others have performed experiments in which strands of RNA with specific catalytic activity (ribozymes) have been made to evolve artificially from randomly coded starting populations of RNA. In these experiments, starting populations of 10¹³ to 10¹⁵ randomly coded RNA molecules are tested for the desired catalytic activity, and the most successful molecules are then chosen as parents for the next generation. The selected molecules are replicated many times, but errors (mutations) sometimes occur in the replication. The new population is once again tested for catalytic activity, and the process is repeated. The fact that artificial evolution of ribozymes is possible can perhaps be interpreted as supporting the “RNA world” hypothesis, i.e. the hypothesis that RNA preceded DNA and proteins in the early history of terrestrial life.

John von Neumann speculated on the possibility of constructing artificial self-reproducing automata. In the early 1940's, a period when there was much discussion of the Universal Turing Machine, he became interested in constructing a mathematical model of the requirements for self-reproduction. Besides the Turing machine, another source of his inspiration was the paper by Warren McCulloch and Walter Pitts entitled *A logical calculus of the ideas immanent in nervous activity*, which von Neumann read in 1943. In his first attempt (the kinematic model), he imagined an extremely large and complex automaton, floating on a lake which contained its component parts.

Von Neumann's imaginary self-reproducing automaton consisted of four units, A, B, C and D. Unit A was a sort of factory, which gathered component parts from the surrounding

lake and assembled them according to instructions which it received from other units. Unit B was a copying unit, which reproduced sets of instructions. Unit C was a control apparatus, similar to a computer. Finally D was a long string of instructions, analogous to the “tape” in the Turing machine. In von Neumann’s kinematic automaton, the instructions were coded as a long binary number. The presence of what he called a “girder” at a given position corresponded to 1, while its absence corresponded to 0. In von Neumann’s model, the automaton completed the assembly of its offspring by injecting its progeny with the duplicated instruction tape, thus making the new automaton both functional and fertile.

In presenting his kinematic model at the Hixton Symposium (organized by Linus Pauling in the late 1940’s), von Neumann remarked that “...it is clear that the instruction [tape] is roughly effecting the function of a gene. It is also clear that the copying mechanism B performs the fundamental act of reproduction, the duplication of the genetic material, which is clearly the fundamental operation in the multiplication of living cells. It is also easy to see how arbitrary alterations of the system...can exhibit certain traits which appear in connection with mutation, lethality as a rule, but with a possibility of continuing reproduction with a modification of traits.”

It is very much to von Neumann’s credit that his kinematic model (which he invented several years before Crick and Watson published their DNA structure) was organized in much the same way that we now know the reproductive apparatus of a cell to be organized. Nevertheless he was dissatisfied with the model because his automaton contained too many “black boxes”. There were too many parts which were supposed to have certain functions, but for which it seemed very difficult to propose detailed mechanisms by which the functions could be carried out. His kinematic model seemed very far from anything which could actually be built¹¹.

Von Neumann discussed these problems with his close friend, the Polish-American mathematician Stanislaw Ulam, who had for a long time been interested in the concept of self-replicating automata. When presented with the black box difficulty, Ulam suggested that the whole picture of an automaton floating on a lake containing its parts should be discarded. He proposed instead a model which later came to be known as the Cellular Automaton Model. In Ulam’s model, the self-reproducing automaton lives in a very special space. For example, the space might resemble an infinite checkerboard, each square would constitute a multi-state cell. The state of each cell in a particular time interval is governed by the states of its near neighbors in the preceding time interval according to relatively simple laws. The automaton would then consist of a special configuration of cell states, and its reproduction would correspond to production of a similar configuration of cell states in a neighboring region of the cell lattice.

Von Neumann liked Ulam’s idea, and he began to work in that direction. However, he

¹¹ Von Neumann’s kinematic automaton was taken seriously by the Mission IV Group, part of a ten-week program sponsored by NASA in 1980 to study the possible use of advanced automation and robotic devices in space exploration. The group, headed by Richard Laing, proposed plans for self-reproducing factories, designed to function on the surface of the moon or the surfaces of other planets. Like von Neumann’s kinetic automaton, to which they owed much, these plans seemed very far from anything that could actually be constructed.

wished his self-replicating automaton to be able to function as a universal Turing machine, and therefore the plans which he produced were excessively complicated. In fact, von Neumann believed complexity to be a necessary requirement for self-reproduction. In his model, the cells in the lattice were able to have 29 different states, and the automaton consisted of a configuration involving hundreds of thousands of cells. Von Neumann's manuscript on the subject became longer and longer, and he did not complete it before his early death from prostate cancer in 1957. The name "cellular automaton" was coined by Arthur Burks, who edited von Neumann's posthumous papers on the theory of automata.

Arthur Burks had written a Ph.D. thesis in philosophy on the work of the nineteenth century thinker Charles Sanders Peirce, who is today considered to be one of the founders of semiotics¹². He then studied electrical engineering at the Moore School in Philadelphia, where he participated in the construction of ENIAC, one of the first general purpose electronic digital computers, and where he also met John von Neumann. He worked with von Neumann on the construction of a new computer, and later Burks became the leader of the Logic of Computers Group at the University of Michigan. One of Burks' students at Michigan was John Holland, the pioneer of genetic algorithms. Another student of Burks, E.F. Codd, was able to design a self-replicating automaton of the von Neumann type using a cellular automaton system with only 8 states (as compared with von Neumann's 29). For many years, enthusiastic graduate students at the Michigan group continued to do important research on the relationships between information, logic, complexity and biology.

Meanwhile, in 1968, the mathematician John Horton Conway, working in England at Cambridge University, invented a simple game which greatly increased the popularity of the cellular automaton concept. Conway's game, which he called "Life", was played on an infinite checker-board-like lattice of cells, each cell having only two states, "alive" or "dead". The rules which Conway proposed are as follows: "If a cell on the checkerboard is alive, it will survive in the next time step (generation) if there are either two or three neighbors also alive. It will die of overcrowding if there are more than three live neighbors, and it will die of exposure if there are fewer than two. If a cell on the checkerboard is dead, it will remain dead in the next generation unless exactly three of its eight neighbors is alive. In that case, the cell will be 'born' in the next generation".

Originally Conway's Life game was played by himself and by his colleagues at Cambridge University's mathematics department in their common room: At first the game was played on table tops at tea time. Later it spilled over from the tables to the floor, and tea time began to extend: far into the afternoons. Finally, wishing to convert a wider audience to his game, Conway submitted it to Martin Gardner, who wrote a popular column on "Mathematical Games" for the *Scientific American*. In this way Life spread to MIT's Artificial Intelligence Laboratory, where it created such interest that the MIT group designed a small computer specifically dedicated to rapidly implementing Life's rules.

The reason for the excitement about Conway's Life game was that it seemed capable of generating extremely complex patterns, starting from relatively simple configurations

¹² Semiotics is defined as the study of signs (see Appendix 2).

and using only its simple rules. Ed Fredkin, the director of MIT's Artificial Intelligence Laboratory, became enthusiastic about cellular automata because they seemed to offer a model for the way in which complex phenomena can emerge from the laws of nature, which are after all very simple. In 1982, Fredkin (who was independently wealthy because of a successful computer company which he had founded) organized a conference on cellular automata on his private island in the Caribbean. The conference is notable because one of the participants was a young mathematical genius named Stephen Wolfram, who was destined to refine the concept of cellular automata and to become one of the leading theoreticians in the field¹³.

One of Wolfram's important contributions was to explore exhaustively the possibilities of 1-dimensional cellular automata. No one before him had looked at 1-dimensional CA's, but in fact they had two great advantages: The first of these advantages was simplicity, which allowed Wolfram to explore and classify the possible rule sets. Wolfram classified the rule sets into 4 categories, according to the degree of complexity which they generated. The second advantage was that the configurations of the system in successive generations could be placed under one another to form an easily-surveyed 2-dimensional visual display. Some of the patterns generated in this way were strongly similar to the patterns of pigmentation on the shells of certain molluscs. The strong resemblance seemed to suggest that Wolfram's 1-dimensional cellular automata might yield insights into the mechanism by which the pigment patterns are generated.

In general, cellular automata seemed to be promising models for gaining insight into the fascinating and highly important biological problem of morphogenesis: How does the fertilized egg translate the information on the genome into the morphology of the growing embryo, ending finally with the enormously complex morphology of a fully developed and fully differentiated multicellular animal? Our understanding of this amazing process is as yet very limited, but there is evidence that as the embryo of a multicellular animal develops, cells change their state in response to the states of neighboring cells. In the growing embryo, the "state" of a cell means the way in which it is differentiated, i.e., which genes are turned on and which off - which information on the genome is available for reading, and which segments are blocked. Neighboring cells signal to each other by means of chemical messengers¹⁴. Clearly there is a close analogy between the way complex patterns develop in a cellular automaton, as neighboring cells influence each other and change their states according to relatively simple rules, and the way in which the complex morphology of a multicellular animal develops in the growing embryo.

Conway's Life game attracted another very important worker to the field of cellular automata: In 1971, Christopher Langton was working as a computer programmer in the Stanley Cobb Laboratory for Psychiatric Research at Massachusetts General Hospital. When colleagues from MIT brought to the laboratory a program for executing Life, Langton was immediately interested. He recalls "It was the first hint that there was a distinction

¹³ As many readers probably know, Stephen Wolfram was also destined to become a millionaire by inventing the elegant symbol-manipulating program system, Mathematica.

¹⁴ We can recall the case of slime mold cells which signal to each other by means of the chemical messenger, cyclic AMP.

between the hardware and the behavior which it would support... You had the feeling that there was something very deep here in this little artificial universe and its evolution through time. [At the lab] we had a lot of discussions about whether the program could be open ended - could you have a universe in which life could evolve?"

Later, at the University of Arizona, Langton read a book describing von Neumann's theoretical work on automata. He contacted Arthur Burks, von Neumann's editor, who told him that no self-replicating automaton had actually been implemented, although E.F. Codd had proposed a simplified plan with only 8 states instead of 29. Burks suggested to Langton that he should start by reading Codd's book.

When Langton studied Codd's work, he realized that part of the problem was that both von Neumann and Codd had demanded that the self-reproducing automaton should be able to function as a universal Turing machine, i.e., as a universal computer. When Langton dropped this demand (which he considered to be more related to mathematics than to biology) he was able to construct a relatively simple self-reproducing configuration in an 8-state 2-dimensional lattice of CA cells. As they reproduced themselves, Langton's loop-like cellular automata filled the lattice of cells in a manner reminiscent of a growing coral reef, with actively reproducing loops on the surface of the filled area, and "dead" (nonreproducing) loops in the center.

Langton continued to work with cellular automata as a graduate student at Arthur Burks' Logic of Computers Group at Michigan. His second important contribution to the field was an extension of Wolfram's classification of rule sets for cellular automata. Langton introduced a parameter λ to characterize various sets of rules according to the type of behavior which they generated. Rule sets with a value near to the optimum ($\lambda = 0.273$) generated complexity similar to that found in biological systems. This value of Langton's λ parameter corresponded to a borderline region between periodicity and chaos.

After obtaining a Ph.D. from Burks' Michigan group, Christopher Langton moved to the Center for Nonlinear Studies at Los Alamos, New Mexico, where in 1987 he organized an "Interdisciplinary Workshop on the Synthesis and Simulation of Living Systems" - the first conference on artificial life ever held. Among the participants were Richard Dawkins, Astrid Lindenmayer, John Holland, and Richard Laing. The noted Oxford biologist and author Richard Dawkins was interested in the field because he had written a computer program for simulating and teaching evolution. Astrid Lindenmayer and her coworkers in Holland had written programs capable of simulating the morphogenesis of plants in an astonishingly realistic way. As was mentioned above, John Holland pioneered the development of genetic algorithms, while Richard Laing was the leader of Nasals study to determine whether self-reproducing factories might be feasible.

Langton's announcement for the conference, which appeared in the Scientific American, stated that "Artificial life is the study of artificial systems that exhibit behavior characteristic of natural living systems...The ultimate goal is to extract the logical form of living systems. Microelectronic technology and genetic engineering will soon give us the capability to create new life *in silico* as well as *in vitro*. This capacity will present humanity with the most far-reaching technical, theoretical, and ethical challenges it has ever confronted. The time seems appropriate for a gathering of those involved in attempts to simulate or

synthesize aspects of living systems.”

In the 1987 workshop on artificial life, a set of ideas which had gradually emerged during the previous decades of work on automata and simulations of living systems became formalized and crystallized: All of the participants agreed that something more than reductionism was needed to understand the phenomenon of life. This belief was not a revival of vitalism; it was instead a conviction that the abstractions of molecular biology are not in themselves sufficient. The type of abstraction found in Darwin’s theory of natural selection was felt to be nearer to what was needed. The viewpoints of thermodynamics and statistical mechanics were also helpful. What was needed, it was felt, were insights into the flow of information in complex systems; and computer simulations could give us this insight. The fact that the simulations might take place in *silico* did not detract from their validity. The logic and laws governing complex systems and living systems were felt to be independent of the medium.

As Langton put it, “The ultimate goal of artificial life would be to create ‘life’ in some other medium, ideally a virtual medium where the essence of life has been abstracted from the details of its implementation in any particular model. We would like to build models that are so lifelike that they cease to become models of life and become examples of life themselves.”

Most of the participants at the first conference on artificial life had until then been working independently, not aware that many other researchers shared their viewpoint. Their conviction that the logic of a system is largely independent of the medium echoes the viewpoint of the Macy Conferences on cybernetics in the 1940’s, where the logic of feedback loops and control systems was studied in a wide variety of contexts, ranging from biology and anthropology to computer systems. A similar viewpoint can also be found in biosemiotics (Appendix 2), where, in the words of the Danish biologist Jesper Hoffmeyer, “the sign, rather than the molecule” is considered to be the starting point for studying life. In other words, the essential ingredient of life is information; and information can be expressed in many ways. The medium is less important than the message.

The conferences on artificial life have been repeated each year since 1987, and European conferences devoted to the new and rapidly growing field have also been organized. Langton himself moved to the Santa Fe Institute, where he became director of the institute’s artificial life program and editor of a new journal, *Artificial Life*. The first three issues of the journal have been published as a book by the MIT Press, and the book presents an excellent introduction to the field.

Among the scientists who were attracted to the artificial life conferences was the biologist Thomas Ray, a graduate of Florida State University and Harvard, and an expert in the ecology of tropical rain forests. In the late 1970’s, while he was working on his Harvard Ph.D., Ray happened to have a conversation with a computer expert from the MIT Artificial Intelligence Lab, who mentioned to him that computer programs can replicate. To Ray’s question “How?”, the AI man answered “Oh, it’s trivial.”

Ray continued to study tropical ecologies, but the chance conversation from his Cambridge days stuck in his mind. By 1989 he had acquired an academic post at the University of Delaware, and by that time he had also become proficient in computer programming.

He had followed with interest the history of computer viruses. Were these malicious creations in some sense alive? Could it be possible to make self-replicating computer programs which underwent evolution by natural selection? Ray considered John Holland's genetic algorithms to be analogous to the type of selection imposed by plant and animal breeders in agriculture. He wanted to see what would happen to populations of digital organisms that found their own criteria for natural selection - not humanly imposed goals, but self-generated and open-ended criteria growing naturally out of the requirements for survival.

Although he had a grant to study tropical ecologies, Ray neglected the project and used most of his time at the computer, hoping to generate populations of computer organisms that would evolve in an open-ended and uncontrolled way. Luckily, before starting his work in earnest, Thomas Ray consulted Christopher Langton and his colleague James Farmer at the Center for Nonlinear Studies in New Mexico. Langton and Farmer realized that Ray's project could be a very dangerous one, capable of producing computer viruses or worms far more malignant and difficult to eradicate than any the world had yet seen. They advised Ray to make use of Turing's concept of a virtual computer. Digital organisms created in such a virtual computer would be unable to live outside it. Ray adopted this plan, and began to program a virtual world in which his freely evolving digital organisms could live. He later named the system "Tierra".

Ray's Tierra was not the first computer system to aim at open-ended evolution. Steen Rasmussen, working at the Danish Technical University, had previously produced a system called "VENUS" (Virtual Evolution in a Nonstochastic Universe Simulator) which simulated the very early stages of the evolution of life on earth. However, Ray's aim was not to understand the origin of life, but instead to produce digitally something analogous to the evolutionary explosion of diversity that occurred on earth at the start of the Cambrian era. He programmed an 80-byte self-reproducing digital organism which he called "Ancestor", and placed it in Tierra, his virtual Garden of Eden.

Ray had programmed a mechanism for mutation into his system, but he doubted that he would be able to achieve an evolving population with his first attempt. As it turned out, Ray never had to program another organism. His 80-byte Ancestor reproduced and populated his virtual earth, changing under the action of mutation and natural selection in a way that astonished and delighted him.

In his freely evolving virtual zoo, Ray found parasites, and even hyperparasites, but he also found instances of altruism and symbiosis. Most astonishingly of all, when he turned off the mutations in his Eden, his organisms invented sex (using mechanisms which Ray had introduced to allow for parasitism). They had never been told about sex by their creator, but they seemed to find their own way to the Tree of Knowledge.

Thomas Ray expresses the aims of his artificial life research as follows:¹⁵ "Everything we know about life is based on one example: Life on Earth. Everything we know about intelligence is based on one example: Human intelligence. This limited experience burdens us with preconceptions, and limits our imaginations... How can we go beyond our conceptual limits, find the natural form of intelligent processes in the digital medium, and work

¹⁵ T. Ray, <http://www.hip.atr.co.jp/ray/pubs/pubs.html>

with the medium to bring it to its full potential, rather than just imposing the world we know upon it by forcing it to run a simulation of our physics, chemistry and biology?..."

"In the carbon medium it was evolution that explored the possibilities inherent in the medium, and created the human mind. Evolution listens to the medium it is embedded in. It has the advantage of being mindless, and therefore devoid of preconceptions, and not limited by imagination." "I propose the creation of a digital nature - a system of wildlife reserves in cyberspace in the interstices between human colonizations, feeding off unused CPU-cycles and permitted a share of our bandwidth. This would be a place where evolution can spontaneously generate complex information processes, free from the demands of human engineers and market analysts telling it what the target applications are - a place for a digital Cambrian explosion of diversity and complexity..."

"It is possible that out of this digital nature, there might emerge a digital intelligence, truly rooted in the nature of the medium, rather than brutishly copied from organic nature. It would be a fundamentally alien intelligence, but one that would complement rather than duplicate our talents and abilities."

Have Thomas Ray and other "a-lifers"¹⁶ created artificial living organisms? Or have they only produced simulations that mimic certain aspects of life? Obviously the answer to this question depends on the definition of life, and there is no commonly agreed-upon definition. Does life have to involve carbon chemistry? The a-lifers call such an assertion "carbon chauvinism". They point out that elsewhere in the universe there may exist forms of life based on other media, and their program is to find medium-independent characteristics which all forms of life must have.

A living organism is a complex system produced by an input of thermodynamic information in the form of Gibbs free energy. This incoming information keeps the system very far away from thermodynamic equilibrium, and allows it to achieve a statistically unlikely and complex configuration. The information content of any complex (living) system is a measure of how unlikely it would be to arise by chance. With the passage of time, the entropy of the universe increases, and the almost unimaginably improbable initial configuration of the universe is converted into complex free-energy-using systems that could never have arisen by pure chance. Life maintains itself and evolves by feeding on Gibbs free energy, that is to say, by feeding on the enormous improbability of the initial conditions of the universe.

All of the forms of artificial life that we have discussed derive their complexity from the consumption of free energy. For example, Spiegelman's evolving RNA molecules feed on the Gibbs free energy of the phosphate bonds of their precursors, ATP, GTP, UTP, and CTP. This free energy is the driving force behind artificial evolution which Spiegelman observed. In his experiment, thermodynamic information in the form of high-energy phosphate bonds is converted into cybernetic information.

Similarly, in the polymerase chain reaction, the Gibbs free energy of the phosphate bonds in the precursor molecules ATP, TTP, GTP and CTP drives the reaction. With the aid of the enzyme DNA polymerase, the soup of precursors is converted into a highly

¹⁶ In this terminology, ordinary biologists are "b-lifers".

improbable configuration consisting of identical copies of the original sequence. Despite the high improbability of the resulting configuration, the entropy of the universe has increased in the copying process. The improbability of the set of copies is less than the improbability of the high energy phosphate bonds of the precursors.

The polymerase chain reaction reflects on a small scale, what happens on a much larger scale in all living organisms. Their complexity is such that they never could have originated by chance, but although their improbability is extremely great, it is less than the still greater improbability of the configurations of matter and energy from which they arose. As complex systems are produced, the entropy of the universe continually increases, i.e., the universe moves from a less probable configuration to a more probable one.

In Thomas Ray's experiments, the source of thermodynamic information is the electrical power needed to run the computer. In an important sense one might say that the digital organisms in Ray's Tierra system are living. This type of experimentation is in its infancy, but since it combines the great power of computers with the even greater power of natural selection, it is hard to see where it might end.

Suggestions for further reading

1. H. Babbage, *Babbages Calculating Engines: A Collection of Papers by Henry Prevost Babbage*, MIT Press, (1984).
2. A.M. Turing, *The Enigma of Intelligence*, Burnett, London (1983).
3. Ft. Penrose, *The Emperor's New Mind: Concerning Computers, Minds, and the Laws of Physics*, Oxford University Press, (1989).
4. S. Wolfram, *A New Kind of Science*, Wolfram Media, Champaign IL, (2002).
5. A.M. Turing, *On computable numbers, with an application to the Entscheidungsproblem*, Proc. Lond. Math. Soc. Ser 2, **42**, (1937). Reprinted in M. David Ed., *The Undecidable*, Raven Press, Hewlett N.Y., (1965).
6. N. Metropolis, J. Howlett, and Gian-Carlo Rota (editors), *A History of Computing in the Twentieth Century*, Academic Press (1980).
7. J. Shurkin, *Engines of the Mind: A History of Computers*, W.W. Norton, (1984).
8. J. Palfreman and D. Swade, *The Dream Machine: Exploring the Computer Age*, BBC Press (UK), (1991).
9. T.J. Watson, Jr. and P. Petre, *Father, Son, and Co.*, Bantam Books, New York, (1991).
10. A. Hodges, Alan Turing: *The Enigma*, Simon and Schuster, (1983).
11. H.H. Goldstein, *The Computer from Pascal to Von Neumann*, Princeton University Press, (1972).
12. C.J. Bashe, L.R. Johnson, J.H. Palmer, and E.W. Pugh, *IBM's Early Computers*, Vol. 3 in the History of Computing Series, MIT Press, (1986).
13. K.D. Fishman, *The Computer Establishment*, McGraw-Hill, (1982).
14. S. Levy, *Hackers*, Doubleday, (1984).
15. S. Franklin, *Artificial Minds*, MIT Press, (1997).

16. P. Freiberger and M. Swaine, *Fire in the Valley: The Making of the Personal Computer*, Osborne/McGraw-Hill, (1984).
17. R.X. Cringely, *Accidental Empires*, Addison-Wesley, (1992).
18. R. Randell editor, *The Origins of Digital Computers, Selected Papers*, Springer-Verlag, New York (1973).
19. H. Lukoff, *From Dits to Bits*, Robotics Press, (1979).
20. D.E. Lundstrom, *A Few Good Men from Univac*, MIT Press, (1987).
21. D. Rutland, *Why Computers Are Computers (The SWAC and the PC)*, Wren Publishers, (1995).
22. P.E. Ceruzzi, *Reckoners: The Prehistory of the Digital Computer, from Relays to the Stored Program Concept, 1935-1945*, Greenwood Press, Westport, (1983)
23. S.G. Nash, *A History of Scientific Computing*, Adison-Wesley, Reading Mass., (1990).
24. P.E. Ceruzzi, *Crossing the divide: Architectural issues and the emergence of stored programme computers, 1935-1953*, IEEE Annals of the History of Computing, **19**, 5-12, January-March (1997).
25. P.E. Ceruzzi, *A History of Modern Computing*, MIT Press, Cambridge MA, (1998).
26. K. Zuse, *Some remarks on the history of computing in Germany*, in *A History of Computing in the 20th Century*, N. Metropolis et al. editors, 611-627, Academic Press, New York, (1980).
27. A.R. Mackintosh, *The First Electronic Computer*, Physics Today, March, (1987).
28. S.H. Hollingdale and G.C. Tootil, *Electronic Computers*, Penguin Books Ltd. (1970).
29. A. Hodges, *Alan Turing: The Enigma*, Simon and Schuster, New York, (1983).
30. A. Turing, *On computable numbers with reference to the Entscheidungsproblem*, Journal of the London Mathematical Society, **II, 2. 42**, 230-265 (1937).
31. J. von Neumann, *The Computer and the Brain*, Yale University Press, (1958).
32. I.E. Sutherland, *Microelectronics and computer science*, Scientific American, 210-228, September (1977).
33. W. Aspray, *John von Neumann and the Origins of Modern Computing*, M.I.T. Press, Cambridge MA, (1990, 2nd ed. 1992).
34. W. Aspray, *The history of computing within the history of information technology*, History and Technology, **11**, 7-19 (1994).
35. G.F. Luger, *Computation and Intelligence: Collected Readings*, MIT Press, (1995).
36. Z.W. Pylyshyn, *Computation and Cognition: Towards a Foundation for Cognitive Science*, MIT Press, (1986).
37. D.E. Shasha and C. Lazere, *Out of Their Minds: The Creators of Computer Science*, Copernicus, New York, (1995).
38. W. Aspray, *An annotated bibliography of secondary sources on the history of software*, Annals of the History of Computing **9**, 291-243 (1988).
39. R. Kurzweil, *The Age of Intelligent Machines*, MIT Press, (1992).
40. S.L. Garfinkel and H. Abelson, eds., *Architects of the Information Society: Thirty-Five Years of the Laboratory for Computer Sciences at MIT*, MIT Press, (1999).
41. J. Haugeland, *Artificial Intelligence: The Very Idea*, MIT Press, (1989).

42. M.A. Boden, *Artificial Intelligence in Psychology: Interdisciplinary Essays*, MIT Press, (1989).
43. J.W. Cortada, *A Bibliographic Guide to the History of Computer Applications, 1950-1990*, Greenwood Press, Westport Conn., (1996).
44. M. Campbell-Kelly and W. Aspry, *Computer: A History of the Information Machine*, Basic Books, New York, (1996).
45. B.I. Blum and K. Duncan, editors, *A History of Medical Informatics*, ACM Press, New York, (1990).
46. J.-C. Guedon, La Planete Cyber, *Internet et Cyberspace*, Gallimard, (1996).
47. S. Augarten, *Bit by Bit: An Illustrated History of Computers*, Unwin, London, (1985).
48. N. Wiener, *Cybernetics; or Control and Communication in the Animal and the Machine*, The Technology Press, John Wiley and Sons, New York, (1948).
49. W.R. Ashby, *An Introduction to Cybernetics*, Chapman and Hall, London, (1956).
50. M.A. Arbib, *A partial survey of cybernetics in eastern Europe and the Soviet Union*, Behavioral Sci., **11**, 193-216, (1966).
51. A. Rosenblueth, N. Wiener and J. Bigelow, *Behavior, purpose and teleology*, Phil. Soc. **10 (1)**, 18-24 (1943).
52. N. Wiener and A. Rosenblueth, *Conduction of impulses in cardiac muscle*, Arch. Inst. Cardiol. Mex., **16**, 205-265 (1946).
53. H. von Foerster, editor, *Cybernetics - circular, causal and feed-back mechanisms in biological and social systems. Transactions of sixth-tenth conferences*, Josiah J. Macy Jr. Foundation, New York, (1950- 1954).
54. W.S. McCulloch and W. Pitts, *A logical calculus of ideas immanent in nervous activity*, Bull. Math. Biophys., **5**, 115-133 (1943).
55. W.S. McCulloch, *An Account of the First Three Conferences on Teleological Mechanisms*, Josiah Macy Jr. Foundation, (1947).
56. G.A. Miller, *Languages and Communication*, McGraw-Hill, New York, (1951).
57. G.A. Miller, *Statistical behavioristics and sequences of responses*, Psychol. Rev. **56**, 6 (1949).
58. G. Bateson, *Bali - the value system of a steady state*, in M. Fortes, editor, *Social Structure Studies Presented to A.R. Radcliffe-Brown*, Clarendon Press, Oxford, (1949).
59. G. Bateson, *Communication, the Social Matrix of Psychiatry*, Norton, (1951).
60. G. Bateson, *Steps to an Ecology of Mind*, Chandler, San Francisco, (1972).
61. G. Bateson, *Communication et Societe*, Seuil, Paris, (1988).
62. S. Heims, *Gregory Bateson and the mathematicians: From interdisciplinary interactions to societal functions*, J. History Behavioral Sci., **13**, 141-159 (1977).
63. S. Heims, *John von Neumann and Norbert Wiener. From Mathematics to the Technology of Life and Death*, MIT Press, Cambridge MA, (1980).
64. S. Heims, *The Cybernetics Group*, MIT Press, Cambridge MA, (1991).
65. G. van de Vijver, *New Perspectives on Cybernetics (Self-Organization, Autonomy and Connectionism)*, Kluwer, Dordrecht, (1992).
66. A. Bavelas, *A mathematical model for group structures*, Appl. Anthropol. **7 (3)**, 16 (1948).

67. P. de Latil, *La Pensee Artificielle - Introduction a la Cybernetique*, Gallimard, Paris, (1953).
68. L.K. Frank, G.E. Hutchinson, W.K. Livingston, W.S. McCulloch and N. Wiener, *Teleological Mechanisms*, Ann. N.Y. Acad. Sci. **50**, 187- 277 (1948).
69. H. von Foerster, *Quantum theory of memory*, in H. von Foerster, editor, *Cybernetics - circular, causal and feed-back mechanisms in biological and social systems*. Transactions of the sixth conferences, Josiah J. Macy Jr. Foundation, New York, (1950).
70. H. von Foerster, *Observing Systems*, Intersystems Publications, California, (1984).
71. H. von Foerster, *Understanding Understanding: Essays on Cybernetics and Cognition*, Springer, New York, (2002).
72. M. Newborn, *Kasparov vs. Deep Blue: Computer Chess Comes of age*, Springer Verlag, (1996).
73. K.M. Colby, *Artificial Paranoia: A Computer Simulation of the Paranoid Process*, Pergamon Press, New York, (1975).
74. J.Z. Young, *Discrimination and learning in the octopus*, in H. von Foerster, editor, *Cybernetics - circular, causal and feed-back mechanisms in biological and social systems*. Transactions of the ninth conference, Josiah J. Macy Jr. Foundation, New York, (1953).
75. M.J. Apter and L. Wolpert, *Cybernetics and development*. I. Information theory, J. Theor. Biol. **8**, 244-257 (1965).
76. H. Atlan, *L'Organisation Biologique et la Theorie de l'Information*, Hermann, Paris, (1972).
77. H. Atlan, *On a formal definition of organization*, J. Theor. Biol. **45**, 295-304 (1974).
78. H. Atlan, *Organization du vivant, information et auto-organization*, in Volume Symposium 1986 de l'Encyclopediea Universalis, pp. 355-361, Paris, (1986).
79. E.R. Kandel, Nerve cells and behavior, Scientific American, **223**, 57-70, July, (1970).
80. E.R. Kandel, *Small systems of neurons*, Scientific American, **241 no.3**, 66-76 (1979).
81. A.K. Katchalsky et al., *Dynamic patterns of brain cell assemblies*, Neurosciences Res. Prog. Bull., **12 no.1**, (1974).
82. G.E. Moore, *Cramming more components onto integrated circuits*, Electronics, April 19, (1965).
83. P. Gelsinger, P. Gargini, G. Parker and A. Yu, *Microprocessors circa 2000*, IEEE Spectrum, October, (1989).
84. P. Baron, *On distributed communications networks*, IEEE Trans. Comm. Systems, March (1964).
85. V.G. Cerf and R.E. Khan, *A protocol for packet network intercommunication*, Trans. Comm. Tech. **COM-22, V5**, 627-641, May (1974).
86. L. Kleinrock, *Communication Nets: Stochastic Message Flow and Delay*, McGraw-Hill, New York, (1964).
87. L. Kleinrock, *Queueing Systems: Vol. II, Computer Applications*, Wiley, New York, (1976).
88. R. Kahn, editor, *Special Issue on Packet Communication Networks*, Proc. IEEE, **66**, November, (1978).

89. L.G. Roberts, *The evolution of packet switching*, Proc. of the IEEE **66**, 1307-13, (1978).
90. J. Abbate, *The electrical century: Inventing the web*, Proc. IEEE **87**, November, (1999).
91. J. Abbate, *Inventing the Internet*, MIT Press, Cambridge MA, (1999).
92. J.C. McDonald, editor, *Fundamentals of Digital Switching, 2nd Edition*, Plenum, New York, (1990).
93. B. Metcalfe, *Packet Communication, Peer-to-Peer Communication*, San Jose Calif, (1996).
94. T. Berners-Lee, *The Original Design and Ultimate Destiny of the World Wide Web by its Inventor*, Harper San Francisco, (1999).
95. J. Clark, *Netscape Time: The Making of the Billion-Dollar Start-Up That Took On Microsoft*, St. Martin's Press, New York, (1999).
96. J. Wallace, *Overdrive: Bill Gates and the Race to Control Cyberspace*, Wiley, New York, (1997).
97. P. Cunningham and F. Froschl, *The Electronic Business Revolution*, Springer Verlag, New York, (1999).
98. J.L. McKenny, *Waves of Change: Business Evolution Through Information Technology*, Harvard Business School Press, (1995).
99. M.A. Cosumano, *Competing on Internet Time: Lessons From Netscape and Its Battle with Microsoft*, Free Press, New York, (1998).
100. F.J. Dyson, *The Sun, the Genome and the Internet: Tools of Scientific Revolutions*, Oxford University Press, (1999).
101. L. Bruno, *Fiber Optimism: Nortel, Lucent and Cisco are battling to win the high-stakes fiber-optics game*, Red Herring, June (2000).
102. N. Cochrane, *We're insatiable: Now it's 20 million million bytes a day*, Melbourne Age, January 15, (2001).
103. K.G. Coffman and A.N. Odlyzko, *The size and growth rate of the Internet*, First Monday, October, (1998).
104. C.A. Eldering, M.L. Sylla, and J.A. Eisenach, *Is there a Moore's law for bandwidth?*, IEEE Comm. Mag., 2-7, October, (1999).
105. G. Gilder, *Fiber keeps its promise: Get ready, bandwidth will triple each year for the next 25 years*, Forbes, April 7, (1997).
106. A.M. Noll, *Does data traffic exceed voice traffic?*, Comm. ACM, 121- 124, June, (1999).
107. B. St. Arnaud, J. Coulter, J. Fitchett, and S. Mokbel, *Architectural and engineering issues for building an optical Internet*, Proc. Soc. Optical Eng. (1998).
108. M. Weisner, *The computer for the 21st century*, Scientific American, September, (1991).
109. R. Wright, *Three Scientists and Their Gods*, Time Books, (1988).
110. S. Nora and A. Mine, *The Computerization of Society*, MIT Press, (1981).
111. T. Forester, *Computers in the Human Context: Information Theory, Productivity, and People*, MIT Press, (1989).

112. J. Hoffmeyer, *Some semiotic aspects of the psycho-physical relation: the endo-exosemiotic boundary*, in Biosemiotics. The Semiotic Web, T.A. Sebeok and J. Umiker-Sebeok, editors, Mouton de Gruyter, Berlin/New York, (1991).
113. J. Hoffmeyer, *The swarming cyberspace of the body*, Cybernetics and Human Knowing, **3(1)**, 1-10 (1995).
114. J. Hoffmeyer, *Signs of Meaning in the Universe*, Indiana University Press, Bloomington IN, (1996).
115. J. Hoffmeyer, *Biosemiotics: Towards a new synthesis in biology*, European J. Semiotic Stud. **9(2)**, 355-376 (1997).
116. J. Hoffmeyer and C. Emmeche, *Code-duality and the semiotics of nature*, in On Semiotic Modeling, M. Anderson and F. Merrell, editors, Mouton de Gruyter, New York, (1991).
117. C. Emmeche and J. Hoffmeyer, *From language to nature - The semiotic metaphor in biology*, Semiotica, **84**, 1-42 (1991).
118. C. Emmeche, *The biosemiotics of emergent properties in a pluralist ontology*, in Semiosis, Evolution, Energy: Towards a Reconceptualization of the Sign, E. Taborsky, editor, Shaker Verlag, Aachen, (1999).
119. S. Brier, *Information and consciousness: A critique of the mechanistic concept of information*, in Cybernetics and Human Knowing, **1(2/3)**, 71-94 (1992).
120. S. Brier, *Ciber-Semiotics: Second-order cybernetics and the semiotics of C.S. Peirce*, Proceedings from the Second European Congress on System Science, Prague, October 5-8, 1993, AFCET, (1993).
121. S. Brier, *A cybernetic and semiotic view on a Galilean theory of psychology*, Cybernetics and Human Knowing, **2 (2)**, 31-46 (1993).
122. S. Brier, *Cybersemiotics: A suggestion for a transdisciplinary frame- work for description of observing, anticipatory, and meaning producing systems*, in D.M. Dubois, editor, Computing Anticipatory Systems, CASYS - First International Conference, Liege, Belgium 1997, AIP Conference Proceedings no. 437, (1997).
123. S. Oyama, *The Ontogeny of Information*, Cambridge University Press, (1985).
124. J. Hoffmeyer, *The swarming cyberspace of the body*, Cybernetics and Human Knowing, **3(1)**, 1-10 (1995).
125. J.L. Casti and A. Karlqvist, editors, *Complexity, Language, and Life: Mathematical Approaches*, Springer, Berlin, (1985).
126. H. Maturana and F. Varela, *Autopoiesis and Cognition: The Realization of the Living*, Reidel, London, (1980).
127. J. Mingers, *Self-Producing Systems: Implications and Application of Autopoiesis*, Plenum Press, New York, (1995).
128. J. Buchler, editor, *Philosophical Writings of Peirce: Selected and Edited with an Introduction by Justus Buchler*, Dover Publications, New York, (1955).
129. T.L. Short, *Peirce's semiotic theory of the self*, Semiotica, **91 (1/2)**, 109-131 (1992).
130. J. von Uexküll, *Umwelt und Innenwelt der Tiere. 2. verm. und verb. Aufl.*, Springer, Berlin, (1921).
131. J. von Uexküll, *The theory of meaning*, Semiotica, **42(1)**, 25-87 (1982 [1940]).

132. T. von Uexküll, *Introduction: Meaning and science in Jacob von Uexküll's concept of biology*, *Semiotica*, **42**, 1-24 (1982).
133. T. von Uexküll, *Medicine and semiotics*, *Semiotica*, **61**, 201-217 (1986).
134. G. Bateson, *Form, substance, and difference. Nineteenth Annual Korzybski Memorial Lecture*, (1970). Reprinted in G. Bateson, *Steps to an Ecology of Mind*, Balentine Books, New York, (1972), pp. 448-464.
135. G. Bateson, *Mind and Nature: A Necessary Unity*, Bantam Books, New York, (1980).
136. G. Bateson, *Sacred Unity: Further Steps to an Ecology of Mind*, Harper Collins, New York, (1991).
137. J. Ruesch and G. Bateson, *Communication*, Norton, New York, (1987).
138. E.F. Yates, *Semiotics as a bridge between information (biology) and dynamics (physics)*, *Recherches Semiotiques/Semiotic Inquiry* **5**, 347- 360 (1985).
139. T.A. Sebeok, *Communication in animals and men*, *Language*, **39**, 448-466 (1963).
140. T.A. Sebeok, *The Sign and its Masters*, University of Texas Press, (1979).
141. P. Bouissac, *Ecology of semiotic space: Competition, exploitation, and the evolution of arbitrary signs*, *Am. J. Semiotics*, **10**, 145-166 (1972).
142. F. Varla, *Autopoiesis: A Theory of Living Organization*, North Holland, New York, (1986).
143. R. Posner, K. Robins and T.A. Sebeok, editors, *Semiotics: A Handbook of the Sign-Theoretic Foundations of Nature and Culture*, Walter de Gruyter, Berlin, (1992).
144. R. Paton, *The ecologies of hereditary information*, *Cybernetics and Human Knowing*, **5(4)**, 31-44 (1998).
145. T. Stonier, *Information and the Internal Structure of the Universe*, Springer, Berlin, (1990).
146. T. Stonier, *Information and Meaning: An Evolutionary Perspective*, Springer, Berlin, (1997).
147. N. Metropolis, J. Howlett, and Gian-Carlo Rota (editors), *A History of Computing in the Twentieth Century*, Academic Press (1980).
148. S.H. Hollingdale and G.C. Tootil, *Electronic Computers*, Penguin Books Ltd. (1970).
149. Alan Turing, *The Enigma of Intelligence*, Burnett, London (1983).
150. R. Randell (editor), *The Origins of Digital Computers, Selected Papers*, Springer-Verlag, New York (1973).
151. Allan R. Mackintosh, *The First Electronic Computer*, *Physics Today*, March, (1987).
152. N. Metropolis, J. Howlett, and Gian-Carlo Rota (editors), *A History of Computing in the Twentieth Century*, Academic Press (1980).
153. S.H. Hollingdale and G.C. Tootil, *Electronic Computers*, Penguin Books Ltd. (1970).
154. R. Randell (editor), *The Origins of Digital Computers, Selected Papers*, Springer-Verlag, New York (1973).
155. Allan R. Mackintosh, *The First Electronic Computer*, *Physics Today*, March, (1987).
156. H. Babbage, *Babbages Calculating Engines: A Collection of Papers by Henry Prevost Babbage*, MIT Press, (1984).
157. A.M. Turing, *The Enigma of Intelligence*, Burnett, London (1983).

158. Ft. Penrose, *The Emperor's New Mind: Concerning Computers, Minds, and the Laws of Physics*, Oxford University Press, (1989).
159. S. Wolfram, *A New Kind of Science*, Wolfram Media, Champaign IL, (2002).
160. A.M. Turing, *On computable numbers, with an application to the Entscheidungsproblem*, Proc. Lond. Math. Soc. Ser 2, **42**, (1937). Reprinted in M. David Ed., *The Undecidable*, Raven Press, Hewlett N.Y., (1965).
161. N. Metropolis, J. Howlett, and Gian-Carlo Rota (editors), *A History of Computing in the Twentieth Century*, Academic Press (1980).
162. J. Shurkin, *Engines of the Mind: A History of Computers*, W.W. Norton, (1984).
163. J. Palfreman and D. Swade, *The Dream Machine: Exploring the Computer Age*, BBC Press (UK), (1991).
164. T.J. Watson, Jr. and P. Petre, *Father, Son, and Co.*, Bantam Books, New York, (1991).
165. A. Hodges, *Alan Turing: The Enigma*, Simon and Schuster, (1983).
166. H.H. Goldstein, *The Computer from Pascal to Von Neumann*, Princeton University Press, (1972).
167. C.J. Bashe, L.R. Johnson, J.H. Palmer, and E.W. Pugh, *IBM's Early Computers*, Vol. 3 in the History of Computing Series, MIT Press, (1986).
168. K.D. Fishman, *The Computer Establishment*, McGraw-Hill, (1982).
169. S. Levy, *Hackers*, Doubleday, (1984).
170. S. Franklin, *Artificial Minds*, MIT Press, (1997).
171. P. Freiburger and M. Swaine, *Fire in the Valley: The Making of the Personal Computer*, Osborne/McGraw-Hill, (1984).
172. R.X. Cringely, *Accidental Empires*, Addison-Wesley, (1992).
173. R. Randell editor, *The Origins of Digital Computers, Selected Papers*, Springer-Verlag, New York (1973).
174. H. Lukoff, *From Dits to Bits*, Robotics Press, (1979).
175. D.E. Lundstrom, *A Few Good Men from Univac*, MIT Press, (1987).
176. D. Rutland, *Why Computers Are Computers (The SWAC and the PC)*, Wren Publishers, (1995).
177. P.E. Ceruzzi, *Reckoners: The Prehistory of the Digital Computer, from Relays to the Stored Program Concept, 1935-1945*, Greenwood Press, Westport, (1983)
178. S.G. Nash, *A History of Scientific Computing*, Addison-Wesley, Reading Mass., (1990).
179. P.E. Ceruzzi, *Crossing the divide: Architectural issues and the emergence of stored programme computers, 1935-1953*, IEEE Annals of the History of Computing, **19**, 5-12, January-March (1997).
180. P.E. Ceruzzi, *A History of Modern Computing*, MIT Press, Cambridge MA, (1998).
181. K. Zuse, *Some remarks on the history of computing in Germany*, in *A History of Computing in the 20th Century*, N. Metropolis et al. editors, 611-627, Academic Press, New York, (1980).
182. A.R. Mackintosh, *The First Electronic Computer*, Physics Today, March, (1987).
183. S.H. Hollingdale and G.C. Tootil, *Electronic Computers*, Penguin Books Ltd. (1970).
184. A. Hodges, *Alan Turing: The Enigma*, Simon and Schuster, New York, (1983).

185. A. Turing, *On computable numbers with reference to the Entscheidungsproblem*, Journal of the London Mathematical Society, **II**, **2**. **42**, 230-265 (1937).
186. J. von Neumann, *The Computer and the Brain*, Yale University Press, (1958).
187. I.E. Sutherland, *Microelectronics and computer science*, Scientific American, 210-228, September (1977).
188. W. Aspray, *John von Neumann and the Origins of Modern Computing*, M.I.T. Press, Cambridge MA, (1990, 2nd ed. 1992).
189. W. Aspray, *The history of computing within the history of information technology*, History and Technology, **11**, 7-19 (1994).
190. G.F. Luger, *Computation and Intelligence: Collected Readings*, MIT Press, (1995).
191. Z.W. Pylyshyn, *Computation and Cognition: Towards a Foundation for Cognitive Science*, MIT Press, (1986).
192. D.E. Shasha and C. Lazere, *Out of Their Minds: The Creators of Computer Science*, Copernicus, New York, (1995).
193. W. Aspray, *An annotated bibliography of secondary sources on the history of software*, Annals of the History of Computing **9**, 291-243 (1988).
194. R. Kurzweil, *The Age of Intelligent Machines*, MIT Press, (1992).
195. S.L. Garfinkel and H. Abelson, eds., *Architects of the Information Society: Thirty-Five Years of the Laboratory for Computer Sciences at MIT*, MIT Press, (1999).
196. J. Haugeland, *Artificial Intelligence: The Very Idea*, MIT Press, (1989).
197. M.A. Boden, *Artificial Intelligence in Psychology: Interdisciplinary Essays*, MIT Press, (1989).
198. J.W. Cortada, *A Bibliographic Guide to the History of Computer Applications, 1950-1990*, Greenwood Press, Westport Conn., (1996).
199. M. Campbell-Kelly and W. Aspry, *Computer: A History of the Information Machine*, Basic Books, New York, (1996).
200. B.I. Blum and K. Duncan, editors, *A History of Medical Informatics*, ACM Press, New York, (1990).
201. J.-C. Guedon, La Planete Cyber, *Internet et Cyberspace*, Gallimard, (1996).
202. S. Augarten, *Bit by Bit: An Illustrated History of Computers*, Unwin, London, (1985).
203. N. Wiener, *Cybernetics; or Control and Communication in the Animal and the Machine*, The Technology Press, John Wiley and Sons, New York, (1948).
204. W.R. Ashby, *An Introduction to Cybernetics*, Chapman and Hall, London, (1956).
205. M.A. Arbib, *A partial survey of cybernetics in eastern Europe and the Soviet Union*, Behavioral Sci., **11**, 193-216, (1966).
206. A. Rosenblueth, N. Weiner and J. Bigelow, *Behavior, purpose and teleology*, Phil. Soc. **10** (**1**), 18-24 (1943).
207. N. Weiner and A. Rosenblueth, *Conduction of impulses in cardiac muscle*, Arch. Inst. Cardiol. Mex., **16**, 205-265 (1946).
208. H. von Foerster, editor, *Cybernetics - circular, causal and feed-back mechanisms in biological and social systems. Transactions of sixth-tenth conferences*, Josiah J. Macy Jr. Foundation, New York, (1950- 1954).

209. W.S. McCulloch and W. Pitts, *A logical calculus of ideas immanent in nervous activity*, Bull. Math. Biophys., **5**, 115-133 (1943).
210. W.S. McCulloch, *An Account of the First Three Conferences on Teleological Mechanisms*, Josiah Macy Jr. Foundation, (1947).
211. G.A. Miller, *Languages and Communication*, McGraw-Hill, New York, (1951).
212. G.A. Miller, *Statistical behavioristics and sequences of responses*, Psychol. Rev. **56**, 6 (1949).
213. G. Bateson, *Bali - the value system of a steady state*, in M. Fortes, editor, *Social Structure Studies Presented to A.R. Radcliffe-Brown*, Clarendon Press, Oxford, (1949).
214. G. Bateson, *Communication, the Social Matrix of Psychiatry*, Norton, (1951).
215. G. Bateson, *Steps to an Ecology of Mind*, Chandler, San Francisco, (1972).
216. G. Bateson, *Communication et Societe*, Seuil, Paris, (1988).
217. S. Heims, *Gregory Bateson and the mathematicians: From interdisciplinary interactions to societal functions*, J. History Behavioral Sci., **13**, 141-159 (1977).
218. S. Heims, *John von Neumann and Norbert Wiener. From Mathematics to the Technology of Life and Death*, MIT Press, Cambridge MA, (1980).
219. S. Heims, *The Cybernetics Group*, MIT Press, Cambridge MA, (1991).
220. G. van de Vijver, *New Perspectives on Cybernetics (Self-Organization, Autonomy and Connectionism)*, Kluwer, Dordrecht, (1992).
221. A. Bavelas, *A mathematical model for group structures*, Appl. Anthropol. **7 (3)**, 16 (1948).
222. P. de Latil, *La Pensee Artificielle - Introduction a la Cybernetique*, Gallimard, Paris, (1953).
223. L.K. Frank, G.E. Hutchinson, W.K. Livingston, W.S. McCulloch and N. Wiener, *Teleological Mechanisms*, Ann. N.Y. Acad. Sci. **50**, 187- 277 (1948).
224. H. von Foerster, *Quantum theory of memory*, in H. von Foerster, editor, *Cybernetics - circular, causal and feed-back mechanisms in biological and social systems*. Transactions of the sixth conferences, Josiah J. Macy Jr. Foundation, New York, (1950).
225. H. von Foerster, *Observing Systems*, Intersystems Publications, California, (1984).
226. H. von Foerster, *Understanding Understanding: Essays on Cybernetics and Cognition*, Springer, New York, (2002).
227. M. Newborn, *Kasparov vs. Deep Blue: Computer Chess Comes of age*, Springer Verlag, (1996).
228. K.M. Colby, *Artificial Paranoia: A Computer Simulation of the Paranoid Process*, Pergamon Press, New York, (1975).
229. J.Z. Young, *Discrimination and learning in the octopus*, in H. von Foerster, editor, *Cybernetics - circular, causal and feed-back mechanisms in biological and social systems*. Transactions of the ninth conference, Josiah J. Macy Jr. Foundation, New York, (1953).
230. M.J. Apter and L. Wolpert, *Cybernetics and development*. I. Information theory, J. Theor. Biol. **8**, 244-257 (1965).
231. H. Atlan, *L'Organization Biologique et la Theorie de l'Information*, Hermann, Paris, (1972).

232. H. Atlan, *On a formal definition of organization*, J. Theor. Biol. 45, 295-304 (1974).
233. H. Atlan, *Organization du vivant, information et auto-organization*, in Volume Symposium 1986 de l'Encyclopediea Universalis, pp. 355-361, Paris, (1986).
234. E.R. Kandel, Nerve cells and behavior, Scientific American, **223**, 57-70, July, (1970).
235. E.R. Kandel, *Small systems of neurons*, Scientific American, **241 no.3**, 66-76 (1979).
236. A.K. Katchalsky et al., *Dynamic patterns of brain cell assemblies*, Neurosciences Res. Prog. Bull., **12 no.1**, (1974).
237. G.E. Moore, *Cramming more components onto integrated circuits*, Electronics, April 19, (1965).
238. P. Gelsinger, P. Gargini, G. Parker and A. Yu, *Microprocessors circa 2000*, IEEE Spectrum, October, (1989).
239. P. Baron, *On distributed communications networks*, IEEE Trans. Comm. Systems, March (1964).
240. V.G. Cerf and R.E. Khan, *A protocol for packet network intercommunication*, Trans. Comm. Tech. **COM-22, V5**, 627-641, May (1974).
241. L. Kleinrock, *Communication Nets: Stochastic Message Flow and Delay*, McGraw-Hill, New York, (1964).
242. L. Kleinrock, *Queueing Systems: Vol. II, Computer Applications*, Wiley, New York, (1976).
243. R. Kahn, editor, *Special Issue on Packet Communication Networks*, Proc. IEEE, **66**, November, (1978).
244. L.G. Roberts, *The evolution of packet switching*, Proc. of the IEEE **66**, 1307-13, (1978).
245. J. Abbate, *The electrical century: Inventing the web*, Proc. IEEE **87**, November, (1999).
246. J. Abbate, *Inventing the Internet*, MIT Press, Cambridge MA, (1999).
247. J.C. McDonald, editor, *Fundamentals of Digital Switching, 2nd Edition*, Plenum, New York, (1990).
248. B. Metcalfe, *Packet Communication, Peer-to-Peer Communication*, San Jose Calif, (1996).
249. T. Berners-Lee, *The Original Design and Ultimate Destiny of the World Wide Web by its Inventor*, Harper San Francisco, (1999).
250. J. Clark, *Netscape Time: The Making of the Billion-Dollar Start-Up That Took On Microsoft*, St. Martin's Press, New York, (1999).
251. J. Wallace, *Overdrive: Bill Gates and the Race to Control Cyberspace*, Wiley, New York, (1997).
252. P. Cunningham and F. Froschl, *The Electronic Business Revolution*, Springer Verlag, New York, (1999).
253. J.L. McKenny, *Waves of Change: Business Evolution Through Information Technology*, Harvard Business School Press, (1995).
254. M.A. Cosumano, *Competing on Internet Time: Lessons From Netscape and Its Battle with Microsoft*, Free Press, New York, (1998).

255. F.J. Dyson, *The Sun, the Genome and the Internet: Tools of Scientific Revolutions*, Oxford University Press, (1999).
256. L. Bruno, *Fiber Optimism: Nortel, Lucent and Cisco are battling to win the high-stakes fiber-optics game*, Red Herring, June (2000).
257. N. Cochrane, *We're insatiable: Now it's 20 million million bytes a day*, Melbourne Age, January 15, (2001).
258. K.G. Coffman and A.N. Odlyzko, The size and growth rate of the Internet, First Monday, October, (1998).
259. C.A. Eldering, M.L. Sylla, and J.A. Eisenach, *Is there a Moore's law for bandwidth?*, IEEE Comm. Mag., 2-7, October, (1999).
260. G. Gilder, *Fiber keeps its promise: Get ready, bandwidth will triple each year for the next 25 years*, Forbes, April 7, (1997).
261. A.M. Noll, *Does data traffic exceed voice traffic?*, Comm. ACM, 121- 124, June, (1999).
262. B. St. Arnaud, J. Coulter, J. Fitchett, and S. Mokbel, *Architectural and engineering issues for building an optical Internet*, Proc. Soc. Optical Eng. (1998).
263. M. Weisner, *The computer for the 21st century*, Scientific American, September, (1991).
264. R. Wright, *Three Scientists and Their Gods*, Time Books, (1988).
265. S. Nora and A. Mine, *The Computerization of Society*, MIT Press, (1981).
266. T. Forester, *Computers in the Human Context: Information Theory, Productivity, and People*, MIT Press, (1989).
267. P. Friedland and L.H. Kedes, *Discovering the secrets of DNA*, Comm. of the ACM, **28**, 1164-1185 (1985).
268. E.F. Meyer, *The first years of the protein data bank*, Protein Science **6**, 1591-7, July (1997).
269. C. Kulikowski, *Artificial intelligence in medicine: History, evolution and prospects*, in Handbook of Biomedical Engineering, J. Bronzine editor, 181.1-181.18, CRC and IEEE Press, Boca Raton Fla., (2000).
270. C. Gibas and P. Jambeck, *Developing Bioinformatics Computer Skills*, O'Reily, (2001).
271. F.L. Carter, *The molecular device computer: point of departure for large-scale cellular automata*, Physica D, **10**, 175-194 (1984).
272. K.E. Drexler, *Molecular engineering: an approach to the development of general capabilities for molecular manipulation*, Proc. Natl. Acad. Sci USA, **78**, 5275-5278 (1981).
273. K.E. Drexler, *Engines of Creation*, Anchor Press, Garden City, New York, (1986).
274. D.M. Eigler and E.K. Schweizer, *Positioning single atoms with a scanning electron microscope*, Nature, **344**, 524-526 (1990).
275. E.D. Gilbert, editor, *Miniaturization*, Reinhold, New York, (1961).
276. R.C. Haddon and A.A. Lamola, *The molecular electronic devices and the biochip computer: present status*, Proc. Natl. Acad. Sci. USA, **82**, 1874-1878 (1985).
277. H.M. Hastings and S. Waner, *Low dissipation computing in biological systems*, BioSystems, **17**, 241-244 (1985).

278. J.J. Hopfield, J.N. Onuchic and D.N. Beritan, *A molecular shift register based on electron transfer*, *Science*, **241**, 817-820 (1988).
279. L. Keszthelyi, *Bacteriorhodopsin*, in *Bioenergetics*, P. P. Graber and G. Millazo (editors), Birkhäuser Verlag, Basel Switzerland, (1997).
280. F.T. Hong, *The bacteriorhodopsin model membrane as a prototype molecular computing element*, *BioSystems*, **19**, 223-236 (1986).
281. L.E. Kay, *Life as technology: Representing, intervening and molecularizing*, *Rivista di Storia della Scienza*, **II**, **1**, 85-103 (1993).
282. A.P. Alivisatos et al., *Organization of 'nanocrystal molecules' using DNA*, *Nature*, **382**, 609-611, (1996).
283. T. Bjørnholm et al., *Self-assembly of regioregular, amphiphilic polythiophenes into highly ordered pi-stacked conjugated thin films and nanocircuits*, *J. Am. Chem. Soc.* **120**, 7643 (1998).
284. L.J. Fogel, A.J.Owens, and M.J. Walsh, *Artificial Intelligence Through Simulated Evolution*, John Wiley, New York, (1966).
285. L.J. Fogel, *A retrospective view and outlook on evolutionary algorithms*, in *Computational Intelligence: Theory and Applications*, in *5th Fuzzy Days*, B. Reusch, editor, Springer-Verlag, Berlin, (1997).
286. P.J. Angeline, *Multiple interacting programs: A representation for evolving complex behaviors*, *Cybernetics and Systems*, **29** (8), 779-806 (1998).
287. X. Yao and D.B. Fogel, editors, *Proceedings of the 2000 IEEE Symposium on Combinations of Evolutionary Programming and Neural Networks*, IEEE Press, Piscataway, NJ, (2001).
288. R.M. Brady, *Optimization strategies gleaned from biological evolution*, *Nature* **317**, 804-806 (1985).
289. K. Dejong, *Adaptive system design - a genetic approach*, *IEEE Syst. M.* **10**, 566-574 (1980).
290. W.B. Dress, *Darwinian optimization of synthetic neural systems*, *IEEE Proc. ICNN* **4**, 769-776 (1987).
291. J.H. Holland, *A mathematical framework for studying learning in classifier systems*, *Physica* **22 D**, 307-313 (1986).
292. R.F. Albrecht, C.R. Reeves, and N.C. Steele (editors), *Artificial Neural Nets and Genetic Algorithms*, Springer Verlag, (1993).
293. L. Davis, editor, *Handbook of Genetic Algorithms*, Van Nostrand Reinhold, New York, (1991).
294. Z. Michalewicz, *Genetic Algorithms + Data Structures = Evolution Programs*, Springer-Verlag, New York, (1992), second edition, (1994).
295. K.I. Diamantaris and S.Y. Kung, *Principal Component Neural Networks: Theory and Applications*, John Wiley and Sons, New York, (1996).
296. A. Garliauskas and A. Soliunas, *Learning and recognition of visual patterns by human subjects and artificial intelligence systems*, *Informatica*, **9** (4), (1998).
297. A. Garliauskas, *Numerical simulation of dynamic synapse-dendrite-soma neuronal processes*, *Informatica*, **9** (2), 141-160, (1998).

298. U. Seifert and B. Michaelis, *Growing multi-dimensional self-organizing maps*, International Journal of Knowledge-Based Intelligent Engineering Systems, **2** (1), 42-48, (1998).
299. S. Mitra, S.K. Pal, and M.K. Kundu, *Finger print classification using fuzzy multi-layer perceptron*, Neural Computing and Applications, **2**, 227-233 (1994).
300. M. Verleysen (editor), *European Symposium on Artificial Neural Networks*, D-Facto, (1999).
301. R.M. Golden, *Mathematical Methods for Neural Network Analysis and Design*, MIT Press, Cambridge MA, (1996).
302. S. Haykin, *Neural Networks - (A) Comprehensive Foundation*, MacMillan, New York, (1994).
303. M.A. Gronroos, *Evolutionary Design of Neural Networks*, Thesis, Computer Science, Department of Mathematical Sciences, University of Turku, Finland, (1998).
304. D.E. Goldberg, *Genetic Algorithms in Search, Optimization and Machine Learning*, Addison-Wesley, (1989).
305. M. Mitchell, *An Introduction to Genetic Algorithms*, MIT Press, Cambridge MA, (1996).
306. L. Davis (editor), *Handbook of Genetic Algorithms*, Van Nostrand and Reinhold, New York, (1991).
307. J.H. Holland, *Adaptation in Natural and Artificial Systems*, MIT Press, Cambridge MA, (1992).
308. J.H. Holland, *Hidden Order; How Adaptation Builds Complexity*, Addison Wesley, (1995).
309. W. Banzhaf, P. Nordin, R.E. Keller and F. Francone, *Genetic Programming - An Introduction; On the Automatic Evolution of Computer Programs and its Applications*, Morgan Kaufmann, San Francisco CA, (1998).
310. W. Banzhaf et al. (editors), *(GECCO)-99: Proceedings of the Genetic Evolutionary Computation Conference*, Morgan Kaufman, San Francisco CA, (2000).
311. W. Banzhaf, *Editorial Introduction, Genetic Programming and Evolvable Machines*, **1**, 5-6, (2000).
312. W. Banzhaf, *The artificial evolution of computer code*, *IEEE Intelligent Systems*, **15**, 74-76, (2000).
313. J.J. Grefenstette (editor), *Proceedings of the Second International Conference on Genetic Algorithms and their Applications*, Lawrence Erlbaum Associates, Hillsdale New Jersey, (1987).
314. J. Koza, *Genetic Programming: On the Programming of Computers by means of Natural Selection*, MIT Press, Cambridge MA, (1992).
315. J. Koza et al., editors, *Genetic Programming 1997: Proceedings of the Second Annual Conference*, Morgan Kaufmann, San Francisco, (1997).
316. W.B. Langdon, *Genetic Programming and Data Structures*, Kluwer, (1998).
317. D. Lundh, B. Olsson, and A. Narayanan, editors, *Bio-Computing and Emergent Computation 1997*, World Scientific, Singapore, (1997).

318. P. Angeline and K. Kinnear, editors, *Advances in Genetic Programming: Volume 2*, MIT Press, (1997).
319. J.H. Holland, *Adaptation in Natural and Artificial Systems*, The University of Michigan Press, Ann Arbor, (1975).
320. David B. Fogel and Wirt Atmar (editors), *Proceedings of the First Annual Conference on Evolutionary Programming*, Evolutionary Programming Society, La Jolla California, (1992).
321. M. Sipper et al., *A phylogenetic, ontogenetic, and epigenetic view of bioinspired hardware systems*, IEEE Transactions in Evolutionary Computation **1**, 1 (1997).
322. E. Sanchez and M. Tomassini, editors, *Towards Evolvable Hardware*, Lecture Notes in Computer Science, 1062, Springer-Verlag, (1996).
323. J. Markoff, *A Darwinian creation of software*, New York Times, Section C, p.6, February 28, (1990).
324. A. Thompson, *Hardware Evolution: Automatic design of electronic circuits in reconfigurable hardware by artificial evolution*, Distinguished dissertation series, Springer-Verlag, (1998).
325. W. McCulloch and W. Pitts, *A Logical Calculus of the Ideas Immanent in Nervous Activity*, Bulletin of Mathematical Biophysics, **7**, 115-133, (1943).
326. F. Rosenblatt, *Principles of Neurodynamics*, Spartan Books, (1962).
327. C. von der Malsburg, *Self-Organization of Orientation Sensitive Cells in the Striate Cortex*, Kybernetik, **14**, 85-100, (1973).
328. S. Grossberg, *Adaptive Pattern Classification and Universal Recoding: 1. Parallel Development and Coding of Neural Feature Detectors*, Biological Cybernetics, **23**, 121-134, (1976).
329. J.J. Hopfield and D.W. Tank, *Computing with Neural Circuits: A Model*, Science, **233**, 625-633, (1986).
330. R.D. Beer, *Intelligence as Adaptive Behavior: An Experiment in Computational Neuroethology*, Academic Press, New York, (1990).
331. S. Haykin, *Neural Networks: A Comprehensive Foundation*, IEEE Press and Macmillan, (1994).
332. S.V. Kartalopoulos, *Understanding Neural Networks and Fuzzy Logic: Concepts and Applications*, IEEE Press, (1996).
333. D. Fogel, *Evolutionary Computation: The Fossil Record*, IEEE Press, (1998).
334. D. Fogel, *Evolutionary Computation: Toward a New Philosophy of Machine Intelligence*, IEEE Press, Piscataway NJ, (1995).
335. J.M. Zurada, R.J. Marks II, and C.J. Robinson, editors, *Computational Intelligence: Imitating Life*, IEEE Press, (1994).
336. J. Bezdek and S.K. Pal, editors, *Fuzzy Models for Pattern Recognition: Methods that Search for Structure in Data*, IEEE Press, (1992).
337. M.M. Gupta and G.K. Knopf, editors, *Neuro-Vision Systems: Principles and Applications*, IEEE Press, (1994).
338. C. Lau, editor, *Neural Networks. Theoretical Foundations and Analysis*, IEEE Press, (1992).

339. T. Back, D.B. Fogel and Z. Michalewicz, editors, *Handbook of Evolutionary Computation*, Oxford University Press, (1997).
340. D.E. Rumelhart and J.L. McClelland, *Parallel Distributed Processing: Explorations in the Micro structure of Cognition, Volumes I and II*, MIT Press, (1986).
341. J. Hertz, A. Krogh and R.G. Palmer, *Introduction to the Theory of Neural Computation*, Addison Wesley, (1991).
342. J.A. Anderson and E. Rosenfeld, *Neurocomputing: Foundations of Research*, MIT Press, (1988).
343. R.C. Eberhart and R.W. Dobbins, *Early neural network development history: The age of Camelot*, IEEE Engineering in Medicine and Biology **9**, 15-18 (1990).
344. T. Kohonen, *Self-Organization and Associative Memory*, Springer-Verlag, Berlin, (1984).
345. T. Kohonen, *Self-Organizing Maps*, Springer-Verlag, Berlin, (1997).
346. G.E. Hinton, *How neural networks learn from experience*, Scientific American **267**, 144-151 (1992).
347. K. Swingler, *Applying Neural Networks: A Practical Guide*, Academic Press, New York, (1996).
348. B.K. Wong, T.A. Bodnovich and Y. Selvi, *Bibliography of neural network business applications research: 1988-September 1994*, Expert Systems **12**, 253-262 (1995).
349. I. Kaastra and M. Boyd, *Designing neural networks for forecasting financial and economic time series*, Neurocomputing **10**, 251-273 (1996).
350. T. Poddig and H. Rehkugler, *A world model of integrated financial markets using artificial neural networks*, Neurocomputing **10**, 2251-273 (1996).
351. J.A. Burns and G.M. Whiteside, *Feed forward neural networks in chemistry: Mathematical systems for classification and pattern recognition*, Chem. Rev. **93**, 2583-2601, (1993).
352. M.L. Action and P.W. Wilding, *The application of backpropagation neural networks to problems in pathology and laboratory medicine*, Arch. Pathol. Lab. Med. **116**, 995-1001 (1992).
353. D.J. Maddalena, *Applications of artificial neural networks to problems in quantitative structure activity relationships*, Exp. Opin. Ther. Patents **6**, 239-251 (1996).
354. W.G. Baxt, *Application of artificial neural networks to clinical medicine*, [Review], Lancet **346**, 1135-8 (1995).
355. A. Chablo, *Potential applications of artificial intelligence in telecommunications*, Technovation **14**, 431-435 (1994).
356. D. Horwitz and M. El-Sibaie, *Applying neural nets to railway engineering*, AI Expert, 36-41, January (1995).
357. J. Plummer, *Tighter process control with neural networks*, 49-55, October (1993).
358. T. Higuchi et al., *Proceedings of the First International Conference on Evolvable Systems: From Biology to Hardware (ICES96)*, Lecture Notes on Computer Science, Springer-Verlag, (1997).
359. S.A. Kaufman, *Antichaos and adaption*, Scientific American, **265**, 78-84, (1991).
360. S.A. Kauffman, *The Origins of Order*, Oxford University Press, (1993).

361. M.M. Waldrop, *Complexity: The Emerging Science at the Edge of Order and Chaos*, Simon and Schuster, New York, (1992).
362. H.A. Simon, *The Science of the Artificial, 3rd Edition*, MIT Press, (1996).
363. M.L. Hooper, *Embryonic Stem Cells: Introducing Planned Changes into the Animal Germline*, Harwood Academic Publishers, Philadelphia, (1992).
364. F. Grosveld, (editor), *Transgenic Animals*, Academic Press, New York, (1992).
365. G. Kohler and C. Milstein, *Continuous cultures of fused cells secreting antibody of predefined specificity*, *Nature*, **256**, 495-497 (1975).
366. S. Spiegelman, *An approach to the experimental analysis of precellular evolution*, *Quarterly Reviews of Biophysics*, **4**, 213-253 (1971).
367. M. Eigen, *Self-organization of matter and the evolution of biological macromolecules*, *Naturwissenschaften*, **58**, 465-523 (1971).
368. M. Eigen and W. Gardiner, *Evolutionary molecular engineering based on RNA replication*, *Pure and Applied Chemistry*, **56**, 967-978 (1984).
369. G.F. Joyce, *Directed molecular evolution*, *Scientific American* **267** (6), 48-55 (1992).
370. N. Lehman and G.F. Joyce, *Evolution in vitro of an RNA enzyme with altered metal dependence*, *Nature*, **361**, 182-185 (1993).
371. E. Culotta, *Forcing the evolution of an RNA enzyme in the test tube*, *Science*, **257**, 31 July, (1992).
372. S.A. Kauffman, *Applied molecular evolution*, *Journal of Theoretical Biology*, **157**, 1-7 (1992).
373. H. Fenniri, *Combinatorial Chemistry. A Practical Approach*, Oxford University Press, (2000).
374. P. Seneci, *Solid-Phase Synthesis and Combinatorial Technologies*, John Wiley & Sons, New York, (2001).
375. G.B. Fields, J.P. Tam, and G. Barany, *Peptides for the New Millennium*, Kluwer Academic Publishers, (2000).
376. Y.C. Martin, *Diverse viewpoints on computational aspects of molecular diversity*, *Journal of Combinatorial Chemistry*, **3**, 231-250, (2001).
377. C.G. Langton et al., editors, *Artificial Life II: Proceedings of the Workshop on Artificial Life Held in Santa Fe, New Mexico*, Addison-Wesley, Reading MA, (1992).
378. W. Aspray and A. Burks, eds., *Papers of John von Neumann on Computers and Computer Theory*, MIT Press, (1967).
379. M. Conrad and H.H. Pattee, *Evolution experiments with an artificial ecosystem*, *J. Theoret. Biol.*, **28**, (1970).
380. C. Emmeche, *Life as an Abstract Phenomenon: Is Artificial Life Possible?*, in *Toward a Practice of Artificial Systems: Proceedings of the First European Conference on Artificial Life*, MIT Press, Cambridge MA, (1992).
381. C. Emmeche, *The Garden in the Machine: The Emerging Science of Artificial Life*, Princeton University Press, Princeton NJ, (1994).
382. S. Levy, *Artificial Life: The Quest for New Creation*, Pantheon, New York, (1992).
383. K. Lindgren and M.G. Nordahl, *Cooperation and Community Structure in Artificial Ecosystems*, *Artificial Life*, **1**, 15-38 (1994).

384. P. Husbands and I. Harvey (editors), *Proceedings of the 4th Conference on Artificial Life (ECAL '97)*, MIT Press, (1997).
385. C.G. Langton, (editor), *Artificial Life: An Overview*, MIT Press, Cambridge MA, (1997).
386. C.G. Langton, ed., *Artificial Life*, Addison-Wesley, (1987).
387. A.A. Beaudry and G.F. Joyce, *Directed evolution of an RNA enzyme*, *Science*, **257**, 635-641 (1992).
388. D.P. Bartel and J.W. Szostak, *Isolation of new ribozymes from a large pool of random sequences*, *Science*, 261, 1411-1418 (1993).
389. K. Kelly, *Out of Control*, www.kk.org/outofcontrol/index.html, (2002).
390. K. Kelly, *The Third Culture*, *Science*, February 13, (1998).
391. S. Blakeslee, *Computer life-form "mutates" in an evolution experiment, natural selection is found at work in a digital world*, *New York Times*, November 25, (1997).
392. M. Ward, *It's life, but not as we know it*, *New Scientist*, July 4, (1998).
393. P. Guinnessy, *"Life" crawls out of the digital soup*, *New Scientist*, April 13, (1996).
394. L. Hurst and R. Dawkins, *Life in a test tube*, *Nature*, May 21, (1992).
395. J. Maynard Smith, *Byte-sized evolution*, *Nature*, February 27, (1992).
396. W.D. Hillis, *Intelligence as an Emergent Behavior*, in *Artificial Intelligence*, S. Graubard, ed., MIT Press, (1988).
397. T.S. Ray, *Evolution and optimization of digital organisms*, in *Scientific Excellence in Supercomputing: The IBM 1990 Contest Prize Papers*, K.R. Billingsly, E. Derohanes, and H. Brown, III, editors, The Baldwin Press, University of Georgia, Athens GA 30602, (1991).
398. S. Lloyd, *The calculus of intricacy*, *The Sciences*, October, (1990).
399. M. Minsky, *The Society of Mind*, Simon and Schuster, (1985).
400. D. Pines, ed., *Emerging Synthesis in Science*, Addison-Wesley, (1988).
401. P. Prusinkiewicz and A. Lindenmayer, *The Algorithmic Beauty of Plants*, Springer-Verlag, (1990).
402. T. Tommaso and N. Margolus, *Cellular Automata Machines: A New Environment for Modeling*, MIT Press, (1987).
403. W.M. Mitchell, *Complexity: The Emerging Science at the Edge of Order and Chaos*, Simon and Schuster, (1992).
404. T.S. Ray et al., *Kurzweil's Turing Fallacy, in Are We Spiritual Machines?: Ray Kurzweil vs. the Critics of Strong AI*, J. Richards, ed., Viking, (2002).
405. T.S. Ray, *Aesthetically Evolved Virtual Pets*, in *Artificial Life 7 Workshop Proceedings*, C.C. Maley and E. Bordreau, eds., (2000).
406. T.S. Ray and J.F. Hart, *Evolution of Differentiation in Digital Organisms*, in *Artificial Life VII, Proceedings of the Seventh International Conference on Artificial Life*, M.A. Bedau, J.S. McCaskill, N.H. Packard, and S. Rasmussen, eds., MIT Press, (2000).
407. T.S. Ray, *Artificial Life, in Frontiers of Life, Vol. 1: The Origins of Life*, R. Dulbecco et al., eds., Academic Press, (2001).

408. T.S. Ray, *Selecting naturally for differentiation: Preliminary evolutionary results*, *Complexity*, **3 (5)**, John Wiley and Sons, (1998).
409. K. Sims, *Artificial Evolution for Computer Graphics*, *Computer Graphics*, **25 (4)**, 319-328 (1991).
410. K. Sims, Galapagos, <http://web.genarts.com/galapagos> , (1997).

Chapter 8

SPACE EXPLORATION

8.1 Astronautics

Rocket timeline from Wikipedia

- 11th century AD - The first documented record of gunpowder and the fire arrow, an early form of rocketry, appears in the Chinese text *Wujing Zongyao*.
- 1650 - *Artis Magnae Artilleriae pars prima* (“Great Art of Artillery, the First Part”) is printed in Amsterdam, about a year before the death of its author, Kazimierz Siemienowicz.
- 1664 - A “space rocket” is imagined as a future technology to be studied in France and its drawing is ordered by French finance minister Colbert; designed by Le Brun on a Gobelins tapestry.
- 1798 - Tipu Sultan, the King of the state of Mysore in India, develops and uses iron rockets against the British Army.
- 1801 - The British Army develops the Congreve rocket based on weapons used against them by Tipu Sultan.
- 1806 - Claude Ruggieri, an Italian living in France, launched animals on rockets and recovered them using parachutes. He was prevented from launching a child by police.
- 1813 - “A Treatise on the Motion of Rockets” by William Moore - first appearance of the rocket equation.
- 1818 - Henry Trengrouse demonstrates his rocket apparatus for projecting a lifeline from a wrecked ship to the shore, later widely adopted.
- 1844 - William Hale invents the spin-stabilized rocket
- 1861 - William Leitch publishes an essay “A Journey Through Space” as a humorous science fantasy story about a space gun launching a manned spacecraft equipped with rockets for landing on the Moon, but eventually used for another orbital maneuver.



Figure 8.1: A jet-driven steam engine invented by Hero of Alexandria in the 1st century A.D..



Figure 8.2: Rockets were used in warfare in China in the 11th century.



Figure 8.3: Congreve rockets were used in the bombardment of Copenhagen in 1807. It was a terror attack on the civilian population, carried out although no state of war existed between Denmark and England.



Figure 8.4: The Nazi V2 rocket, which launched the space age, was also used for the terror bombardment of civilians.

- 1902 - French cinema pioneer Georges Méliés directs *A Trip to the Moon*, the first film about space travel.
- 1903 - Konstantin Tsiolkovsky begins a series of papers discussing the use of rocketry to reach outer space, space suits, and colonization of the Solar System. Two key points discussed in his works are liquid fuels and staging.
- 1913 - Without knowing the work of Russian mathematician Konstantin Tsiolkovsky, French engineer Robert Esnault-Pelterie derived the equations for space flight, produced a paper that presented the rocket equation and calculated the energies required to reach the Moon and nearby planets.
- 1916 - first use of rockets (with the solid fuel Le Prieur rocket) for both air-to-air attacks, and air to ground.
- 1922 - Hermann Oberth publishes his scientific work about rocketry and space exploration: *Die Rakete zu den Planetenräumen* ("By Rocket into Planetary Space").
- 1924 - Society for Studies of Interplanetary Travel founded in Moscow by Konstantin Tsiolkovsky, Friedrich Zander and 200 other space and rocket experts
- 1926 - Robert Goddard launches the first liquid fuel rocket. This is considered by some to be the start of the Space Age.
- 1927 - Verein für Raumschiffahrt (VfR - "Spaceflight Society") founded in Germany.
- 1929 - *Woman in the Moon*, considered to be one of the first "serious" science fiction films.
- 1931 - Friedrich Schmiedl attempts the first rocket mail service in Austria
- 1933 - Sergei Korolev and Mikhail Tikhonravov launch the first liquid-fueled rocket in the Soviet Union.
- 1935 - Emilio Herrera Linares from Spain designed and made the first full-pressured astronaut suit, called the *escafandra estratonáutica*. The Russians then used a model of Herrera's suit when first flying into space of which the Americans would then later adopt when creating their own space program.
- 1936 - Research on rockets begins at the Guggenheim Aeronautical Laboratory at the California Institute of Technology (GALCIT), the predecessor to the Jet Propulsion Laboratory, under the direction of Frank Malina and Theodore von Kármán.
- 1937 - Peenemünde Army Research Center founded in Germany.
- 1938 - The Projectile Development Establishment founded at Fort Halstead for the United Kingdom's research into military solid-fuel rockets.
- 1939 - Katyusha multiple rocket launchers are a type of rocket artillery first built and fielded by the Soviet Union.

- 1941 - French rocket EA-41 is launched, being the first European liquid propellant working rocket[8](It was, however, preceded by the Peenemünde A5 and Soviet experiments.)
- 1941 - Jet Assisted Take Off JATO installed on US Army Air Corp Ercoupe aircraft occurred on 12 August in March Field, California.
- 1942 - Wernher von Braun and Walter Dornberger launch the first V-2 rocket at Peenemünde in northern Germany.
- 1942 - A V-2 rocket reaches an altitude of 85 km.
- 1944 - The V-2 rocket MW 18014 reaches an altitude of 176 km, becoming the first man-made object in space.
- 1945 - Lothar Sieber dies after the first vertical take-off manned rocket flight in a Bachem Ba 349 “Natter”.
- 1945 - Operation Paperclip takes 1,600 German rocket scientists and technicians to the United States.
- 1945 - Operation Osoaviakhim takes 2,000 German rocket scientists and technicians to the Soviet Union.
- 1946 - First flight of the Nike missile, later the first operational surface-to-air guided missile.
- 1947 - Chuck Yeager achieves the first manned supersonic flight in a Bell X-1 rocket-powered aircraft.
- 1949 - Willy Ley publishes *The Conquest of Space*.
- 1952 - 22 May, French Véronique 1 rocket is launched from the Algerian desert.
- 1952 - Wernher von Braun discusses the technical details of a manned exploration of Mars in *Das Marsprojekt*.
- 1953 - *Colliers* magazine publishes a series of articles on man’s future in space, igniting the interest of people around the world. The series includes numerous articles by Ley and von Braun, illustrated by Chesley Bonestell.
- 1956 - First launch of PGM-17 Thor, the first US ballistic missile and forerunner of the Delta space launch rockets.
- 1957 - Launch of the first ICBM, the USSR’s R-7 (8K71), known to NATO as the SS-6 Sapwood.
- 1957 - The USSR launches Sputnik 1, the first artificial satellite.
- 1958 - The U.S. launches Explorer 1, the first American artificial satellite, on a Jupiter-C rocket.
- 1958 - US launches their first ICBM, the Atlas-B (the Atlas-A was a test article only).
- 1961 - the USSR launches Vostok 1, Yuri Gagarin reached a height of 327 km above Earth and was the first man to orbit Earth.
- 1961 - US, a Mercury capsule named Freedom 7 with Alan B. Shepard, spacecraft was launched by a Redstone rocket on a ballistic trajectory suborbital flight. It was the first human space mission that landed with pilot still in spacecraft, thus the first complete human spaceflight by FAI definitions.

- 1962 - The US launches Mercury MA-6 (Friendship 7) on an Atlas D booster, John Glenn puts America in orbit.
- 1963 - The USSR launches Vostok 6, Valentina Tereshkova was the first woman (and first civilian) to orbit Earth. She remained in space for nearly three days and orbited the Earth 48 times.
- 1963 - US X-15 rocket-plane, the first reusable manned spacecraft (sub-orbital) reaches space, pioneering reusability, carried launch and glide landings.
- 1965 - USSR Proton rocket, highly successful launch vehicle with notable payloads, Salyut 6 and Salyut 7, Mir, and ISS components.
- 1965 - Robert Salked investigates various single stage to orbit spaceplane concepts.
- 1966 - USSR Luna 9, the first soft landing on the Moon.
- 1966 - USSR launches Soyuz spacecraft, longest-running series of spacecraft, eventually serving Soviet, Russian and International space missions.
- 1968 - USSR Zond 5, two tortoises and smaller biological Earthlings circle the Moon and return safely to Earth.
- 1968 - US Apollo 8, the first men to reach and orbit the Moon.
- 1969 - US Apollo 11, first men on the Moon, first lunar surface extravehicular activity.
- 1981 - US Space Shuttle pioneers reusability and glide landings.
- 1998 - US Deep Space 1 is first deep space mission to use an ion thruster for propulsion.
- 1998 - Russia launch Zarya module which is the first part of the International Space Station.
- 2001 - Russian Soyuz spacecraft sent the first space tourist Dennis Tito to International Space Station.
- 2004 - US-based, first privately developed, manned (suborbital) spaceflight, SpaceShipOne demonstrates reusability.
- 2008 - SpaceX - with their Falcon 1 rocket - became the first private entity to successfully launch a rocket into orbit.
- 2012 - The SpaceX Dragon space capsule - launched aboard a Falcon 9 launch vehicle - was the first private spacecraft to successfully dock with another spacecraft, and was also the first private capsule to dock at the International Space Station.
- 2014 - First booster rocket returning from an orbital trajectory to achieve a zero-velocity-at-zero-altitude propulsive vertical landing. The first-stage booster of Falcon 9 Flight 9 made the first successful controlled ocean soft touchdown of a liquid-rocket-engine orbital booster on April 18, 2014.
- 2015 - SpaceX's Falcon 9 Flight 20 was the first time that the first stage of an orbital rocket made a successful return and vertical landing.
- 2017 - SpaceX's Falcon 9 SES-10 was the first time a used orbital rocket made a successful return.



Figure 8.5: **Cosmonaut Yuri Gagarin (1934-1968) was the first man in space. On 12 April, 1961, his space capsule, Vostok 1, completed an orbit of the Earth. Gagarin became an international celebrity, and was awarded many honors and medals. He died in the crash of a routine MIG-15UTI training flight.**

8.2 Exploration of the Earth's Moon

In ancient times, the Greek philosopher Anaxagoras, who died in 428 BC, believed the Moon to be a giant spherical rock that reflects the light of the sun. This non-religious view of the heavens caused Anaxagoras to be persecuted and banished.

Aristarchus of Samos (c.310-c.230 BC), calculated the size of the Moon and its distance from the Earth (by observing the shadow of the Earth on the Moon during an eclipse, and the angles involved). He also calculated the distance from the Earth to the Sun. The values that he obtained were not very accurate, but they showed the Sun to be enormous in size in relation to the Earth and the Moon. As a result of his calculations he became the first person to suggest a sun-centered model for the solar system.

In our own era, the Soviet Union was the first to send a rocket to the Moon, the unmanned rocket Luna 2. which made a hard landing in September, 1959. Another Soviet rocket, Luna 3, photographed the far side of the moon in October of the same year.

These and other Soviet successes initiated a “space race” between the United States and the Soviet Union, and caused President John F. Kennedy to say to Congress, “...I believe that this nation should commit itself to achieving the goal, before this decade is out, of landing a man on the Moon and returning him safely to the Earth. No single space project in this period will be more impressive to mankind, or more important in the long-range exploration of space; and none will be so difficult or expensive to accomplish.”

In December, 1968, the crew of Apollo 8 became the first humans to enter a lunar

orbit and to see the far side of the Moon. This success was followed by Apollo 11, in July, 1969, a manned spacecraft that made a soft landing on the Moon. Niel Armstrong, the commander of the mission, became, famously, the first human to set foot on the Moon.

In 1970, the first lunar robot vehicle landed on the Moon. It was sent by the Soviet Union and called "Lunokhod 1".

The manned Apollo missions were eventually abandoned by the United States, but the National Aeronautics and Space Administration (NASA) has continued to send missions to photograph the Moon. Some of the photographs are shown below.

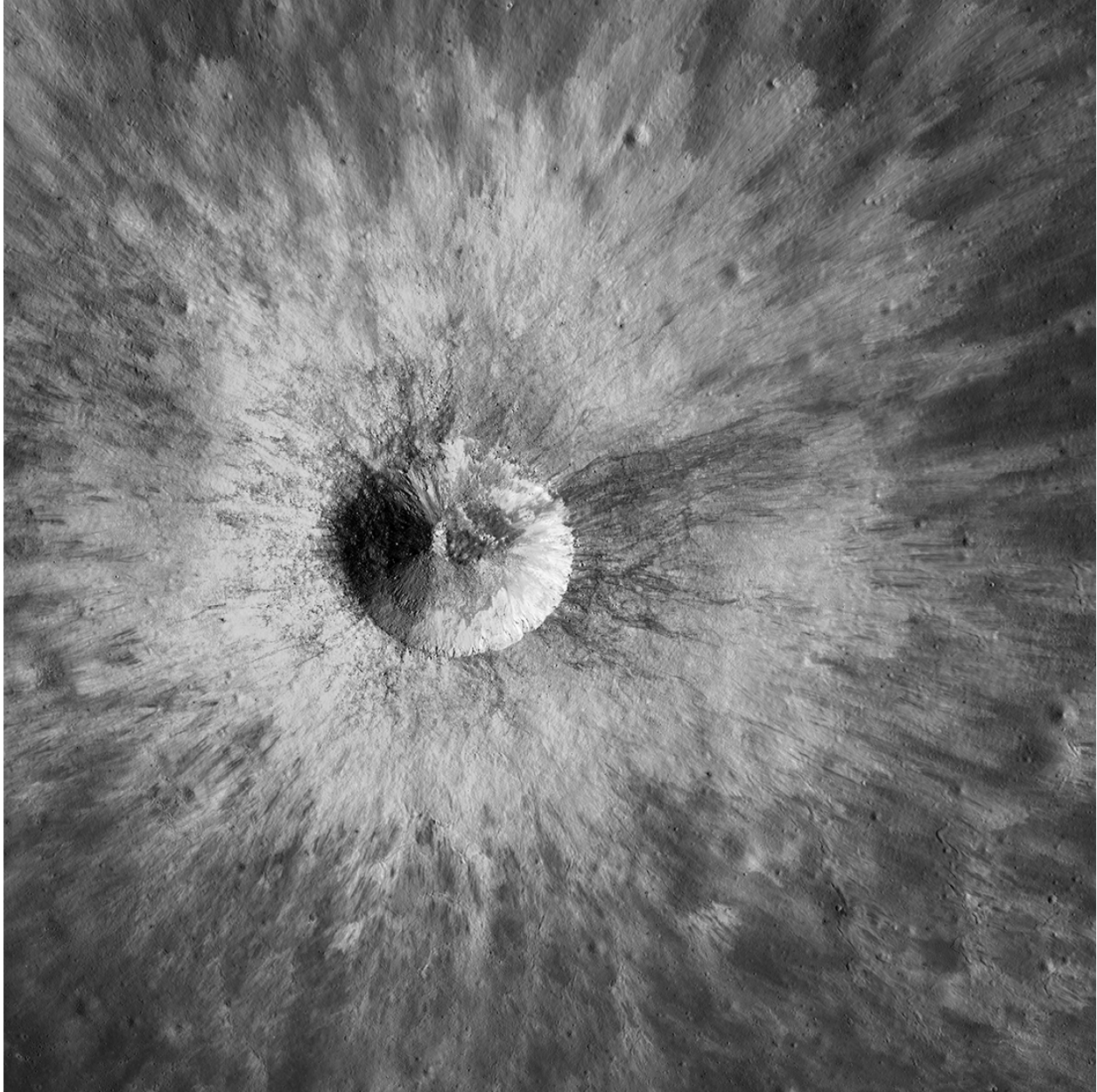

Figure 8.6: A young ray impact crater blasted in the eroded wall of the partly buried crater Hedin. It is distant from the starkly beautiful landscape Armstrong saw: the Apollo 11 landing site on Mare Tranquillitatis is more than 1000 kilometers to the east (NASA/GSFC/Arizona State University, November 3, 2018).

8.3 Missions to Mars

Below we list a few of the many missions to Mars:

- Mars 4NM and Mars 5NM - projects intended by the Soviet Union for heavy Marsokhod (in 1973 according to initial plan of 1970) and Mars sample return (planned for 1975). The missions were to be launched on the failed N1 rocket.
- Mars 5M (Mars-79) - double-launching Soviet sample return mission planned to 1979 but cancelled due to complexity and technical problems
- Voyager-Mars - USA, 1970s - Two orbiters and two landers, launched by a single Saturn V rocket.
- Vesta - the multi-aimed Soviet mission, developed in cooperation with European countries for realization in 1991-1994 but canceled due to the Soviet Union disbanding, included the flyby of Mars with delivering the aerostat and small landers or penetrators followed by flybys of 1 Ceres or 4 Vesta and some other asteroids with impact of penetrator on the one of them.
- Mars Aerostat - Russian/French balloon part for cancelled Vesta mission and then for failed Mars 96 mission,[71] originally planned for the 1992 launch window, postponed to 1994 and then to 1996 before being cancelled.
- Mars Together, combined U.S. and Russian mission study in the 1990s. To be launched by a Molinya with possible U.S. orbiter or lander.
- Mars Environmental Survey - set of 16 landers planned for 1999-2009
- Mars-98 - Russian mission including an orbiter, lander, and rover, planned for 1998 launch opportunity as repeat of failed Mars 96 mission and cancelled due to lack of funding.
- Mars Surveyor 2001 Lander - October 2001 - Mars lander (refurbished, became Phoenix lander)
- Kitty Hawk - Mars airplane micromission, proposed for December 17, 2003, the centennial of the Wright brothers' first flight. Its funding was eventually given to the 2003 Mars Network project.[76]
- NetLander - 2007 or 2009 - Mars netlanders
- Beagle 3 - 2009 British lander mission meant to search for life, past or present.
- Mars Telecommunications Orbiter - September 2009 - Mars orbiter for telecommunications
- Sky-Sailor - 2014 - Plane developed by Switzerland to take detailed pictures of Mars surface
- Mars Astrobiology Explorer-Cacher - 2018 rover concept, cancelled due to budget cuts in 2011. Sample cache goal later moved to Mars 2020 rover.

8.4 The Cassini-Huygens space probe

The Wikipedia article on Cassini-Huygens gives the following description of the probe:

The Cassini-Huygens space-research mission, commonly called Cassini, involved a collaboration between NASA, the European Space Agency (ESA), and the Italian Space Agency (ASI) to send a probe to study the planet Saturn and its system, including its rings and natural satellites. The Flagship-class robotic spacecraft comprised both NASA's Cassini probe and ESA's Huygens lander, which landed on Saturn's largest moon, Titan. Cassini was the fourth space probe to visit Saturn and the first to enter its orbit. The two craft took their names from the astronomers Giovanni Cassini and Christiaan Huygens.

Launched aboard a Titan IVB/Centaur on October 15, 1997, Cassini was active in space for nearly 20 years, with 13 years spent orbiting Saturn and studying the planet and its system after entering orbit on July 1, 2004. The voyage to Saturn included flybys of Venus (April 1998 and July 1999), Earth (August 1999), the asteroid 2685 Masursky, and Jupiter (December 2000). The mission ended on September 15, 2017, when Cassini's trajectory took it into Saturn's upper atmosphere and it burned up in order to prevent any risk of contaminating Saturn's moons, which might have offered habitable environments to stowaway terrestrial microbes on the spacecraft. The mission is widely perceived to have been successful beyond expectations. NASA's Planetary Science Division Director, Jim Green, described Cassini-Huygens as a "mission of firsts", that has revolutionized human understanding of the Saturn system, including its moons and rings, and our understanding of where life might be found in the Solar System.

Cassini's planners originally scheduled a mission of four years, from June 2004 to May 2008. The mission was extended for another two years until September 2010, branded the Cassini Equinox Mission. The mission was extended a second and final time with the Cassini Solstice Mission, lasting another seven years until September 15, 2017, on which date Cassini was de-orbited to burn up in Saturn's upper atmosphere.

The Huygens module traveled with Cassini until its separation from the probe on December 25, 2004; it landed by parachute on Titan on January 14, 2005. It returned data to Earth for around 90 minutes, using the orbiter as a relay. This was the first landing ever accomplished in the outer Solar System and the first landing on a moon other than Earth's Moon.

At the end of its mission, the Cassini spacecraft executed its "Grand Finale": a number of risky passes through the gaps between Saturn and Saturn's inner rings. This phase aimed to maximize Cassini's scientific outcome before the spacecraft was disposed. The atmospheric entry of Cassini ended the mission, but analyses of the returned data will continue for many years.

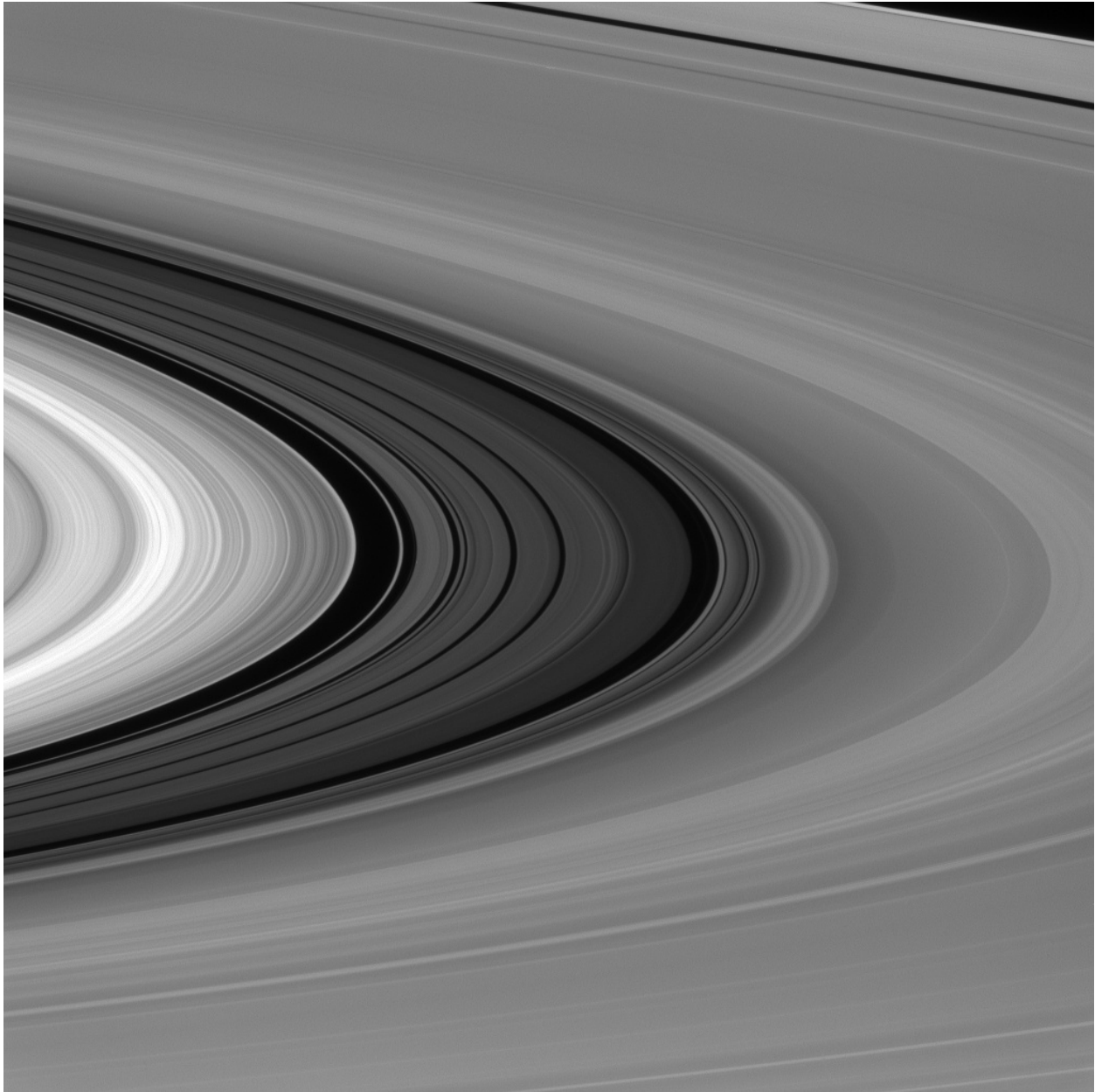

Figure 8.7: **The Great Divide:** It's difficult to get a sense of scale when viewing Saturn's rings, but the Cassini Division (seen here between the bright B ring and dimmer A ring) is almost as wide as the planet Mercury. The 2,980-mile-wide (4,800-kilometer-wide) division in Saturn's rings is thought to be caused by the moon Mimas. Particles within the division orbit Saturn almost exactly twice for every time that Mimas orbits, leading to a build-up of gravitational nudges from the moon. These repeated gravitational interactions sculpt the outer edge of the B ring and keep its particles from drifting into the Cassini Division.

Chapter 9

THE GLOBAL HUMAN FOOTPRINT

9.1 How many earths does it take to support us?

The total ecological footprint of humanity is a concept used to measure the relationship between the resources that humans demand from their environment, compared with the ability of nature to provide those resources. In recent years humans have been asking the earth to provide the with much more than the earth can regenerate. Our collective footprint on the face of nature has become too large.

Here are some quotations from the homepage of the Footprint Network organization:¹

“If a population’s Ecological Footprint exceeds the region’s biocapacity, that region runs an ecological deficit. Its demand for the goods and services that its land and seas can provide - fruits and vegetables, meat, fish, wood, cotton for clothing, and carbon dioxide absorption - exceeds what the region’s ecosystems can renew. A region in ecological deficit meets demand by importing, liquidating its own ecological assets (such as overfishing), and/or emitting carbon dioxide into the atmosphere. If a region’s biocapacity exceeds its Ecological Footprint, it has an ecological reserve.

“Conceived in 1990 by Mathis Wackernagel and William Rees at the University of British Columbia, the Ecological Footprint launched the broader Footprint movement, including the carbon Footprint, and is now widely used by scientists, businesses, governments, individuals, and institutions working to monitor ecological resource use and advance sustainable development.

“A rich introduction to the theory and practice of the approach is available in the book Ecological Footprint: Managing Our Biocapacity Budget (2019).”

¹<https://www.footprintnetwork.org/our-work/ecological-footprint/>

How many Earths does it take to support humanity?

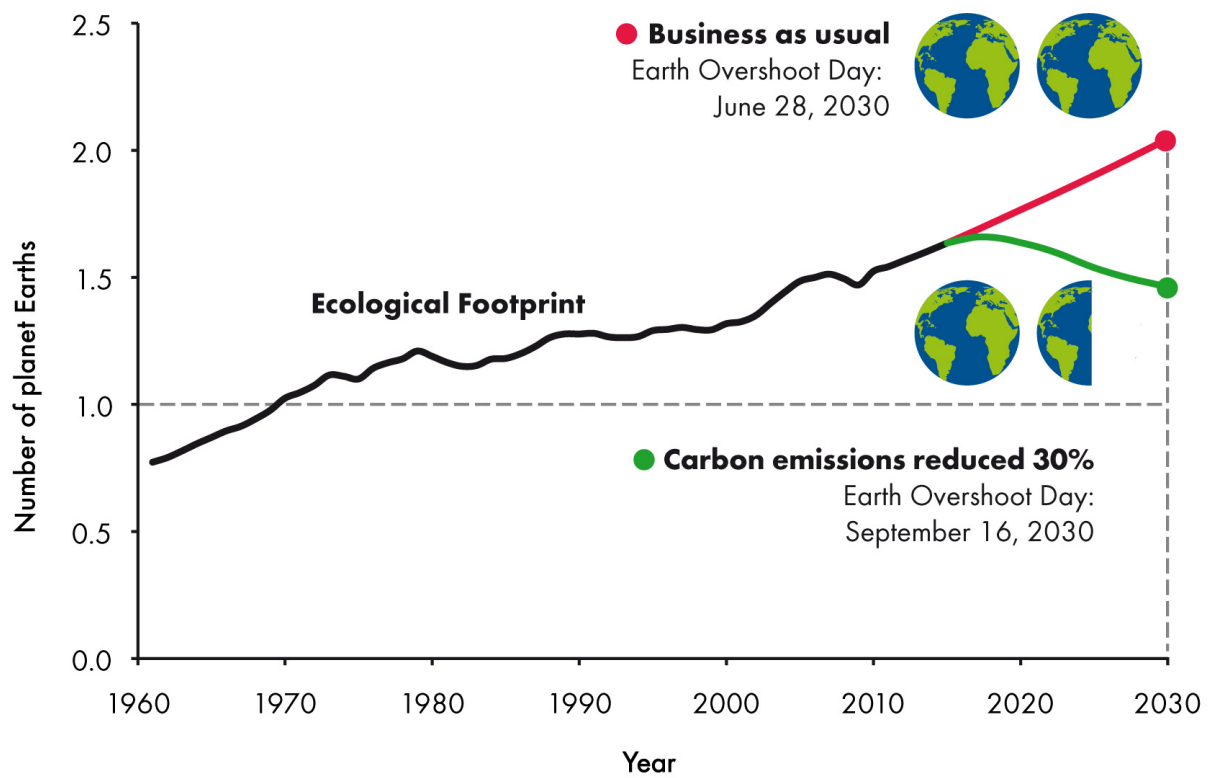

Figure 9.1: The business as usual course would lead us to disaster.

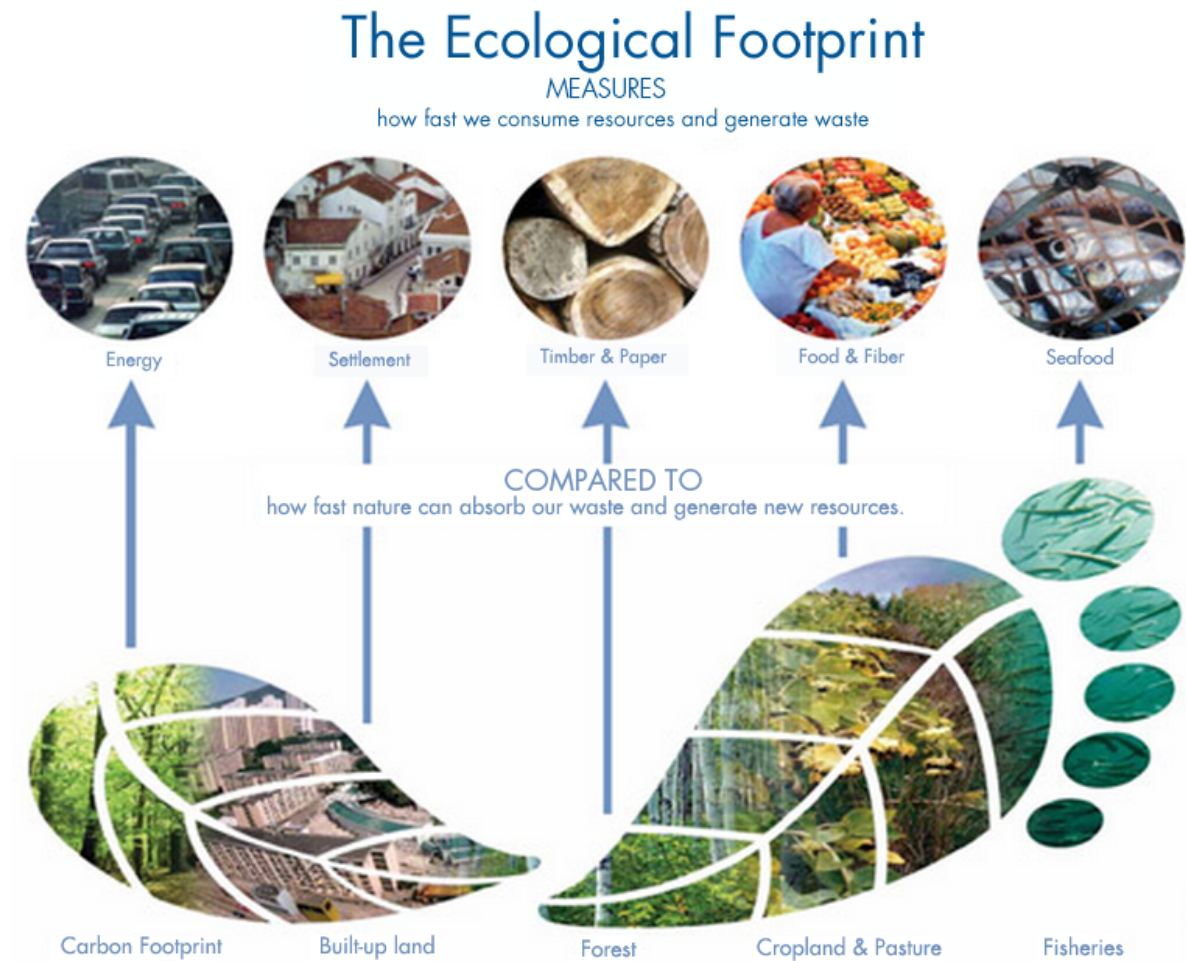

Figure 9.2: Both the Ecological Footprint and biocapacity are expressed in global hectares - globally comparable, standardized hectares with world average productivity.

9.2 Overuse of pesticides and the insect apocalypse

Loss of flying insects, especially bees

Studies have shown an annual decline of 5.2% in flying insect biomass found in nature reserves in Germany - about 75% loss in 26 years.

In the United States the managed bee populations have declined dramatically. According to one study, for the single year, from April 1, 2018, to April 1, 2019, the managed bee population decreased by 40.7%.

Overuse of pesticides degrades topsoil

It is not only the loss of bees and other pollinator insects that is dangerous to agriculture. The excessive use of pesticides and other agricultural chemicals also degrades topsoil. Normally, topsoil contains richly numerous and diverse populations of tiny worms and bacteria, that aid the recycling of crop residue from previous years into nutrients for plant growth. However, the overuse of pesticides and other agricultural chemicals kills these vitally important populations. Carbon from the dead topsoil is released into the atmosphere, thus increasing the concentrations of dangerous greenhouse gases. Having killed the living topsoil, farmers then find that they need increased quantities of petroleum-derived fertilizers to make their crops grow.

The Stockholm Convention on Persistent Organic Pollutants

An environmental treaty, signed in 2001 and effective since May, 2004, aims at restricting the production and use of persistent organic pollutants (POPs). These are defined by the United Nations Environmental Institute as “chemical substances that persist in the environment, bio-accumulate through the food web, and pose a risk of causing adverse effects to human health and the environment”. Besides DDT, the Stockholm Treaty also lists Aldrin, α -Hexachlorocyclohexane, β -Hexachlorocyclohexane, Chlordane, Chlordecone, Decabromodiphenyl ether, Dicofol, Dieldrin, Endosulfan, Endrin, Heptachlor, Hexabromobiphenyl, Hexabromocyclododecane, Hexabromodiphenylether, Hexachlorobenzene, Hexachlorobutadiene, Lindane, Mirex, Pentachlorobenzene, Pentachlorophenol, Perfluorooctanoic acid, Perfluorooctane sulfonic acid, Polychlorinated biphenyls, Polychlorinated dibenzodioxins, Polychlorinated naphthalenes, Tetrabromodiphenyl ether, Short-chain chlorinated paraffins, and Toxaphene.

Although some critics have claimed that the treaty is responsible for the continuing death toll from malaria, in reality it specifically permits the public health use of DDT for the control of malaria-carrying mosquitoes. In 2016, there were 216 million cases of malaria worldwide, resulting in an estimated 445,000 to 731,000 deaths.



Figure 9.3: 20 May 2019, Rome - The global decline in bee populations poses a serious threat to a wide variety of plants critical to human well-being and livelihoods, and countries should do more to safeguard our key allies in the fight against hunger and malnutrition, FAO stressed today as it marked UN World Bee Day. Bees and other pollinator are declining in abundance in many parts of the world largely due to intensive farming practices, mono-cropping, excessive use of agricultural chemicals and higher temperatures associated with climate change, affecting not only crop yields but also nutrition. If this trend continues, nutritious crops such as fruits, nuts, and many vegetables will be substituted increasingly by staple crops like rice, corn, and potatoes, eventually resulting in an imbalanced diet.

9.3 The Silent Spring

Dangers from pesticide pollution

Rachel Carson's most influential book, *The Silent Spring*, was published in 1962, when she was already suffering from breast cancer. Eventually it sold over two million copies. The book expresses Carson's worries about the environmental consequences of overuse of pesticides, such as DDT, which were killing not only their targeted pests, but also many vitally important insects, as well as causing health problems in humans. Part of the anger that Carson expressed in the book may have come because the cancer from which she was suffering could have been caused by mutagenic pesticides.

The town was fictitious, but the problems were real

The Silent Spring begins by describing a fictitious Midwestern American town, where people are mysteriously suffering and dying from a variety of unexplained illnesses previously unseen by doctors. Sheep and cattle, fish in the river, and birds, all sicken and die. Orchards bear no fruit and vegetation withers. It gradually becomes clear that the people of the town are themselves to blame. That have been poisoning themselves and their environment by overuse of pesticides.

Some quotations from *The Silent Spring*

Here are two quotations from the book:

As crude a weapon as the cave man's club, the chemical barrage has been hurled against the fabric of life - a fabric on the one hand delicate and destructible, on the other miraculously tough and resilient, and capable of striking back in unexpected ways... It is our alarming misfortune that so primitive a science has armed itself with the most modern and terrible weapons, and that in turning them against the insects it has also turned them against the earth...

Among the herbicides are some that are classified as 'mutagens,' or agents capable of modifying the genes, the materials of heredity. We are rightly appalled by the genetic effects of radiation; how then, can we be indifferent to the same effect in chemicals that we disseminate widely in our environment?

Although extremely ill with cancer and in constant pain, Carson gave newspaper interviews and appeared on television to make her case. In July, 1962, the US Department of agriculture issued the following statement: **"Miss Carson provides a lucid description of the real and potential dangers of misusing chemical pesticides... She expresses the concern of many people about the effect of chemical pesticides on birds, animals and people. We are fully aware of and share this concern."**

'Silent Spring' Is Now Noisy Summer

*Pesticides Industry
Up in Arms Over
a New Book*

By JOHN M. LEE

The \$200,000,000 pesticides industry has been highly irritated by a quiet woman author whose previous works on science have been praised for the beauty and precision of the writing.

The author is Rachel Carson, whose "The Sea Around Us" and "The Edge of the Sea" were best sellers in 1951 and 1955. Miss Carson, trained as a marine biologist, wrote gracefully of sea and shore life.

In her latest work, however, Miss Carson is not so gentle,



*Rachel Carson Stirs
Conflict—Producers
Are Crying 'Foul'*

fending the use of their products. Meetings have been held in Washington and New York. Statements are being drafted and counter-attacks plotted.

A drowsy midsummer has suddenly been enlivened by the greatest uproar in the pesticides industry since the cranberry scare of 1959.

Miss Carson's new book is entitled "Silent Spring." The title is derived from an idealized situation in which Miss Carson envisions an imaginary town where chemical pollution has silenced "the voices of spring."

Figure 9.4: Rachel Carson's book, *The Silent Spring*, was controversial, to say the least, but it focused public attention on problems of ecology.

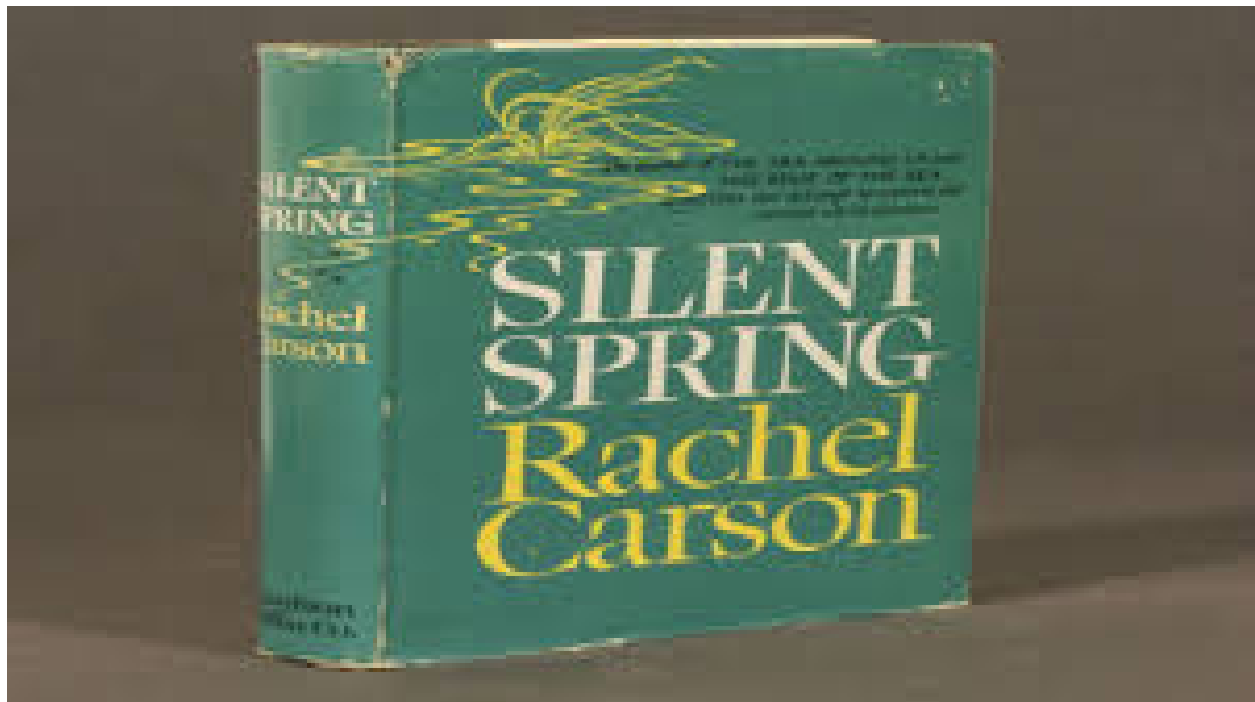

Figure 9.5: *The Silent Spring* was an international best-seller, and it ignited the environmental movement.

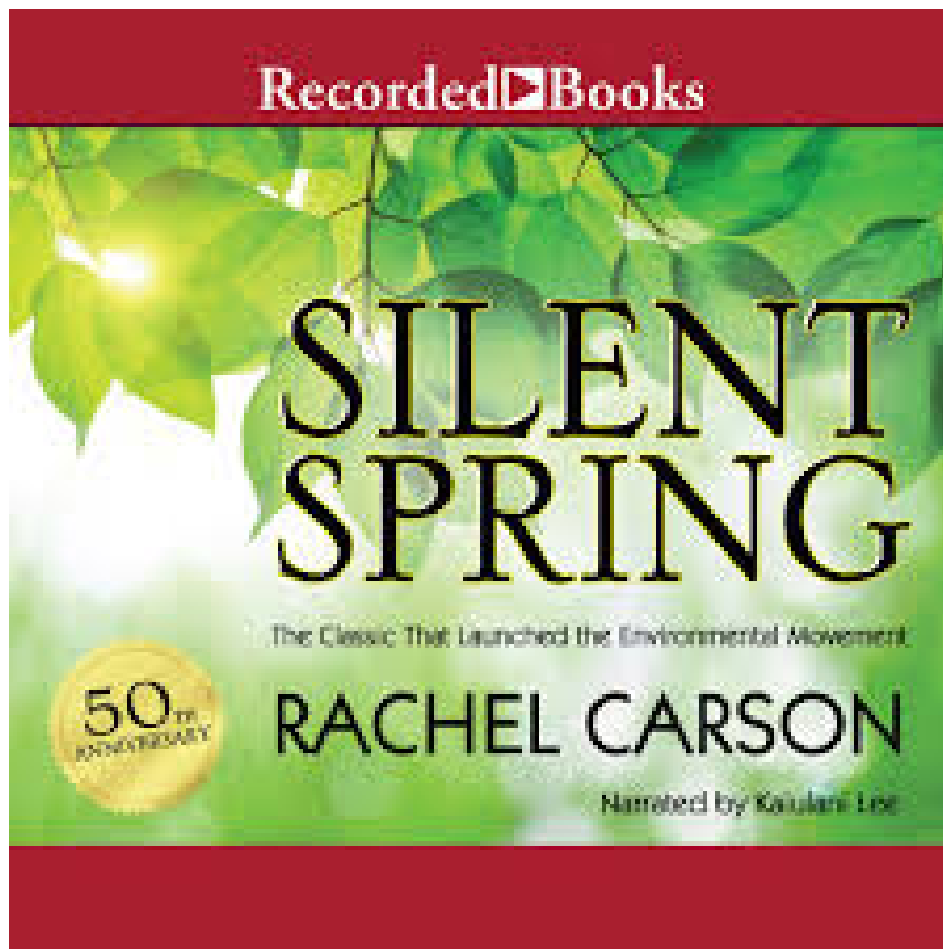

Figure 9.6: An audio version of *The Silent Spring*.



Figure 9.7: As Rachel Carson's influence increased, she began speaking to large audiences.



Figure 9.8: Statue of Carson at the Museo Rocsen, Nono, Argentina.

9.4 Biodiversity loss

According to Wikipedia's article on *Biodiversity Loss*,

“The current rate of global diversity loss is estimated to be 100 to 1000 times higher than the (naturally occurring) background extinction rate and expected to still grow in the upcoming years...

“According to the UN's Global Biodiversity Outlook 2014 estimates that 70 percent of the projected loss of terrestrial biodiversity are caused by agriculture use. Moreover, more than 1/3 of the planet's land surface is utilized for crops and grazing of livestock. Agriculture destroys biodiversity by converting natural habitats to intensely managed systems and by releasing pollutants, including greenhouses gases. Food value chains further amplify impacts including through energy use, transport and waste. The direct effects of urban growth on habitat loss are well understood: Building construction often results in habitat destruction and fragmentation. The rise of urbanization greatly reduced biodiversity when large areas of natural habitat are fragmented. Small habitat patches are unable to support the same level of genetic or taxonomic diversity as they formerly could while some of the more sensitive species may become locally extinct.

“Pollution from burning fossil fuels such as oil, coal and gas can remain in the air as particle pollutants or fall to the ground as acid rain. Acid rain, which is primarily composed of sulfuric and nitric acid, causes acidification of lakes, streams and sensitive forest soils, and contributes to slower forest growth and tree damage at high elevations. Moreover, Carbon dioxide released from burning fossil fuels and biomass, deforestation, and agricultural practices contributes to greenhouse gases, which prevent heat from escaping the earth's surface. With the increase in temperature expected from increasing greenhouse gases, there will be higher levels of air pollution, greater variability in weather patterns, and changes in the distribution of vegetation in the landscape. These two factors play a huge role towards biodiversity loss and entirely depended on human-driven factors.”

9.5 Illegal burning for palm oil plantations

According to a recent article published by the Union of Concerned Scientists, “One huge source of global warming emissions associated with palm oil is the draining and burning of the carbon-rich swamps known as peatlands. Peatlands can hold up to 18 to 28 times as much carbon as the forests above them; when they are drained and burned, both carbon and methane are released into the atmosphere - and unless the water table is restored, peatlands continue to decay and release global warming emissions for decades.

“As if that wasn't bad enough, the burning of peatlands releases a dangerous haze into

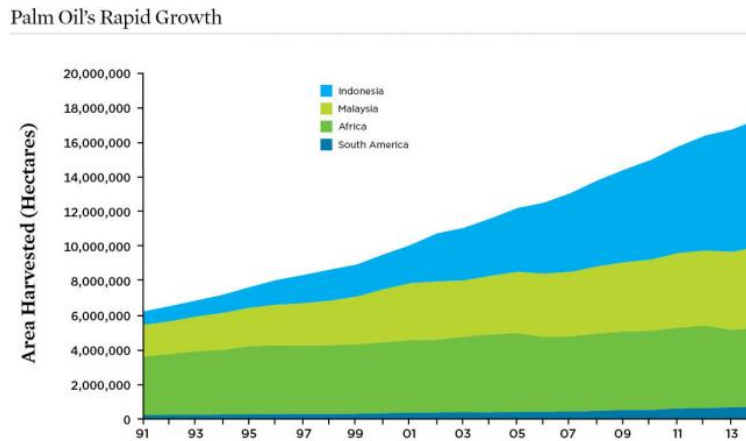

Figure 9.9: **The growth of palm oil cultivation between 1993 and 2013. The blue area at the top of the graph indicates the dramatic growth of palm oil production in Southeast Asia, especially Indonesia.**

the air, resulting in severe health impacts and significant economic losses. Each year, more than 100,000 deaths in Southeast Asia can be attributed to particulate matter exposure from landscape fires, many of which are peat fires.

“Beyond its global warming and human health impacts, palm oil production also takes a toll on biodiversity and human rights. Only about 15 percent of native animal species can survive the transition from primary forest to plantation. Among the species vulnerable to palm oil expansion are orangutans, tigers, rhinoceros, and elephants. Furthermore, palm oil growers have also been accused of using forced labor, seizing land from local populations, and other human rights abuses.”

Licences to burn forests for palm oil plantations are often granted by corrupt government officials. Fortunately, through the efforts of NGO’s the public has become increasingly aware of the problem, and supermarkets are being urged to purchase products containing deforestation-free palm oil.

Another recent article² states that “Indonesia is being deforested faster than any other country in the world, and it has everything to do with one product: palm oil.

“According to a new study in the journal *Nature Climate Change*, deforestation in the Southeast Asian archipelago is nearly double the rate in the Amazon. Indonesia is said to have lost 840,000 hectares (3,250 square miles) of forest in 2012 while Brazil - which has four times Indonesia’s rainforest - lost a still-massive 460,000 hectares.

“The report’s authors found that government figures underestimated the true toll of forest clearing by as much as half. In the last 12 years, it’s possible that the destruction of one million hectares of ‘primary forest’ went unreported.

“The tree-killing spree is largely due to slashing and burning vegetation for the expansion of palm oil plantations to feed growing demand in countries like China and India.

²<https://news.vice.com/article/indonesia-is-killing-the-planet-for-palm-oil>

Americans and Europeans are still far and away the top consumers per capita - it's estimated that palm oil can be found in roughly half the manufactured goods in any supermarket or drug store. Everything from peanut butter to soap to cosmetics contains the oil in its various forms.

"In Indonesia, where much of the land consists of carbon-rich soil known as peat, the problem is acute. Water-logged peat is commonly found in the jungles of Sumatra and Borneo, and merely exposing it to the air releases carbon dioxide into the atmosphere."

9.6 Jair Bolsonaro's attack on the Amazon rainforest

Beef is killing the rainforest

Beef Production is Killing the Amazon Rainforest. That is the title of an article published by onegreenplanet.org³. Here are some excerpts from the article

"The Amazon rainforest has been facing severe deforestation problems for several decades - it has lost about a fifth of its forest in the past three. While there are many causes, one of the main causes is cattle ranching, particularly in Brazil. Trees are cut and the land is converted into a pasture for cattle grazing. According to one report, an estimated 70 percent of deforestation in the Amazon basin can be attributed to cattle ranching. Using these numbers, cattle ranching in the Amazon has resulted in the loss of an area larger than the state of Washington.

"The government of Brazil offers loans of billions of dollars to support the expansion of its beef industry. Approximately 200 million pounds of beef is imported by the United States from Central America every year. While the chief importers of Brazilian beef were previously Europe and North America, nowadays Asian countries such as China and Russia consume more Brazilian beef than the European market. So, the demand is increasing day by day.

"With increasing population and increased per capita meat consumption, the rate of deforestation is increasing every day as well. It is expected that by 2018, the beef export will increase 93 percent, thereby increasing Brazil's beef market share of world exports to 61 percent. Beef is the most carbon-intensive form of meat production on the planet. The United Nations Food and Agriculture Organization finds that beef production gives rise to more greenhouse gases than the transportation industry."

Beef production and methane

A cow (or a bull) releases between 70 and 120 kg of methane per year. Methane is a greenhouse gas like carbon dioxide, but the negative effect on the climate of methane (CH₄) is 23 times higher than the effect of CO₂. Therefore the release of about 100 kg methane per year for each cow is equivalent to about 2,300 kg CO₂ per year.

³<http://www.onegreenplanet.org/animalsandnature/beef-production-is-killing-the-amazon-rainforest/>

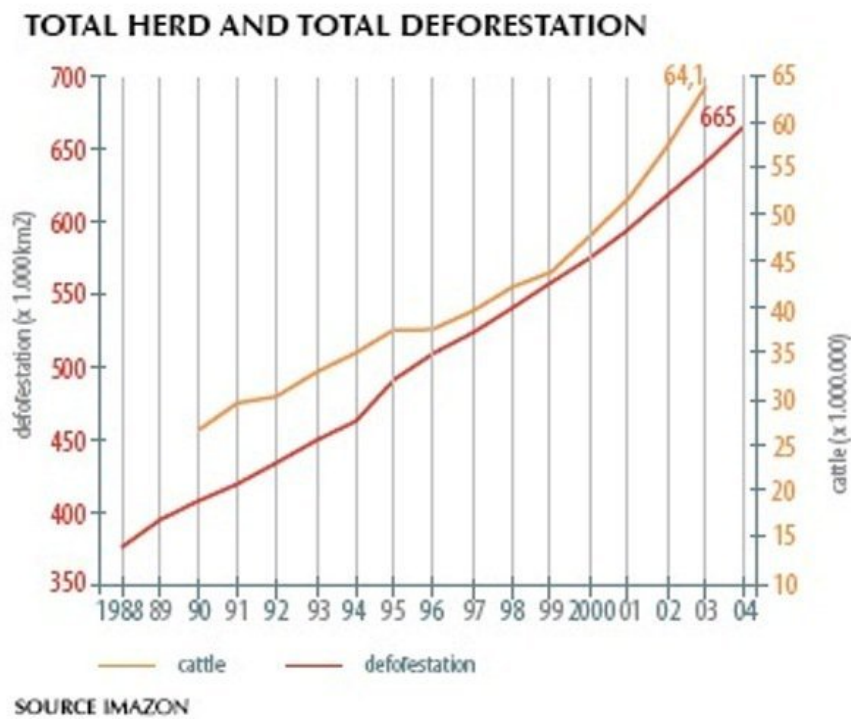

Figure 9.10: Total cattle herds and total deforestation in Amazonia between 1988 and 2104. Deforestation is measured in thousands of square kilometers, while herd size is measured in millions.

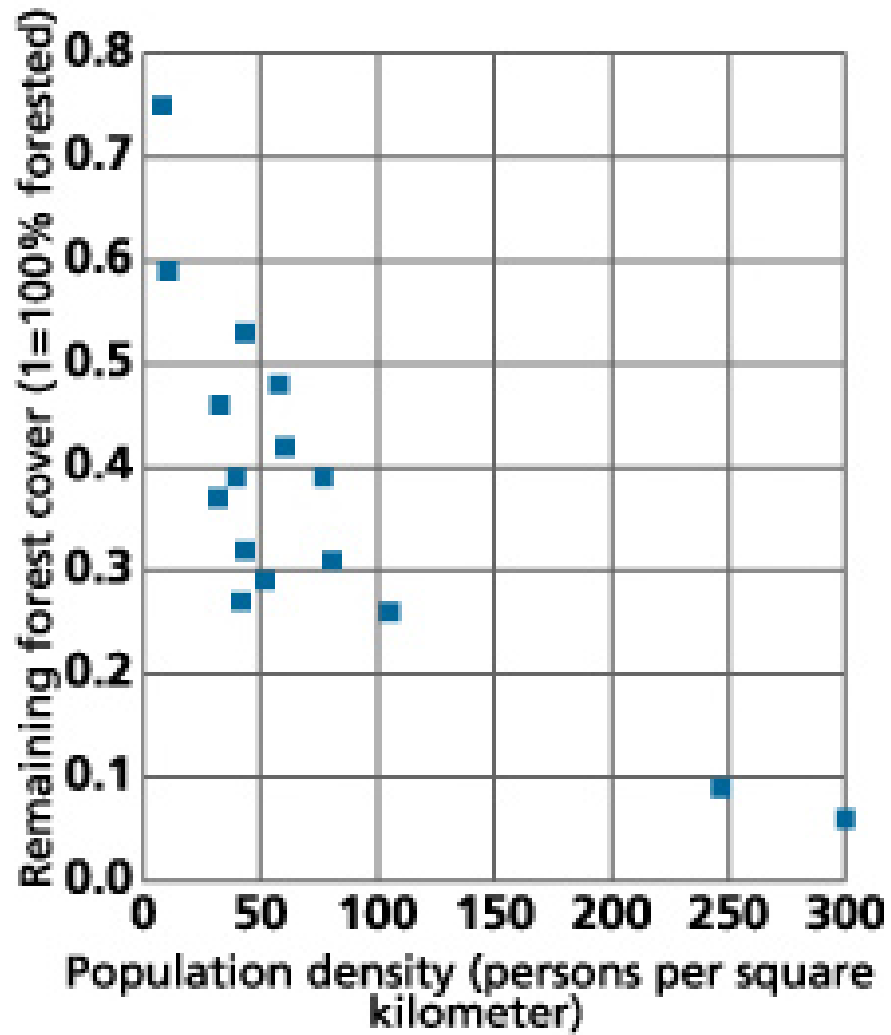

Figure 9.11: Population density and forest size.

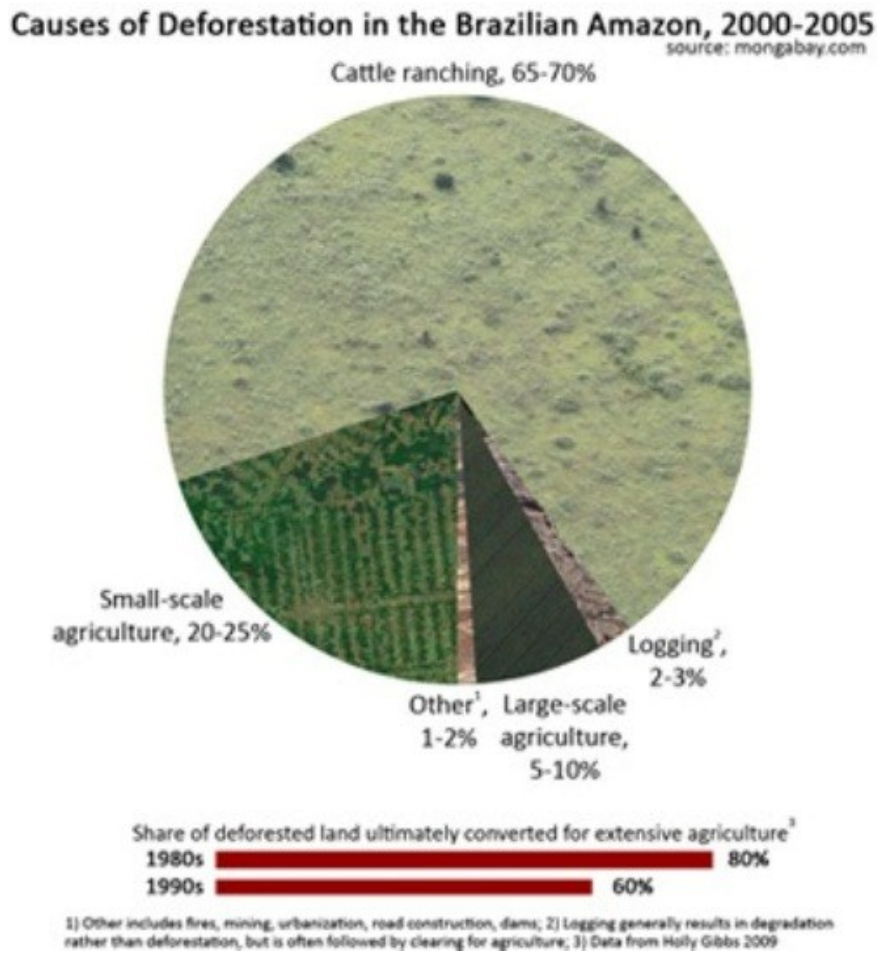

Figure 9.12: This figure shows the causes of Amazonian deforestation. The largest is beef production.

World-wide, there are about 1.5 billion cows and bulls. All ruminants (animals which regurgitates food and re-chews it) on the world emit about two billion metric tons of CO₂, equivalents per year. In addition, clearing of tropical forests and rain forests to get more grazing land and farm land is responsible for an extra 2.8 billion metric tons of CO₂ emission per year!

According to the Food and Agriculture Organization of the United Nations (FAO) agriculture is responsible for 18% of the total release of greenhouse gases world-wide (this is more than the whole transportation sector). Cattle-breeding is taking a major factor for these greenhouse gas emissions according to FAO. Says Henning Steinfeld, Chief of FAO's Livestock Information and Policy Branch and senior author of the report: "Livestock are one of the most significant contributors to today's most serious environmental problems. Urgent action is required to remedy the situation."

Livestock now use 30 percent of the earth's entire land surface, mostly permanent pasture but also including 33 percent of the global arable land used to producing feed for livestock, the report notes. As forests are cleared to create new pastures, it is a major driver of deforestation, especially in Latin America where, for example, some 70 percent of former forests in the Amazon have been turned over to grazing.

Dietary changes can help

You and I can help to save our common future by changing our diets, especially by cutting out beef. Not only does beef production produce methane and destroy rainforests, it also requires much more land per calorie than other forms of agriculture. By switching from beef to other protein-rich foods, we not only substantially reduce greenhouse gas emissions, but we also shorten the food chain, so that more grain will be available to feed the world's growing population. Furthermore a changed diet with less meat would improve our health, since animal fats have been linked with heart disease, circulatory problems and strokes.

9.7 Growing populations and forest loss

Deforestation is occurring at alarming rates, especially in countries that have high levels of population growth.⁴ The following table shows the forest loss in some countries where it is particularly high, together with their present and projected populations⁵. In the table, the annual rate of forest loss in the period 2000-2010. measured both in thousands of hectares and in percent. Populations in millions in 2010 are shown, together with projected populations in 2050.

⁴<http://www.prb.org/Publications/Articles/2004/PopulationGrowthandDeforestationACriticalandComplexRelationship.aspx>
⁵Population Action International, *Why Population Matters to Forests*

| country | forest loss | percent | pop. 2010 | pop. 2050 |
|-----------------|-------------|---------|-----------|-----------|
| Brazil | -2642 | -0.49 | 194.9 | 222.8 |
| Australia | -562 | -0.37 | 22.3 | 31.4 |
| Indonesia | -498 | -0.51 | 239.9 | 293.5 |
| Nigeria | -410 | -3.67 | 158.4 | 389.6 |
| Tanzania | -403 | -1.13 | 44.8 | 138.3 |
| Zimbabwe | -327 | -1.88 | 12.6 | 20.6 |
| Dem. Rep. Congo | .311 | -0.20 | 66.0 | 148.5 |
| Myanmar | -310 | -0.93 | 47.9 | 55.3 |
| Bolivia | -290 | -0.49 | 9.9 | 16.8 |
| Venezuela | -288 | -0.60 | 28.0 | 41.8 |

The main mechanism through which rapid population growth is linked to forest loss is felling forests for the sake of agriculture.

Notice that Nigeria is losing 3.67% of its forests each year. The population of Nigeria is projected to more than double by 2050, but rising death rates from heat, famine and conflicts may prevent this. In general, rising death rates from these causes may ultimately lead populations in the tropics to decrease rather than increase.

Population Action International points out that “Deforestation threatens the well-being and livelihoods of millions of people who heavily depend on forest resources. It is particularly devastating for women and children in poor rural communities.” The organization recommends that information and materials for family planning be made available to all through universal provision of primary health care.

9.8 Desertification and soil erosion

The Princeton University Dictionary defines *desertification* as “the process of fertile land transforming into desert typically as a result of deforestation, drought or improper/inappropriate agriculture”. It is estimated that approximately a billion people are under threat from further expansions of deserts.

Southward expansion of the Gobi desert

The Gobi desert is the fastest moving desert on earth. The rapid southward expansion of the Gobi is mainly due to human activities, such as overgrazing, deforestation and overuse of water. Dust storms from the Gobi desert are becoming more and more frequent. Sand dunes are reportedly forming only 70 km north of Beijing.

The Sahel

Another region in which the threat of desertification is extremely acute is the Sahel, which is the boundary between Africa's Sahara desert to the north and a region of savanna to the south. The Sahel stretches between the Atlantic Ocean and the Red Sea. During the last 50 years, the Sahel has lost approximately 650,000 km² of fertile land to the desert, and the boundary of the Sahara has moved 250 km southward.

The southward expansion of the Sahara has been caused partly by climate change, and partly by human activities. Growing human populations have put pressure on the fragile arid environment by overgrazing, tree-cutting for firewood and inappropriate agriculture.

9.9 Forest drying and wildfires: a feedback loop

When climate change produces aridity in a forested region, wildfires produced by lightning, stray sparks from falling stones, or human carelessness become increasingly likely. Forest fires contribute to global warming by releasing CO₂ into the atmosphere and by destroying climate-friendly tree-covered areas. Thus a dangerous feedback loop can be formed, and with every feedback loop there is an associated tipping point. In the case of forest drying and wildfires, passing the tipping point means that forest cover will be lost irrevocably. We must avoid passing wildfire tipping points through human activities, such as the deliberate burning of rainforests for the sake of oil palm plantations.

9.10 Degraded forests are carbon emitters

According to an article published in the journal *Science* on 28 September, 2017⁶, degraded tropical forest throughout the world have stopped being carbon absorbers, and are now carbon emitters.

Reporting on the study, *The Guardian*,⁷ noted that "Researchers found that forest areas in South America, Africa and Asia - which have until recently played a key role in absorbing greenhouse gases - are now releasing 425 teragrams of carbon annually, which is more than all the traffic in the United States.

"The study went further than any of its predecessors in measuring the impact of disturbance and degradation - the thinning of tree density and the culling of biodiversity below an apparently protected canopy - usually as a result of selective logging, fire, drought and hunting.

"Overall, more carbon was lost to degradation and disturbance than deforestation. The researchers stressed this was an opportunity as well as a concern because it was now possible

⁶A. Baccini et al., *Tropical forests are a net carbon source based on aboveground measurements of gain and loss*, DOI: 10.1126/science.aam5962

⁷<https://www.theguardian.com/environment/2017/sep/28/alarm-as-study-reveals-worlds-tropical-forests-are-huge-carbon-emission-source>

to identify which areas are being affected and to restore forests before they disappeared completely.”

9.11 Replanting forests

Around the world, people interested in replanting forests can take inspiration from the Green Belt Movement, which was founded in 1977 by Wangari Maathai.

The Green Belt Movement organizes women in rural Africa to combat deforestation by planting trees. In this way they restore their main source of fuel for cooking, generate income and stop soil erosion. Since its foundation in 1977, the movement has planted 51 million trees. Over 30,000 women have been trained in forestry, food processing, bee-keeping, and other trades. The movement emphasizes economic justice and empowerment of women. This work is particularly valuable in regions of water scarcity, because besides preventing soil erosion, forests prevent the rapid run-off of water.

In order to combat climate change and to prevent southward expansion of the Sahara, the African Union has initiated a project called the Great Green Wall. The project aims at creating a mosaic of green and productive landscapes stretching across Africa, the Sahel region to the Horn of Africa, a strip of forested land 15 km wide and 7,500 km long, stretching from Dakar to Djibouti.

In China, the Green Great Wall project aims at preventing the expansion of the Gobi desert by planting a 4,500-kilometer-long windbreaking line of forests. The project is expected to be completed by 2050.

Reforestation initiatives also exist in other countries, for example in India, Lebanon, Philippines, Japan, Germany, Canada and the United States.



Figure 9.13: Nobel Laureate Wangari Maathai (1940-2011).



Figure 9.14: Wangari Maathai speaks about deforestation.

9.12 Human ecology

By definition, “Human Ecology is the study of the interactions between man and nature in different cultures. Human Ecology combines the ideas and methods from several disciplines, including anthropology, sociology, biology, economic history and archeology.”

9.13 Paul R. Ehrlich and Anne H. Ehrlich

Education

Paul R. Ehrlich was born in 1932 in Philadelphia, Pennsylvania. He studied zoology at the University of Pennsylvania, and later received a Ph.D. from the University of Kansas, where he specialized in the study of insects. In 1959, Ehrlich joined the staff of Stanford University, where he was appointed to the Bing Professorship in Zoology in 1977.

Involvement in the population debate

In 1967, a lecture on population that Ehrlich gave at the Commonwealth Club of California was broadcast on the radio. Because of the publicity that followed the radio broadcast, Ehrlich was invited by the Sierra Club and Ballantine Books to write a book on the dangers of a human population explosion. Paul R. Ehrlich and his wife, Anne H. Ehrlich together wrote a book entitled *The Population Bomb*, which was published in 1968. Although the book was a joint husband and wife production, the publisher insisted that only Paul’s name should appear as author. Although others had written about the dangers of overpopulation, it was this book that brought the problem to a wide audience.

Books by Paul R. Ehrlich

- *How to Know the Butterflies* (1960)
- *Process of Evolution* (1963)
- *Butterflies and Plants: A Study in Coevolution* (1964)
- *The Population Bomb* (1968, revised 1971, updated 1978, re-issued 1988, 1998, 2008 and 2018)
- *Population, Resources, Environments: Issues in Human Ecology* (1970)
- *How to Be a Survivor* (1971)
- *Man and the Ecosphere: Readings from Scientific American* (1971)
- *Population, Resources, Environments: Issues in Human Ecology* Second Edition (1972)
- *Human Ecology: Problems and Solutions* (1973)
- *Introductory Biology* (1973)
- *The End of Affluence* (1975)
- *Biology and Society* (1976)

- *Ecoscience: Population, Resources, Environment* (1978)
- *The Race Bomb* (1978)
- *Extinction* (1981)
- *The Golden Door: International Migration, Mexico, and the United States* (1981)
- *The Cold and the Dark: The World after Nuclear War* (1984, with Carl Sagan, Donald Kennedy, and Walter Orr Roberts)
- *The Machinery of Nature: The Living World Around Us and How it Works* (1986)
- *Earth* (1987, co-authored with Anne Ehrlich)
- *Science of Ecology* (1987, with Joan Roughgarden)
- *The Cassandra Conference: Resources and the Human Predicament* (1988)
- *The Birder's Handbook: A field Guide to the Natural History of North American Birds* (1988, with David S. Dobkin and Darryl Wheye)
- *New World, New Mind: Moving Towards Conscious Evolution* (1988, co-authored with Robert E. Ornstein)
- *The Population Explosion* (1990, with Anne Ehrlich)
- *Healing the Planet: Strategies for Resolving the Environmental Crisis* (1991, co-authored with Anne Ehrlich)
- *Birds in Jeopardy: The Imperiled and Extinct Birds of the United States and Canada, Including Hawaii and Puerto Rico* (1992, with David S. Dobkin and Darryl Wheye)
- *The Stork and the Plow : The Equity Answer to the Human Dilemma* (1995, with Anne Ehrlich and Gretchen C. Daily)
- *A World of Wounds: Ecologists and the Human Dilemma* (1997)
- *Betrayal of Science and Reason: How Anti-Environment Rhetoric Threatens Our Future* (1998, with Anne Ehrlich)
- *Wild Solutions: How Biodiversity is Money in the Bank* (2001, with Andrew Beattie)
- *Human Natures: Genes, Cultures, and the Human Prospect* (2002)
- *One With Nineveh: Politics, Consumption, and the Human Future* (2004, with Anne Ehrlich)
- *On the Wings of Checkerspots: A Model System for Population Biology* (2004, edited volume, co-edited with Ilkka Hanski)
- *The Dominant Animal: Human Evolution and the Environment* (2008, with Anne Ehrlich)
- *Humanity on a Tightrope: Thoughts on Empathy, Family, and Big Changes for a Viable Future* (2010, with Robert E. Ornstein)
- *Conservation Biology for All* (2010, edited volume, co-edited with Navjot S. Sodhi)
- *Hope on Earth: A Conversation* (2014, co-authored with Michael Charles Tobias)
- *Killing the Koala and Poisoning the Prairie: Australia, America and the Environment* (2015, co-authored with Corey J. A. Bradshaw)
- *The Annihilation of Nature: Human Extinction of Birds and Mammals* (2015, with Anne Ehrlich and Gerardo Ceballos)



Figure 9.15: Paul R. Ehrlich in 1974.



Figure 9.16: Ehrlich speaking in 2008.



Figure 9.17: Anne H. Ehrlich, Paul Ehrlich's wife, is the co-author of many of his books. I know her personally because of the many Pugwash Conferences that we both have attended. I also know John P. Holdren for the same reason,

9.14 John P. Holdren

Education

John P. Holdren was born in Pennsylvania in 1944, but grew to in California. He graduated from MIT with a B.Sc. degree in 1965, and was awarded a Ph.D. by Stanford University in 1970, having studied aeronautics, astronautics and plasma physics.

Professor of environmental science

Holdren taught for 13 years at Harvard, and later for more than 20 years at the University of California, Berkeley. His research interests centered on environmental questions. These included global environmental change, population stabilization, energy technologies and policies, ways to reduce the dangers from nuclear weapons and materials, and science and technology policy.

Pugwash Conferences on Science and World Affairs

John P. Holdren served as the Chairman of the Executive Committee of Pugwash Conferences on Science and World Affairs. The Russell-Einstein Manifesto of 1955 called for a meeting of scientists from both sides of the Cold War to try to minimize the danger of a thermonuclear conflict. The first meeting took place at the summer home of the Canadian philanthropist Cyrus Eaton at the small village of Pugwash, Nova Scotia.

From this small beginning, a series of conferences developed, in which scientists, especially physicists, attempted to work for peace, and tried to address urgent global problems related to science, and especially to reduce the danger of a thermonuclear war. In 1995, Pugwash Conferences, and its president, Sir Joseph Rotblat, shared the Nobel Peace Prize. John P. Holdren delivered the acceptance speech on behalf of the organization.

Some books and articles by John P. Holdren

Holdren has authored over 200 articles and papers and has co-authored and co-edited some 20 books and book-length reports including

- *Ecoscience : Population, Resources, Environment* by John P. Holdren, Paul R. Ehrlich, Ann H. Ehrlich
- *Global Ecology* by John P. Holdren and Paul R. Ehrlich
- *The Cassandra Conference : Resources and the Human Predicament* by John P. Holdren and Paul R. Ehrlich
- *Strategic Defense and the Future of the Arms Race : A Pugwash Symposium* by John P. Holdren
- *Energy* by John P. Holdren
- *Science in the White House*. *Science*, May 2009, 567.[
- *Policy for Energy Technology Innovation. Acting in Time on Energy Policy*, (with Laura Diaz Anadon, Max H. Bazerman, David T. Ellwood, Kelly Sims Gallagher, William H. Hogan, Henry Lee, and Daniel Schrag), Brookings Institution Press, 2009.
- *The Future of Climate Change Policy: The U.S.'s Last Chance to Lead*. *Scientific American* 2008 Earth 3.0 Supplement. October 13, 2008, 20-21.
- *Convincing the Climate Change Skeptics*. *The Boston Globe*, August 4, 2008.[
- *Ending the Energy Stalemate: A Bipartisan Strategy To Meet America's Energy Challenges*. Presentation at the National Academies 2008 Energy Summit, Washington, D.C., March 14, 2008.
- *Global Climatic Disruption: Risks and Opportunities*. Presentation at Investor Summit on Climate Risk, New York, February 14, 2008.
- *Meeting the Climate-Change Challenge*. The John H. Chafee Memorial Lecture, National Council for Science and the Environment, Washington, D.C., January 17, 2008.



Figure 9.18: John P. Holdren held the position of Assistant to the President for Science and Technology between 2009 and 2017.



Figure 9.19: John P. Holdren with Barack Obama.



Figure 9.20: John P. Holdren: “Trump has no science policy to speak of”.

9.15 The earth is our mother

The World People's Conference on Climate Change and the Rights of Mother Earth

This conference took place in Tiquipaya, just outside the city of Cochabamba, Bolivia, from April 19-22, 2010. The event was attended by around 30,000 people from over 100 countries. It was hosted by the Bolivian government, and the proceedings were transmitted online by the organizations OneClimate and Global Campaign for Climate Action.

One of the outstanding results of the conference was the drafting of a Universal Declaration of the Rights of Mother Earth, modeled on the United Nations' Universal Declaration of Human Rights. Both Declarations might be criticized for being unrealistic,⁸ but both have great normative value. They define the goals towards which we ought to be striving.

Proposed Universal Declaration of the Rights of Mother Earth⁹

Preamble

We, the peoples and nations of Earth:

- *considering that we are all part of Mother Earth, an indivisible, living community of interrelated and interdependent beings with a common destiny;*
- *gratefully acknowledging that Mother Earth is the source of life, nourishment and learning and provides everything we need to live well;*
- *recognizing that the capitalist system and all forms of depredation, exploitation, abuse and contamination have caused great destruction, degradation and disruption of Mother Earth, putting life as we know it today at risk through phenomena such as climate change;*
- *convinced that in an interdependent living community it is not possible to recognize the rights of only human beings without causing an imbalance within Mother Earth;*
- *affirming that to guarantee human rights it is necessary to recognize and defend the rights of Mother Earth and all beings in her and that there are existing cultures, practices and laws that do so;*
- *conscious of the urgency of taking decisive, collective action to transform structures and systems that cause climate change and other threats to Mother Earth;*

⁸<https://www.transcend.org/tms/2012/12/human-rights-a-letter-to-santa-claus/>

⁹<https://www.theguardian.com/environment/2011/apr/10/bolivia-enshrines-natural-worlds-rights>
<https://pwccc.wordpress.com>

- *proclaim this Universal Declaration of the Rights of Mother Earth, and call on the General Assembly of the United Nation to adopt it, as a common standard of achievement for all peoples and all nations of the world, and to the end that every individual and institution takes responsibility for promoting through teaching, education, and consciousness raising, respect for the rights recognized in this Declaration and ensure through prompt and progressive measures and mechanisms, national and international, their universal and effective recognition and observance among all peoples and States in the world.*

Article 1: Mother Earth

1. *Mother Earth is a living being.*
2. *Mother Earth is a unique, indivisible, self-regulating community of interrelated beings that sustains, contains and reproduces all beings.*
3. *Each being is defined by its relationships as an integral part of Mother Earth.*
4. *The inherent rights of Mother Earth are inalienable in that they arise from the same source as existence.*
5. *Mother Earth and all beings are entitled to all the inherent rights recognized in this Declaration without distinction of any kind, such as may be made between organic and inorganic beings, species, origin, use to human beings, or any other status.*
6. *Just as human beings have human rights, all other beings also have rights which are specific to their species or kind and appropriate for their role and function within the communities within which they exist.*
7. *The rights of each being are limited by the rights of other beings and any conflict between their rights must be resolved in a way that maintains the integrity, balance and health of Mother Earth.*

Article 2. Inherent Rights of Mother Earth

1. *Mother Earth and all beings of which she is composed have the following inherent rights:*
 - (a) *the right to life and to exist;*
 - (b) *the right to be respected;*
 - (c) *the right to regenerate its bio-capacity and to continue its vital cycles and processes free from human disruptions;*
 - (d) *the right to maintain its identity and integrity as a distinct, self-regulating and interrelated being;*



Figure 9.21: **The earth is our mother.**

- (e) *the right to water as a source of life;*
 - (f) *the right to clean air;*
 - (g) *the right to integral health;*
 - (h) *the right to be free from contamination, pollution and toxic or radioactive waste;*
 - (i) *the right to not have its genetic structure modified or disrupted in a manner that threatens its integrity or vital and healthy functioning;*
 - (j) *the right to full and prompt restoration the violation of the rights recognized in this Declaration caused by human activities;*
2. *Each being has the right to a place and to play its role in Mother Earth for her harmonious functioning.*
 3. *Every being has the right to wellbeing and to live free from torture or cruel treatment by human beings.*

Article 3. Obligations of human beings to Mother Earth

1. *Every human being is responsible for respecting and living in harmony with Mother Earth.*

2. *Human beings, and all States guarantee peace and eliminate nuclear, chemical and biological weapons;*
 - (a) *act in accordance with the rights and obligations recognized in this Declaration;*
 - (b) *recognize and promote the full implementation and enforcement of the rights and obligations recognized in this Declaration;*
 - (c) *promote and participate in learning, analysis, interpretation and communication about how to live in harmony with Mother Earth in accordance with this Declaration;*
 - (d) *ensure that the pursuit of human wellbeing contributes to the wellbeing of Mother Earth, now and in the future;*
 - (e) *establish and apply effective norms and laws for the defense, protection and conservation of the rights of Mother Earth;*
 - (f) *respect, protect, conserve and where necessary, restore the integrity, of the vital ecological cycles, processes and balances of Mother Earth;*
 - (g) *guarantee that the damages caused by human violations of the inherent rights recognized in this Declaration are rectified and that those responsible are held accountable for restoring the integrity and health of Mother Earth;*
 - (h) *empower human beings and institutions to defend the rights of Mother Earth and of all beings;*
 - (i) *establish precautionary and restrictive measures to prevent human activities from causing species extinction, the destruction of ecosystems or the disruption of ecological cycles;*
 - (j) *guarantee peace and eliminate nuclear, chemical and biological weapons;*
 - (k) *promote and support practices of respect for Mother Earth and all beings, in accordance with their own cultures, traditions and customs;*
 - (l) *promote economic systems that are in harmony with Mother Earth and in accordance with the rights recognized in this Declaration.*

Article 4: Definitions

1. *The term “being” includes ecosystems, natural communities, species and all other natural entities which exist as part of Mother Earth.*
2. *Nothing in this Declaration restricts the recognition of other inherent rights of all beings or specified beings.*



Figure 9.22: Love and respect Mother Earth.



Figure 9.23: We need reverence for all life, and even reverence for inanimate nature. We need respect and love for Mother Earth. She will return out love.

Suggestions for further reading

1. Rachel L. Carson *Under the Sea-Wind* Oxford University Press, 1952
2. Rachel L. Carson *The Sea Around Us* Oxford University Press, 1953
3. Rachel Carson *The Edge of the Sea* Houghton Mifflin, 1955
4. Rachel Carson *Silent Spring* Houghton Mifflin, 1962
5. Linda Lear *Rachel Carson: The Life of the Author of Silent Spring* Penguin Group, 1997
6. William Souder *On a Farther Shore: The Life and Legacy of Rachel Carson* Crown Publishers, 2012
7. C.H. Wood and David L. Skole, *Linking satellite, census, and survey data to study deforestation in the Brazilian Amazon*, in **People and Pixels**, ed. D. Liverman et al. (Washington, DC: National Academies Press, 1998).
8. Suzi Kerr, Alexander S. Pfaff, and Arturo Sanchez, *Development and Deforestation: Evidence From Costa Rica* (unpublished paper, 2003).
9. Frederick A.B. Meyerson, *Population, Biodiversity and Changing Climate*, *Advances in Applied Biodiversity Science* **4** (2003), Chapter 11 (2003): 83-90
10. Andrew D. Foster and Mark R. Rosenzweig, *Economic Growth and the Rise of Forests*,” *The Quarterly Journal of Economics* (May 2003): 601-637.
11. A. Balmford et al., *Conservation Conflicts Across Africa*, *Science* **291** (2001): 2616-19.
12. Richard P. Cincotta, Jennifer Wisniewski, and Robert Engelman, *Human Population in the Biodiversity Hotspots*, *Nature* **404** (2000): 990-92.
13. Food and Agriculture Organization of the United Nations (FAO). 2010. *Global Forest Resources Assessment 2010*. Rome: FAO.
14. World Bank. 2004. *Sustaining Forests: A Development Strategy*. Washington DC: World Bank.
15. Food and Agriculture Organization of the United Nations (FAO). 2006. *Global Forest Resources Assessment 2005: Progress Towards Sustainable Forest Management*. Rome: FAO.
16. United Nations Population Division. 2009. *World Population Prospects: The 2008 Revision*. New York: UN Population Division.
17. Pan, W, D Carr, A Barbierri, R Bilsborrow and C Suchindran. 2007. *Forest Clearing in the Ecuadorian Amazon: A Study of Patterns Over Space and Time*. *Population Research and Policy Review* **26**:635-659.
18. Geist, H J and E F Lambin. 2002. *Proximate Causes and Underlying Driving Forces of Tropical Deforestation*. *Bioscience* **52(2)**: 143-150.
19. Rosero-Bixby, L and A Palloni. 1996. *Population and Deforestation in Costa Rica*. CDE Working Paper No. 96-19. Madison: 1996.
20. Carr, D, L Sutter and A Barbieri. 2006. *Population Dynamics and Tropical Deforestation: State of the Debate and Conceptual Challenges*. *Population and Environment* **27**:89-113.

21. Barreto, P, C Souza, R Nogueron, A Anderson, R Salamao and J Wiles. 2006. *Human Pressure on the Brazilian Amazon Forests*. Washington DC: World Resources Institute (WRI).
22. Ramankutty, N, JA Foley and NJ Olejniczak. 2002. *People on the Land: Changes in Global Population and Croplands during the 20th Century*. *Ambio* **31(3)**: 251-257.
23. Food and Agriculture Organization of the United Nations (FAO). 2008. *Forests and Energy: Key Issues*. Rome: FAO.
24. P. Dasgupta, *Population, Resources and Poverty*, *Ambio*, **21**, 95-101, (1992).
25. L.R. Brown, *Who Will Feed China?*, W.W. Norton, New York, (1995).
26. L.R. Brown, et al., *Saving the Planet. How to Shape and Environmentally Sustainable Global Economy*, W.W. Norton, New York, (1991).
27. L.R. Brown, *Postmodern Malthus: Are There Too Many of Us to Survive?*, *The Washington Post*, July 18, (1993).
28. L.R. Brown and H. Kane, *Full House. Reassessing the Earth's Population Carrying Capacity*, W.W. Norton, New York, (1991).
29. L.R. Brown, *Seeds of Change*, Praeger Publishers, New York, (1970).
30. L.R. Brown, *The Worldwide Loss of Cropland*, Worldwatch Paper 24, Worldwatch Institute, Washington, D.C., (1978).
31. L.R. Brown, and J.L. Jacobson, *Our Demographically Divided World*, Worldwatch Paper 74, Worldwatch Institute, Washington D.C., (1986).
32. L.R. Brown, and J.L. Jacobson, *The Future of Urbanization: Facing the Ecological and Economic Constraints*, Worldwatch Paper 77, Worldwatch Institute, Washington D.C., (1987).
33. L.R. Brown, and others, *State of the World*, W.W. Norton, New York, (published annually).
34. H. Brown, *The Human Future Revisited. The World Predicament and Possible Solutions*, W.W. Norton, New York, (1978).
35. H. Hanson, N.E. Borlaug and N.E. Anderson, *Wheat in the Third World*, Westview Press, Boulder, Colorado, (1982).
36. A. Dil, ed., *Norman Borlaug and World Hunger*, Bookservice International, San Diego/Islamabad/Lahore, (1997).
37. N.E. Borlaug, *The Green Revolution Revisited and the Road Ahead*, Norwegian Nobel Institute, Oslo, Norway, (2000).
38. N.E. Borlaug, *Ending World Hunger. The Promise of Biotechnology and the Threat of Antiscience Zealotry*, *Plant Physiology*, **124**, 487-490, (2000).
39. M. Giampietro and D. Pimental, *The Tightening Conflict: Population, Energy Use and the Ecology of Agriculture*, in *Negative Population Forum*, L. Grant ed., Negative Population Growth, Inc., Teaneck, N.J., (1993).
40. H.W. Kendall and D. Pimental, *Constraints on the Expansion of the Global Food Supply*, *Ambio*, **23**, 198-2005, (1994).
41. D. Pimental et al., *Natural Resources and Optimum Human Population*, *Population and Environment*, **15**, 347-369, (1994).

42. D. Pimental et al., *Environmental and Economic Costs of Soil Erosion and Conservation Benefits*, Science, **267**, 1117-1123, (1995).
43. D. Pimental et al., *Natural Resources and Optimum Human Population*, Population and Environment, **15**, 347-369, (1994).
44. D. Pimental and M. Pimental, *Food Energy and Society*, University Press of Colorado, Niwot, Colorado, (1996).
45. D. Pimental et al., *Environmental and Economic Costs of Soil Erosion and Conservation Benefits*, Science, **267**, 1117-1123, (1995).
46. RS and NAS, *The Royal Society and the National Academy of Sciences on Population Growth and Sustainability*, Population and Development Review, **18**, 375-378, (1992).
47. A.M. Altieri, *Agroecology: The Science of Sustainable Agriculture*, Westview Press, Boulder, Colorado, (1995).
48. G. Conway, *The Doubly Green Revolution*, Cornell University Press, (1997).
49. J. Dreze and A. Sen, *Hunger and Public Action*, Oxford University Press, (1991).
50. G. Bridger, and M. de Soissons, *Famine in Retreat?*, Dent, London, (1970).
51. W. Brandt, *World Armament and World Hunger: A Call for Action*, Victor Gollanz Ltd., London, (1982).
52. A.K.M.A. Chowdhury and L.C. Chen, *The Dynamics of Contemporary Famine*, Ford Foundation, Dacca, Pakistan, (1977)
53. J. Shepard, *The Politics of Starvation*, Carnegie Endowment for International Peace, Washington D.C., (1975).
54. M.E. Clark, *Ariadne's Thread: The Search for New Modes of Thinking*, St. Martin's Press, New York, (1989).
55. J.-C. Chesnais, *The Demographic Transition*, Oxford, (1992).
56. C.M. Cipola, *The Economic History of World Population*, Penguin Books Ltd., (1974).
57. E. Draper, *Birth Control in the Modern World*, Penguin Books, Ltd., (1972).
58. Draper Fund Report No. 15, *Towards Smaller Families: The Crucial Role of the Private Sector*, Population Crisis Committee, 1120 Nineteenth Street, N.W., Washington D.C. 20036, (1986).
59. E. Eckholm, *Losing Ground: Environmental Stress and World Food Prospects*, W.W. Norton, New York, (1975).
60. E. Havemann, *Birth Control*, Time-Life Books, (1967).
61. J. Jacobsen, *Promoting Population Stabilization: Incentives for Small Families*, Worldwatch Paper 54, Worldwatch Institute, Washington D.C., (1983).
62. N. Keyfitz, *Applied Mathematical Demography*, Wiley, New York, (1977).
63. W. Latz (ed.), *Future Demographic Trends*, Academic Press, New York, (1979).
64. World Bank, *Poverty and Hunger: Issues and Options for Food Security in Developing Countries*, Washington D.C., (1986).
65. J.E. Cohen, *How Many People Can the Earth Support?*, W.W. Norton, New York, (1995).
66. J. Amos, *Climate Food Crisis to Deepen*, BBC News (5 September, 2005).

67. J. Vidal and T. Ratford, *One in Six Countries Facing Food Shortage*, The Guardian, (30 June, 2005).
68. J. Mann, *Biting the Environment that Feeds Us*, The Washington Post, July 29, 1994.
69. G.R. Lucas, Jr., and T.W. Ogletree, (editors), *Lifeboat Ethics. The Moral Dilemmas of World Hunger*, Harper and Row, New York.
70. J.L. Jacobson, *Gender Bias: Roadblock to Sustainable Development*, Worldwatch Paper 110, Worldwatch Institute, Washington D.C., (1992).
71. J. Gever, R. Kaufmann, D. Skole and C. Vorosmarty, *Beyond Oil: The Threat to Food and Fuel in the Coming Decades*, Ballinger, Cambridge MA, (1986).
72. M. ul Haq, *The Poverty Curtain: Choices for the Third World*, Columbia University Pres, New York, (1976).
73. H. Le Bras, *La Planète au Village*, Datar, Paris, (1993).
74. E. Mayr, *Population, Species and Evolution*, Harvard University Press, Cambridge, (1970).
75. D.C. Pirages and P.R. Ehrlich, *Ark II: Social Responses to Environmental Imperatives*, W.H. Freeman, San Francisco, (1974).
76. Population Reference Bureau, *World Population Data Sheet*, PRM, 777 Fourteenth Street NW, Washington D.C. 20007, (published annually).
77. R. Pressat, *Population*, Penguin Books Ltd., (1970).
78. M. Rechigl (ed.), *Man/Food Equation*, Academic Press, New York, (1975).
79. J.C. Ryan, *Life Support: Conserving Biological Diversity*, Worldwatch Paper 108, Worldwatch Institute, Washington D.C., (1992).
80. J. Shepard, *The Politics of Starvation*, Carnegie Endowment for International Peace, Washington D.C., (1975).
81. P.B. Smith, J.D. Schilling and A.P. Haines, *Introduction and Summary*, in *Draft Report of the Pugwash Study Group: The World at the Crossroads*, Berlin, (1992).
82. B. Stokes, *Local Responses to Global Problems: A Key to Meeting Basic Human Needs*, Worldwatch Paper 17, Worldwatch Institute, Washington D.C., (1978).
83. L. Timberlake, *Only One Earth: Living for the Future*, BBC/ Earthscan, London, (1987).
84. UNEP, *Environmental Data Report*, Blackwell, Oxford, (published annually).
85. UNESCO, *International Coordinating Council of Man and the Biosphere*, MAB Report Series No. 58, Paris, (1985).
86. United Nations Fund for Population Activities, *A Bibliography of United Nations Publications on Population*, United Nations, New York, (1977).
87. United Nations Fund for Population Activities, *The State of World Population*, UNPF, 220 East 42nd Street, New York, 10017, (published annually).
88. United Nations Secretariat, *World Population Prospects Beyond the Year 2000*, U.N., New York, (1973).
89. J. van Klinken, *Het Dierde Punte*, Uitgiversmaatschappij J.H. Kok-Kampen, Netherlands (1989).
90. P.M. Vitousek, P.R. Ehrlich, A.H. Ehrlich and P.A. Matson, *Human Appropriation of the Products of Photosynthesis*, *Bioscience*, 34, 368-373, (1986).

91. B. Ward and R. Dubos, *Only One Earth*, Penguin Books Ltd., (1973).
92. WHO/UNFPA/UNICEF, *The Reproductive Health of Adolescents: A Strategy for Action*, World Health Organization, Geneva, (1989).
93. E.O. Wilson, *Sociobiology*, Harvard University Press, (1975).
94. E.O. Wilson (ed.), *Biodiversity*, National Academy Press, Washington D.C., (1988).
95. E.O. Wilson, *The Diversity of Life*, Allen Lane, The Penguin Press, London, (1992).
96. G. Woodwell (ed.), *The Earth in Transition: Patterns and Processes of Biotic Impoverishment*, Cambridge University Press, (1990).
97. World Commission on Environment and Development, *Our Common Future*, Oxford University Press, (1987).
98. World Bank, *Poverty and Hunger: Issues and Options for Food Security in Developing Countries*, Washington D.C., (1986).
99. World Resources Institute (WRI), *Global Biodiversity Strategy*, The World Conservation Union (IUCN), United Nations Environment Programme (UNEP), (1992).
100. World Resources Institute, *World Resources*, Oxford University Press, New York, (published annually).
101. J.E. Cohen, *How Many People Can the Earth Support?*, W.W. Norton, New York, (1995).
102. D.W. Pearce and R.K. Turner, *Economics of Natural Resources and the Environment*, Johns Hopkins University Press, Baltimore, (1990).
103. P. Bartelmus, *Environment, Growth and Development: The Concepts and Strategies of Sustainability*, Routledge, New York, (1994).
104. D. Pimental et al., *Natural Resources and Optimum Human Population*, Population and Environment, **15**, 347-369, (1994).
105. D. Pimentel and M. Pimentel, *Food Energy and Society*, University Press of Colorado, Niwot, Colorado, (1996).
106. H. Brown, *The Human Future Revisited. The World Predicament and Possible Solutions*, W.W. Norton, New York, (1978).
107. W. Jackson, *Man and the Environment*, Wm. C. Brown, Dubuque, Iowa, (1971).
108. Food and Agriculture Organization (FAO), *The Global Forest Assessment 2000* (Rome: Food and Agriculture Organization, Committee on Forestry, 2000).
109. Thomas K. Rudel, Kevin Flesher, Diana Bates, Sandra Baptista, and Peter Holmgren, *Tropical Deforestation Literature: Geographical and Historical Patterns*, *Unasylva* **203**, Vol. 51 (2000): 11-18;
110. Alexander S. Pfaff, *What drives deforestation in the Brazilian Amazon?* *Journal of Economics and Management* **37** (1999): 26-43.
111. Phillip M. Fearnside, *Human Carrying Capacity Estimation in Brazilian Amazonia as the Basis for Sustainable Development*, *Environmental Conservation* **24** (1997): 271-82;
112. Frederick A.B. Meyerson, *Human Population Density, Deforestation and Protected Areas Management: A Multi-scale Analysis of Central America, Guatemala,*

113. The Maya Biosphere Reserve, *Proceedings of the International Union for the Scientific Study of Population*, XXIV General Population Conference (Salvador, Brazil, 2001).
114. Millenium Ecosystem Assessment. 2005. *Ecosystems and Human Well-Being Biodiversity Synthesis*. Washington DC: World Resources Institute (WRI).
115. Sherbinin, A, D Carr, S Cassels and L Jiang. 2007. *Population and Environment*. The Annual Review of Environment and Resources **32**: 345-373.
116. Leahy, E, R Englelman, C Vogel, S Haddock and T Preston. 2007. *The Shape of Things to Come*. Washington, DC: PAI.
117. DeFries, R, T K Rudel, M Uriarte and M Hansen. 2010. *Deforestation Driven by Urban Population Growth and Agricultural Trade in the Twenty-First Century*. Nature Geoscience **3**: 178-181.
118. Lambin, E F and P Meyfroidt. 2011. *Global Land Use Change, Economic Globalization, and the Looming Land Scarcity*. Proceedings of the National Academy of Sciences **108**: 3465-3472.
119. United Nations Population Division. 2010. *World Urbanization Prospects: The 2009 Revision*. New York: UN Population Division.
120. David Wasdell, *Arctic Dynamics*,
<http://www.envisionation.co.uk/index.php/videos/arctic-dynamics>
121. Wikipedia, *Climate change in the Arctic*,
122. World Bank, *Climate Change Report Warns of Dramatically Warmer World This Century*,
<http://www.worldbank.org/en/news/feature/2012/11/18/Climate-change-report-warns-dramatically-warmer-world-this-century>
123. Wikipedia, *Retreat of glaciers since 1850*,
124. Natural Resources Defense Council, *Climate Change, Water, and Risk: Current water demands are not sustainable*, <http://www.nrdc.org/globalwarming/watersustainability/files/Wat>
125. Wikipedia, *2011 East Africa drought*,
126. OXFAM *Working for the Few: Political capture and economic inequality*, <http://www.oxfam.org/en/rfew>
127. Winnie Byanyima, *Inequality Is Not Inevitable: It's Time to Even It Up!*, Common Dreams <http://www.commondreams.org/views/2014/10/30/inequality-not-inevitable-its-time-even-it>
128. Abarbanel A, McClusky T (1950) *Is the world getting warmer?* Saturday Evening Post, 1 Jul, p22
129. Bagdikian BH (2004) *The New Media Monopoly*. Boston, MA, USA: Beacon
130. Bennett WL (2002) *News: The Politics of Illusion, 5th edition*. New York, NY, USA: Longman
131. Boykoff MT, Boykoff JM (2004) *Balance as bias: global warming and the US prestige press*. Glob Environ Change **14**: 125-136
132. Boykoff MT, Boykoff JM (2007) *Climate change and journalistic norms: A case study of U.S. mass-media coverage*. Geoforum (in press)

133. Carey JW (1989) *Communication as Culture: Essays on Media and Society*. Boston, MA, USA: Unwin Hyman
134. Carvalho A (2005) *Representing the politics of the greenhouse effect: Discursive strategies in the British media*. *Critical Discourse Studies* **2**: 1-29
135. CEI (2006) *We Call it Life*. Washington, DC, USA: Competitive Enterprise Institute
136. Cowen RC (1957) *Are men changing the earth's weather?* *Christian Science Monitor*, 4 Dec, p13
137. Cushman JH (1998) *Industrial group plans to battle climate treaty*. *New York Times*, 26 Apr, p1
138. Doyle G (2002) *Media Ownership: The Economics and Politics of Convergence and Concentration in the UK and European Media*. London, UK: Sage Publications
139. Dunwoody S, Peters HP (1992) *Mass media coverage of technological and environmental risks: A survey of research in the United States and Germany*. *Public Underst Sci* **1**: 199-230
140. Entman RM (1993) *Framing: toward clarification of a fractured paradigm*. *J Commun* **43**: 51-58
141. Fleming JR (1998) *Historical Perspectives on Climate Change*. Oxford, UK: Oxford University Press
142. Gelbspan R (1998) *The Heat Is On*. Cambridge, MA, USA: Perseus Books
143. Grove RH (2003) *Green Imperialism*. Cambridge, UK: Cambridge University Press
144. Leggett J (2001) *The Carbon War*. New York, NY, USA: Routledge
145. McChesney RW (1999) *Rich Media, Poor Democracy: Communication Politics in Dubious Times*. Urbana, IL, USA: University of Illinois Press
146. McComas K, Shanahan J (1999) *Telling stories about global climate change: Measuring the impact of narratives on issue cycles*. *Communic Res* **26**: 30-57
147. McCright AM (2007) *Dealing with climate change contrarians*. In Moser SC, Dilling L (eds) *Creating a Climate for Change: Communicating Climate Change and Facilitating Social Change*, pp 200-212. Cambridge, UK: Cambridge University Press
148. McCright AM, Dunlap RE (2000) *Challenging global warming as a social problem: An analysis of the conservative movement's counter-claims*. *Soc Probl* **47**: 499-522
149. McCright AM, Dunlap RE (2003) *Defeating Kyoto: The conservative movement's impact on U.S. climate change policy*. *Soc Probl* **50**: 348-373
150. Mooney C (2004) *Blinded by science*. *Columbia Journalism Review* 6(Nov/Dec), www.cjr.org
151. NSF (2004) *Science and Engineering Indicators 2004*. Washington, DC, USA: National Science Foundation Project for Excellence in Journalism (2006) *The State of the News Media 2006*. Washington, DC, USA:
152. Project for Excellence in Journalism. www.stateofthenewsmedia.org Rajan SR (2006) *Modernizing Nature*. Oxford, UK: Oxford University Press
153. Sandell C, Blakemore B (2006) *ABC News reporting cited as evidence in congressional hearing on global warming*. *ABC News*, 27 Jul, <http://abcnews.go.com>
154. Shabecoff P (1988) *Global warming has begun, expert tells senate*. *New York Times*, 24 Jun, pA1

155. Shrader-Frechette KS (1993) *Burying Uncertainty*. Berkeley, CA, USA: University of California Press
156. Starr P (2004) *The Creation of the Media: Political Origins of Modern Communications*. New York, NY, USA: Basic Books
157. Ungar S (1992) *The rise and (relative) decline of global warming as a social problem*. *Sociol Q* **33**: 483-501
158. Weart SR (2003) *The Discovery of Global Warming*. Cambridge, MA, USA: Harvard University Press
159. Weingart P, Engels A, Pansegrau P (2000) *Risks of communication: Discourses on climate change in science, politics, and the mass media*. *Public Underst Sci* **9**: 261-283
160. Wilkins L (1993) *Between the facts and values: Print media coverage of the greenhouse effect, 1987-1990*. *Public Underst Sci* **2**: 71-84
161. Wilson KM (1995) *Mass media as sources of global warming knowledge*. *Mass Communication Review* **22**: 75-89
162. Wilson KM (2000) *Communicating climate change through the media: Predictions, politics, and perceptions of risks*. In Allan S, Adam B, Carter C (eds) *Environmental Risks and the Media*, pp 201-217. New York, NY, USA: Routledge
163. Zehr SC (2000) *Public representations of scientific uncertainty about global climate change*. *Public Underst Sci* **9**: 85-103
164. O.N. Larsen, ed., *Violence and the Mass Media*, Harper and Row, (1968).
165. R.M. Liebert et al., *The Early Window: The Effects of Television on Children and Youth*, Pergamon, Elmsford, NY, (1982).
166. G. Noble, *Children in Front of the Small Screen*, Constable, London, (1975).
167. H.J. Schneider, *Das Geschäft mit dem Verbrechen. Massenmedien und Kriminalität*, Kindler, Munich, (1980).
168. W. Schramm, ed., *Grundfragen der Kommunikationsforschung*, Munich, (1973).
169. J.L. Singer and D.G. Singer, *Television, Imagination and Aggression: A Study of Preschoolers*, Erlbaum, Hillsdale, NY, (1981).
170. O.N. Larsen, ed., *Violence and the Mass Media*, Harper and Row, (1968).
171. H.J. Skornia, *Television and Society*, McGraw-Hill, New York, (1965).
172. D.L. Bridgeman, ed., *The Nature of Prosocial Behavior*, New York, Academic Press, (1983).
173. N. Eisenberg, ed., *The Development of Prosocial Behavior*, New York, Academic Press, (1982).
174. W.H. Goodenough, *Cooperation and Change: An Anthropological Approach to Community Development*, New York, Russell Sage Foundation, (1963).
175. J.R. Macauley and L. Berkowitz, *Altruism and Helping Behavior*, Academic Press, New York, (1970).
176. P. Mussen and N. Eisenberg, *Roots of Caring, Sharing and Helping*, Freeman, San Francisco, (1977).
177. J.P. Rushton and R.M. Sorrentino, eds., *Altruism and Helping Behavior*, Erlbaum, Hillsdale, NJ, (1981).

178. L. Wispé, ed, *Altruism, Sympathy and Helping*, Academic Press, New York, (1978).
179. J.-C. Guedon, *La Planète Cyber, Internet et Cyberspace*, Gallimard, (1996).
180. J. Segal, *Théorie de l'information: sciences, techniques et société, de la seconde guerre mondiale ' l'aube du XXI siècle*, Thèse de Doctorat, Université Lumière Lyon II, (1998), (<http://www.mpiwg-berlin.mpg.de/staff/segal/thesis/>)
181. H. von Foerster, editor, *Cybernetics - circular, causal and feed-back mechanisms in biological and social systems*. Transactions of sixth- tenth conferences, Josiah J. Macy Jr. Foundation, New York, (1950- 1954).
182. G. Bateson, *Communication, the Social Matrix of Psychiatry*, Norton, (1951).
183. G. Bateson, *Steps to an Ecology of Mind*, Chandler, San Francisco, (1972).
184. G. Bateson, *Communication et Société*, Seuil, Paris, (1988).
185. R.M.. Liebert et al., *The Early Window: The Effects of Television on Children and Youth*, Pergamon, Elmsford, NY, (1982).
186. G. Noble, *Children in Front of the Small Screen*, Constable, London, (1975).
187. W. Schramm, ed., *Grundfragen der Kommunikationsforschung*, Munich, (1973).
188. J.L. Singer and D.G. Singer, *Television, Imagination and Aggression: A Study of Preschoolers*, Erlbaum, Hillsdale, NY, (1981).
189. P. Dasgupta, *Population, Resources and Poverty*, *Ambio*, **21**, 95-101, (1992).
190. L.R. Brown, *Who Will Feed China?*, W.W. Norton, New York, (1995).
191. L.R. Brown, et al., *Saving the Planet. How to Shape and Environmentally Sustainable Global Economy*, W.W. Norton, New York, (1991).
192. L.R. Brown, *Postmodern Malthus: Are There Too Many of Us to Survive?*, *The Washington Post*, July 18, (1993).
193. L.R. Brown and H. Kane, *Full House. Reassessing the Earth's Population Carrying Capacity*, W.W. Norton, New York, (1991).
194. L.R. Brown, *Seeds of Change*, Praeger Publishers, New York, (1970).
195. L.R. Brown, *The Worldwide Loss of Cropland*, Worldwatch Paper 24, Worldwatch Institute, Washington, D.C., (1978).
196. L.R. Brown, and J.L. Jacobson, *Our Demographically Divided World*, Worldwatch Paper 74, Worldwatch Institute, Washington D.C., (1986).
197. L.R. Brown, and J.L. Jacobson, *The Future of Urbanization: Facing the Ecological and Economic Constraints*, Worldwatch Paper 77, Worldwatch Institute, Washington D.C., (1987).
198. L.R. Brown, and others, *State of the World*, W.W. Norton, New York, (published annually).
199. H. Brown, *The Human Future Revisited. The World Predicament and Possible Solutions*, W.W. Norton, New York, (1978).
200. H. Hanson, N.E. Borlaug and N.E. Anderson, *Wheat in the Third World*, Westview Press, Boulder, Colorado, (1982).
201. A. Dil, ed., *Norman Borlaug and World Hunger*, Bookservice International, San Diego/Islamabad/Lahore, (1997).
202. N.E. Borlaug, *The Green Revolution Revisited and the Road Ahead*, Norwegian Nobel Institute, Oslo, Norway, (2000).

203. N.E. Borlaug, *Ending World Hunger. The Promise of Biotechnology and the Threat of Antiscience Zealotry*, *Plant Physiology*, **124**, 487-490, (2000).
204. M. Giampietro and D. Pimental, *The Tightening Conflict: Population, Energy Use and the Ecology of Agriculture*, in *Negative Population Forum*, L. Grant ed., Negative Population Growth, Inc., Teaneck, N.J., (1993).
205. H.W. Kendall and D. Pimental, *Constraints on the Expansion of the Global Food Supply*, *Ambio*, **23**, 198-2005, (1994).
206. D. Pimental et al., *Natural Resources and Optimum Human Population*, *Population and Environment*, **15**, 347-369, (1994).
207. D. Pimental et al., *Environmental and Economic Costs of Soil Erosion and Conservation Benefits*, *Science*, **267**, 1117-1123, (1995).
208. D. Pimental et al., *Natural Resources and Optimum Human Population*, *Population and Environment*, **15**, 347-369, (1994).
209. D. Pimental and M. Pimental, *Food Energy and Society*, University Press of Colorado, Niwot, Colorado, (1996).
210. D. Pimental et al., *Environmental and Economic Costs of Soil Erosion and Conservation Benefits*, *Science*, **267**, 1117-1123, (1995).
211. RS and NAS, *The Royal Society and the National Academy of Sciences on Population Growth and Sustainability*, *Population and Development Review*, **18**, 375-378, (1992).
212. A.M. Altieri, *Agroecology: The Science of Sustainable Agriculture*, Westview Press, Boulder, Colorado, (1995).
213. G. Conway, *The Doubly Green Revolution*, Cornell University Press, (1997).
214. J. Dreze and A. Sen, *Hunger and Public Action*, Oxford University Press, (1991).
215. G. Bridger, and M. de Soissons, *Famine in Retreat?*, Dent, London, (1970).
216. W. Brandt, *World Armament and World Hunger: A Call for Action*, Victor Gollanz Ltd., London, (1982).
217. A.K.M.A. Chowdhury and L.C. Chen, *The Dynamics of Contemporary Famine*, Ford Foundation, Dacca, Pakistan, (1977)
218. J. Shepard, *The Politics of Starvation*, Carnegie Endowment for International Peace, Washington D.C., (1975).
219. M.E. Clark, *Ariadne's Thread: The Search for New Modes of Thinking*, St. Martin's Press, New York, (1989).
220. J.-C. Chesnais, *The Demographic Transition*, Oxford, (1992).
221. C.M. Cipola, *The Economic History of World Population*, Penguin Books Ltd., (1974).
222. E. Draper, *Birth Control in the Modern World*, Penguin Books, Ltd., (1972).
223. Draper Fund Report No. 15, *Towards Smaller Families: The Crucial Role of the Private Sector*, Population Crisis Committee, 1120 Nineteenth Street, N.W., Washington D.C. 20036, (1986).
224. E. Eckholm, *Losing Ground: Environmental Stress and World Food Prospects*, W.W. Norton, New York, (1975).
225. E. Havemann, *Birth Control*, Time-Life Books, (1967).

226. J. Jacobsen, *Promoting Population Stabilization: Incentives for Small Families*, Worldwatch Paper 54, Worldwatch Institute, Washington D.C., (1983).
227. N. Keyfitz, *Applied Mathematical Demography*, Wiley, New York, (1977).
228. W. Latz (ed.), *Future Demographic Trends*, Academic Press, New York, (1979).
229. World Bank, *Poverty and Hunger: Issues and Options for Food Security in Developing Countries*, Washington D.C., (1986).
230. J.E. Cohen, *How Many People Can the Earth Support?*, W.W. Norton, New York, (1995).
231. J. Amos, *Climate Food Crisis to Deepen*, BBC News (5 September, 2005).
232. J. Vidal and T. Ratford, *One in Six Countries Facing Food Shortage*, The Guardian, (30 June, 2005).
233. J. Mann, *Biting the Environment that Feeds Us*, The Washington Post, July 29, 1994.
234. G.R. Lucas, Jr., and T.W. Ogletree, (editors), *Lifeboat Ethics. The Moral Dilemmas of World Hunger*, Harper and Row, New York.
235. J.L. Jacobson, *Gender Bias: Roadblock to Sustainable Development*, Worldwatch Paper 110, Worldwatch Institute, Washington D.C., (1992).
236. J. Gever, R. Kaufmann, D. Skole and C. Vorosmarty, *Beyond Oil: The Threat to Food and Fuel in the Coming Decades*, Ballinger, Cambridge MA, (1986).
237. M. ul Haq, *The Poverty Curtain: Choices for the Third World*, Columbia University Press, New York, (1976).
238. H. Le Bras, *La Planète au Village*, Datar, Paris, (1993).
239. E. Mayr, *Population, Species and Evolution*, Harvard University Press, Cambridge, (1970).
240. Patz, J. A., Campbell-Lendrum, D., Holloway, T. and Foley, J. A. *Impact of regional climate change on human health*. *Nature* **438**, 310-317 (2005).
241. Basu, R. and Samet, J. M. *Relation between elevated ambient temperature and mortality: a review of the epidemiologic evidence*. *Epidemiol. Rev.* **24**, 190-202 (2002).
242. Kovats, R. S. and Hajat, S. *Heat stress and public health: a critical review*. *Annu. Rev. Publ. Health* **29**, 41-55 (2008).
243. Leon, L. R. *Pathophysiology of Heat Stroke* **Vol. 7** (Colloquium Series on Integrated Systems Physiology: From Molecule to Function to Disease, Morgan Claypool Life Sciences, 2015).
244. Ostro, B. D., Roth, L. A., Green, R. S. and Basu, R. *Estimating the mortality effect of the July 2006 California heat wave*. *Environ. Res.* **109**, 614-619 (2009).
245. Glas er, J. et al. *Climate change and the emergent epidemic of CKD from heat stress in rural communities: the case for heat stress nephropathy*. *Clin. J. Am. Soc. Nephrol.* **11**, 1472-1483 (2016).
246. Robine, J.-M. et al. *Death toll exceeded 70,000 in Europe during the summer of 2003*. *C. R. Biol.* **331**, 171-178 (2008).
247. Sillmann, J. and Roeckner, E. *Indices for extreme events in projections of anthropogenic climate change*. *Climatic Change* **86**, 83-104 (2008).
248. Meehl, G. A. and Tebaldi, C. *More intense, more frequent, and longer lasting heat waves in the 21st century*. *Science* **305**, 994-997 (2004).

249. Orłowsky, B. and Seneviratne, S. *Global changes in extreme events: regional and seasonal dimension*. Climatic Change **110**, 669-696 (2012).
250. Tebaldi, C., Hayhoe, K., Arblaster, J. M. and Meehl, G. A. *Going to the extremes*. Climatic Change **79**, 185-211 (2006).
251. Tebaldi, C. and Wehner, M. F. *Benefits of mitigation for future heat extremes under RCP4.5 compared to RCP8.5*. Climatic Change <http://dx.doi.org/10.1007/s10584-016-1605-5> (2016).
252. Sterl, A. et al. *When can we expect extremely high surface temperatures?* Geophys. Res. Lett. **35**, L14703 (2008).
253. Huang, C. et al. *Projecting future heat-related mortality under climate change scenarios: a systematic review*. Environ. Health Persp. **119**, 1681-1690 (2011).
254. Guo, Y. et al. *Global variation in the effects of ambient temperature on mortality: a systematic evaluation*. J. Epidemiol. **25**, 781-789 (2014).
255. Luber, G. and McGeehin, M. *Climate change and extreme heat events*. Am. J. Prev. Med. **35**, 429-435 (2008).
256. Bouchama, A. and Knochel, J. P. *Heat stroke*. New. Engl. J. Med. **346**, 1978-1988 (2002).
257. Bobb, J. F., Peng, R. D., Bell, M. L. and Dominici, F. *Heat-related mortality and adaptation to heat in the United States*. Environ. Health Persp. **122**, 811-816 (2014).
258. Gasparrini, A. et al. *Temporal variation in heat-mortality associations: a multi-country study*. Environ. Health Persp. **123**, 1200-1207 (2015).
259. Lowe, D., Ebi, K. L. and Forsberg, B. *Heatwave early warning systems and adaptation advice to reduce human health consequences of heatwaves*. Int. J. Environ. Res. Public Health **8**, 4623-4648 (2011).
260. Hanna, E. G. and Tait, P. W. *Limitations to thermoregulation and acclimatization challenge human adaptation to global warming*. Int. J. Environ. Res. Publ. Health. **12**, 8034-8074 (2015).
261. Sherwood, S. C. and Huber, M. *An adaptability limit to climate change due to heat stress*. Proc. Natl Acad. Sci. USA **107**, 9552-9555 (2010).
262. Whitman, S. et al. *Mortality in Chicago attributed to the July 1995 heat wave*. Am. J. Public Health **87**, 1515-1518 (1997).
263. Dousset, B. et al. *Satellite monitoring of summer heat waves in the Paris metropolitan area*. Int. J. Climatol. **31**, 313-323 (2011).
264. Shaposhnikov, D. et al. *Mortality related to air pollution with the Moscow heat wave and wildfire of 2010*. Epidemiology **25**, 359-364 (2014).
265. Barnett, A. G., Tong, S. and Clements, A. *What measure of temperature is the best predictor of mortality?* Environ. Res. **110**, 604-611 (2010).
266. Willett, K. M. and Sherwood, S. *Exceedance of heat index thresholds for 15 regions under a warming climate using the wet-bulb globe temperature*. Int. J. Climatol. **32**, 161-177 (2012).
267. Argüeso, D., Di Luca, A., Perkins-Kirkpatrick, S. and Evans, J. P. *Seasonal mean temperature changes control future heatwaves*. Geophys. Res. Lett. **43**, 7653-7660 (2016).

268. Jones, B. and O'Neill, B. *Spatially explicit global population scenarios consistent with the Shared Socioeconomic Pathways*. Environ. Res. Lett. **11**, 084003 (2016).
269. Diffenbaugh, N. S. and Field, C. B. *Changes in ecologically critical terrestrial climate conditions*. Science **341**, 486-492 (2013).
270. Mitchell, D. et al. *Attributing human mortality during extreme heat waves to anthropogenic climate change*. Environ. Res. Lett. **11**, 074006 (2016).
271. P. Dasgupta, *Population, Resources and Poverty*, Ambio, **21**, 95-101, (1992).
272. L.R. Brown, *Who Will Feed China?*, W.W. Norton, New York, (1995).
273. L.R. Brown, et al., *Saving the Planet. How to Shape and Environmentally Sustainable Global Economy*, W.W. Norton, New York, (1991).
274. L.R. Brown, *Postmodern Malthus: Are There Too Many of Us to Survive?*, The Washington Post, July 18, (1993).
275. L.R. Brown and H. Kane, *Full House. Reassessing the Earth's Population Carrying Capacity*, W.W. Norton, New York, (1991).
276. L.R. Brown, *Seeds of Change*, Praeger Publishers, New York, (1970).
277. L.R. Brown, *The Worldwide Loss of Cropland*, Worldwatch Paper 24, Worldwatch Institute, Washington, D.C., (1978).
278. L.R. Brown, and J.L. Jacobson, *Our Demographically Divided World*, Worldwatch Paper 74, Worldwatch Institute, Washington D.C., (1986).
279. L.R. Brown, and J.L. Jacobson, *The Future of Urbanization: Facing the Ecological and Economic Constraints*, Worldwatch Paper 77, Worldwatch Institute, Washington D.C., (1987).
280. L.R. Brown, and others, *State of the World*, W.W. Norton, New York, (published annually).
281. H. Brown, *The Human Future Revisited. The World Predicament and Possible Solutions*, W.W. Norton, New York, (1978).
282. H. Hanson, N.E. Borlaug and N.E. Anderson, *Wheat in the Third World*, Westview Press, Boulder, Colorado, (1982).
283. A. Dil, ed., *Norman Borlaug and World Hunger*, Bookservice International, San Diego/Islamabad/Lahore, (1997).
284. N.E. Borlaug, *The Green Revolution Revisited and the Road Ahead*, Norwegian Nobel Institute, Oslo, Norway, (2000).
285. N.E. Borlaug, *Ending World Hunger. The Promise of Biotechnology and the Threat of Antiscience Zealotry*, Plant Physiology, **124**, 487-490, (2000).
286. M. Giampietro and D. Pimental, *The Tightening Conflict: Population, Energy Use and the Ecology of Agriculture*, in **Negative Population Forum**, L. Grant ed., Negative Population Growth, Inc., Teaneck, N.J., (1993).
287. H.W. Kendall and D. Pimental, *Constraints on the Expansion of the Global Food Supply*, Ambio, **23**, 198-2005, (1994).
288. D. Pimental et al., *Natural Resources and Optimum Human Population*, Population and Environment, **15**, 347-369, (1994).
289. D. Pimental et al., *Environmental and Economic Costs of Soil Erosion and Conservation Benefits*, Science, **267**, 1117-1123, (1995).

290. D. Pimental et al., *Natural Resources and Optimum Human Population*, Population and Environment, **15**, 347-369, (1994).
291. D. Pimental and M. Pimental, *Food Energy and Society*, University Press of Colorado, Niwot, Colorado, (1996).
292. D. Pimental et al., *Environmental and Economic Costs of Soil Erosion and Conservation Benefits*, Science, **267**, 1117-1123, (1995).
293. RS and NAS, *The Royal Society and the National Academy of Sciences on Population Growth and Sustainability*, Population and Development Review, **18**, 375-378, (1992).
294. A.M. Altieri, *Agroecology: The Science of Sustainable Agriculture*, Westview Press, Boulder, Colorado, (1995).
295. G. Conway, *The Doubly Green Revolution*, Cornell University Press, (1997).
296. J. Dreze and A. Sen, *Hunger and Public Action*, Oxford University Press, (1991).
297. G. Bridger, and M. de Soissons, *Famine in Retreat?*, Dent, London, (1970).
298. W. Brandt, *World Armament and World Hunger: A Call for Action*, Victor Gollanz Ltd., London, (1982).
299. A.K.M.A. Chowdhury and L.C. Chen, *The Dynamics of Contemporary Famine*, Ford Foundation, Dacca, Pakistan, (1977).
300. J. Shepard, *The Politics of Starvation*, Carnegie Endowment for International Peace, Washington D.C., (1975).
301. M.E. Clark, *Ariadne's Thread: The Search for New Modes of Thinking*, St. Martin's Press, New York, (1989).
302. C.M. Cipola, *The Economic History of World Population*, Penguin Books Ltd., (1974).
303. E. Draper, *Birth Control in the Modern World*, Penguin Books, Ltd., (1972).
304. Draper Fund Report No. 15, *Towards Smaller Families: The Crucial Role of the Private Sector*, Population Crisis Committee, 1120 Nineteenth Street, N.W., Washington D.C. 20036, (1986).
305. E. Eckholm, *Losing Ground: Environmental Stress and World Food Prospects*, W.W. Norton, New York, (1975).
306. E. Havemann, *Birth Control*, Time-Life Books, (1967).
307. J. Jacobsen, *Promoting Population Stabilization: Incentives for Small Families*, Worldwatch Paper 54, Worldwatch Institute, Washington D.C., (1983).
308. N. Keyfitz, *Applied Mathematical Demography*, Wiley, New York, (1977).
309. W. Latz (ed.), *Future Demographic Trends*, Academic Press, New York, (1979).
310. World Bank, *Poverty and Hunger: Issues and Options for Food Security in Developing Countries*, Washington D.C., (1986).
311. J.E. Cohen, *How Many People Can the Earth Support?*, W.W. Norton, New York, (1995).
312. J. Amos, *Climate Food Crisis to Deepen*, BBC News (5 September, 2005).
313. J. Vidal and T. Ratford, *One in Six Countries Facing Food Shortage*, The Guardian, (30 June, 2005).
314. J. Mann, *Biting the Environment that Feeds Us*, The Washington Post, July 29, 1994.

315. G.R. Lucas, Jr., and T.W. Ogletree, (editors), *Lifeboat Ethics. The Moral Dilemmas of World Hunger*, Harper and Row, New York.
316. J.L. Jacobson, *Gender Bias: Roadblock to Sustainable Development*, Worldwatch Paper 110, Worldwatch Institute, Washington D.C., (1992).
317. J. Gever, R. Kaufmann, D. Skole and C. Vorosmarty, *Beyond Oil: The Threat to Food and Fuel in the Coming Decades*, Ballinger, Cambridge MA, (1986).
318. M. ul Haq, *The Poverty Curtain: Choices for the Third World*, Columbia University Press, New York, (1976).
319. H. Le Bras, *La Planète au Village*, Datar, Paris, (1993).
320. E. Mayr, *Population, Species and Evolution*, Harvard University Press, Cambridge, (1970).
321. N.E. Borlaug, *Ending World Hunger. The Promise of Biotechnology and the Threat of Antiscience Zealotry*, *Plant Physiology*, **124**, 487-490, (2000).
322. M. Giampietro and D. Pimentel, *The Tightening Conflict: Population, Energy Use and the Ecology of Agriculture*, in *Negative Population Forum*, L. Grant ed., Negative Population Growth, Inc., Teaneck, N.J., (1993).
323. H.W. Kendall and D. Pimentel, *Constraints on the Expansion of the Global Food Supply*, *Ambio*, **23**, 198-2005, (1994).
324. D. Pimentel et al., *Natural Resources and Optimum Human Population*, *Population and Environment*, **15**, 347-369, (1994).
325. D. Pimentel et al., *Environmental and Economic Costs of Soil Erosion and Conservation Benefits*, *Science*, **267**, 1117-1123, (1995).
326. RS and NAS, *The Royal Society and the National Academy of Sciences on Population Growth and Sustainability*, *Population and Development Review*, **18**, 375-378, (1992).
327. A.M. Altieri, *Agroecology: The Science of Sustainable Agriculture*, Westview Press, Boulder, Colorado, (1995).
328. J. Dreze and A. Sen, *Hunger and Public Action*, Oxford University Press, (1991).
329. B. Commoner, *The Closing Circle: Nature, Man and Technology*, Bantam Books, New York, (1972).
330. Council on Environmental Quality and U.S. Department of State, *Global 2000 Report to the President: Entering the Twenty-First Century*, Technical Report, Volume 2, U.S. Government Printing Office, Washington D.C., (1980).
331. A.B. Durning, *Action at the Grassroots: Fighting Poverty and Environmental Decline*, Worldwatch Paper , Worldwatch Institute, Washington D.C., (1989).
332. P. Donaldson, *Worlds Apart: The Economic Gulf Between Nations*, Penguin Books Ltd., (1973).
333. J.C.I. Dooge et al. (editors), *Agenda of Science for Environment and Development into the 21st Century*, Cambridge University Press, (1993).
334. E. Draper, *Birth Control in the Modern World*, Penguin Books, Ltd., (1972).
335. Draper Fund Report No. 15, *Towards Smaller Families: The Crucial Role of the Private Sector*, Population Crisis Committee, 1120 Nineteenth Street, N.W., Washington D.C. 20036, (1986).

336. Economic Commission for Europe, *Air Pollution Across Boundaries*, United Nations, New York, (1985).
337. A.H. Ehrlich and U. Lele, *Humankind at the Crossroads: Building a Sustainable Food System*, in *Draft Report of the Pugwash Study Group: The World at the Crossroads*, Berlin, (1992).
338. P.R. Ehrlich, *The Population Bomb*, Sierra/Ballentine, New York, (1972).
339. P.R. Ehrlich, A.H. Ehrlich and J. Holdren, *Human Ecology*, W.H. Freeman, San Francisco, (1972).
340. P.R. Ehrlich, A.H. Ehrlich and J. Holdren, *Ecoscience: Population, Resources, Environment*, W.H. Freeman, San Francisco, (1977).
341. P.R. Ehrlich and A.H. Ehrlich, *Extinction*, Victor Gollancz, London, (1982).
342. P.R. Ehrlich and A.H. Ehrlich, *Healing the Planet*, Addison Wesley, Reading MA, (1991).
343. P.R. Ehrlich and A.H. Ehrlich, *The Population Explosion*, Arrow Books, (1991).
344. I. Eibl-Eibesfeldt, *The Biology of War and Peace*, Thames and Hudson, New York, (1979).
345. Food and Agricultural Organization, *The State of Food and Agriculture*, United Nations, Rome, (published annually).
346. K. Griffin, *Land Concentration and Rural Poverty*, Holmes and Meyer, New York, (1976).
347. G. Hagman and others, *Prevention is Better Than Cure*, Report on Human Environmental Disasters in the Third World, Swedish Red Cross, Stockholm, Stockholm, (1986).
348. M. ul Haq, *The Poverty Curtain: Choices for the Third World*, Columbia University Press, New York, (1976).
349. E. Mayr, *Population, Species and Evolution*, Harvard University Press, Cambridge, (1970).
350. N. Myers, *The Sinking Ark*, Pergamon, New York, (1972).
351. N. Myers, *Conservation of Tropical Moist Forests*, National Academy of Sciences, Washington D.C., (1980).
352. K. Newland, *Infant Mortality and the Health of Societies*, Worldwatch Paper 47, Worldwatch Institute, Washington D.C., (1981).
353. W. Ophuls, *Ecology and the Politics of Scarcity*, W.H. Freeman, San Francisco, (1977).
354. D.W. Orr, *Ecological Literacy*, State University of New York Press, Albany, (1992).
355. A. Peccei, *The Human Quality*, Pergamon Press, Oxford, (1977).
356. A. Peccei, *One Hundred Pages for the Future*, Pergamon Press, New York, (1977).
357. A. Peccei and D. Ikeda, *Before it is Too Late*, Kodansha International, Tokyo, (1984).
358. E. Pestel, *Beyond the Limits to Growth*, Universe Books, New York, (1989).
359. Bonan, G. B. (2008). *Forests and climate change: Forcings, feedbacks, and the climate benefits of forests*. *Science*. **320** (5882): 1444-1449.
360. Scheil, D.; Murdiyarso, D. (2009). *How Forests Attract Rain: An Examination of a New Hypothesis*. *BioScience*. **59** (4): 341-347.

361. Ahmad, Y.J. and M. Kassas. 1987. *Desertification: Financial Support for the Biosphere*. West Hartford, Conn.: Kumarian Press.
362. Barrow, C. J. 1991. *Land Degradation - Developments and Breakdown of Terrestrial Environments*. Cambridge: Cambridge University Press.
363. Gadgil, M. 1989. *Deforestation: Problems and prospects*. Foundation Day Lecture, Society for Promotion of Wastelands Development, 12 May, New Delhi. Centre of Ecological Sciences and Theoretical Studies, Indian Institute of Science Bangalore.
364. Government of India. 1987. *State of Forest Report 1987*. Forest Survey of India, Dehradun.
365. Government of India. 1991. *State of Forest Report, 1987-1989*. Forest Survey of India, Dehradun.
366. Kassas, M. 1987. *Drought and desertification*. *Land Use Policy* **4(4)**: 389-400.
367. Kemp, D. D. 1990. *Global Environmental Issues - A Climatological Approach*. London: Routledge.
368. Maheshwari, J. K. 1989. *Processing and Utilization of Perennial Vegetation in the Arid Zone of India* in **Role of Forestry in Combatting Desertification**. Rome: FAO Conservation Guide 21, pp. 137-172.
369. Reining, P. 1978. *Handbook on Desertification Indicators*. Washington, D.C.: American Association for the Advancement of Science.
370. Tolba, M. K. 1987. *Sustainable Development: Constraints and Opportunities* London: Butterworth.
371. Tolba, M. K., O. A. El-Kholy, et al. 1992. *The World Environment 1972-1992. Two Decades of Challenge*. London: Chapman and Hall.
372. Tucker, C. J., H. E. Dregne, and W. W. Newcomb. 1991. *Expansion and contraction of Sahara Desert from 1980-1990*. *Science* **253**.
373. UNCED (United Nations Conference on Environment and Development). 1992. *Agenda 21*. United Nations Conference on Environment and Development, Brazil, June 3-14,1992. Brazil: UNCED.
374. UNEP (United Nations Environment Programme). 1984. *General Assessment of Progress in the Implementation of the Plan of Action to Combat Desertification, 1978-1984*. GC-12/9.
375. UNEP (United Nations Environment Programme). 1991. *Status of Desertification and Implementation of the United Nations Plan of Action to Control Desertification*. Nairobi: UNEP.
376. Winpenny, J. T. (ed.). 1990. *Development Research: The Environmental Challenge*. Boulder, Colo.: Westview Press, for the ODI.
377. Wood, W. B. 1990. *Tropical Deforestation. Balancing Regional Development Demands and Global Environmental Concerns*.
378. World Bank. 1992. *World Development Report 1992*. Oxford: Oxford University Press.

Chapter 10

STEPS NEEDED FOR POPULATION STABILIZATION

10.1 All the needed reforms are desirable in themselves

Experts agree that the following steps are needed if we are to avoid a catastrophic global famine and population crash:

1. Higher education and higher status for women throughout the world. Women need higher education to qualify for jobs outside their homes, and higher status within their families so they will not be forced into the role of baby-producing machines.
2. Primary health care for all. Children should be vaccinated against preventable diseases. Materials and information for family planning should be provided for all women who desire smaller families. Advice should be given on improving sanitation.
3. The provision of clean water supplies near to homes is needed in order to reduce the incidence of water-borne diseases. In some countries today, family members, including children, spend large amounts of time carrying water home from distant sources.
4. State provision of care for the elderly is a population-stabilization measure because in many countries, parents produce many children so that the children will provide for them in their old age.
5. In many countries child labor is common, and in some there is even child slavery. Parents who regard their children as a source of income are motivated to produce large families. Enforceable laws against child labor and slavery contribute to population stabilization.
6. General economic progress has been observed to contribute to population stabilization. However in some countries there is a danger of population growing so rapidly that it prevents the economic progress that would otherwise have stabilized population. This situation is known as the demographic trap.



Figure 10.1: **Professor Sir Partha Dasgupta of Cambridge University has pointed out that all of the steps that are needed for population stabilization are desirable in themselves.**

10.2 Higher status and higher education for women

It is only recently that women have had the right to vote. In most of the industrialized countries, this right was only granted during the early part of the 20th century. In some countries, this reform was even slower. For example, in Switzerland, it was only in 1971 that women gained the right to vote in federal elections. In Lichtenstein, women's right to vote was delayed until 1981. It was only in December, 2015 that Saudi Arabia granted the right to vote to women. Currently, the only country in the world where this right is denied is the Vatican City.

It is important that women should have equal political representation because female representation not only advances gender equality in legal matters, such as the inheritance of property, but also promotes the rights of children.

Prior to the 20th century, women were very largely barred from higher education. For example, the famous pioneer of modern educational methods, Dr. Maria Montessori, had to overcome many barriers to obtain her medical degree.

With higher education, comes the motivation and the opportunity for women to have jobs outside their homes. With lower rates of infant mortality, and the aid of machines, being a housewife and mother has become less and less a lifelong full-time occupation. Experts agree that higher education for women, and jobs for women outside their homes are vitally important measures for population stabilization; but these reforms are also very desirable for their own sake, for the sake of justice, and for the sake of the uniquely life-oriented vision that women can bring to public life.



Figure 10.2: Higher education and higher political representation for women are vitally needed reforms.

10.3 Primary health care for all

An International Conference on Primary Health Care took place at Alma-Ata, USSR, 6-12 September, 1978. Point **VII** of the Alma-Ata Declaration defines primary health care as follows:

Primary health care

1. *reflects and evolves from the economic conditions and sociocultural and political characteristics of the country and its communities and is based on the application of the relevant results of social, biomedical and health services research and public health experience;*
2. *addresses the main health problems in the community, providing promotive, preventive, curative and rehabilitative services accordingly;*
3. *includes at least: education concerning prevailing health problems and the methods of preventing and controlling them; promotion of food supply and proper nutrition; an adequate supply of safe water and basic sanitation; maternal and child health care, including family planning; immunization against the major infectious diseases; prevention and control of locally endemic diseases; appropriate treatment of common diseases and injuries; and provision of essential drugs;*
4. *involves, in addition to the health sector, all related sectors and aspects of national and community development, in particular agriculture, animal husbandry, food, industry, education, housing, public works, communications and other sectors; and demands the coordinated efforts of all those sectors;*
5. *requires and promotes maximum community and individual self-reliance and participation in the planning, organization, operation and control of primary health care,*



Figure 10.3: The provision of primary health care to all countries throughout the world should include not only measures, such as vaccination, for the prevention of diseases, but also making advice and materials for family planning available to all women who desire them.



Figure 10.4: Bill and Melinda Gates.

making fullest use of local, national and other available resources; and to this end develops through appropriate education the ability of communities to participate;

- 6. should be sustained by integrated, functional and mutually supportive referral systems, leading to the progressive improvement of comprehensive health care for all, and giving priority to those most in need;*
- 7. relies, at local and referral levels, on health workers, including physicians, nurses, midwives, auxiliaries and community workers as applicable, as well as traditional practitioners as needed, suitably trained socially and technically to work as a health team and to respond to the expressed health needs of the community.*

Provision of primary health care is high on the list of priorities of the World Health Organization. The Bill and Melinda Gates Foundation has also made great financial contributions to this goal.



Figure 10.5: Carrying water from distant sources to homes is a time-consuming burden. Often this task is performed by children.

10.4 Clean water supplies near homes

According to the World Health Organization, 842,000 deaths per year are attributable to a lack of safe drinking water supply, sanitation and hygiene. Wikipedia states that “Waterborne diseases can have a significant impact on the economy, locally as well as internationally. People who are infected by a waterborne disease are usually confronted with related costs and not seldom with a huge financial burden. This is especially the case in less developed countries. The financial losses are mostly caused by e.g. costs for medical treatment and medication, costs for transport, special food, and by the loss of manpower. Many families must even sell their land to pay for treatment in a proper hospital. On average, a family spends about 10% of the monthly households income per person infected.”

10.5 State provision of care for the elderly

In many countries, elderly parents have traditionally been cared for by their children. This is one of the motives for large family size. Parents with many children feel that they will have a secure old age. For example, in India, parents are typically cared for by their children into old age, most commonly by their sons. Thus, many parents in India continue to have children until they produce a son, and this often leads to large family sizes. State supported care for the elderly throughout the world is an important step that is needed for population stabilization.



Figure 10.6: **Government-provided care for the elderly will help to stabilize the currently-exploding global population of humans.**

10.6 Abolition of child labor and slavery

Today the hard-won achievements of reformers in the industrialized countries are being undermined and lost because of uncritical and unregulated globalization. A factory owner or CEO, anxious to avoid high labor costs, and anxious to violate environmental regulations merely moves his factory to a country where laws against child labor and rape of the environment do not exist or are poorly enforced. In fact, he must do so or be fired, since the only thing that matters to the stockholders is the bottom line. One might say (as someone has done), that Adam Smith's invisible hand is at the throat of the world's peoples and at the throat of the global environment.

The movement of a factory from Europe or North America to a country with poorly enforced laws against environmental destruction, child labor and slavery puts workers into unfair competition. Unless they are willing to accept revival of the unspeakable conditions of the early Industrial Revolution, they are unable to compete.

Today, child labor accounts for 22% of the workforce in Asia, 32% in Africa, and 17% in Latin America. Large-scale slavery also exists today, although there are formal laws against it in every country. There are more slaves now than ever before - their number is estimated to be between 12 million and 27 million. Besides outright slaves, who are bought and sold for as little as 100 dollars, there many millions of workers whose lack of options and dreadful working conditions must be described as slave-like.

We need to reform our economic system to give it both a social conscience and an ecological conscience. Perhaps some of the things that the world produces and consumes today are not really necessary.



Figure 10.7: Laws prohibiting child labor are non-existent in many countries, or poorly enforced.



Figure 10.8: More slaves exist today than ever before.

10.7 General economic progress

It has been observed that general economic progress leads to population stabilization. However, it often happens that population growth in a country is so rapid that it prevents economic progress. This phenomenon is known as the *demographic trap*. For example, if we look at the population-age structure of Egypt in 2005, shown in Figure 2.9, we see that there are very many young people approaching reproductive age, and very few old people. Thus the birth rate will not be balanced by the death rate, and the population of any country with a similar population-age structure can be expected to grow rapidly, preventing the economic development that might have slowed population growth. In such a situation, strong state-supported birth control programs are clearly needed.

Very early marriage and forced marriage must also be discouraged. We can recall that Malthus mentions late marriage as one of the preventive checks to population growth. Forced and child marriages entrap women and young girls in relationships that deprive them of their basic human rights. Forced marriage constitutes a human rights violation in and of itself.

According to the website Stop Violence Against Women, “In 2003, the International Centre for Research on Women estimated that more than 51 million girls under 18 years were married and they expected the figure to rise to over 100 million within the next ten years. Similarly, in 2006, experts estimated that thirty-eight percent of young women aged 20 to 24 in the fifty least developed countries were married before the age of 18.

“In *Early Marriage: A Harmful Traditional Practice*, UNICEF estimates that among women aged 15 to 24, 48 percent were married before the age of 18 in South Asia. In Bangladesh, 27.3 percent of women aged 15 to 19 years old were married by the age of 15, and 65.3 percent of women aged 20 to 24 were married before the age of 18.

“UNICEF estimates that in Africa 42 percent of women aged 15 to 24 were married before the age of 18. In Niger, 27.3 percent of women ages 15 to 19 were married before the age of 15, and 76.6 percent of women ages 20 to 24 were married before the age of 18. According to surveys conducted by the National Committee on Traditional Practices of Ethiopia (NCTPE), the prevalence of marriage by abduction is as high as 92 per cent in Southern Nations Nationalities and Peoples Region (SNNPR), with a national average of 69 percent.”

Today’s world is one in which the wealth of the richest 1% of the global population increased by 82% in 2017, while for the poorest half of humanity there was no increase at all. It is a world where an estimated 11 million children die every year from starvation or from diseases related to poverty. It is a world where obesity is a serious public health problem in rich nations, while at the same time, children in poorer countries scavenge among toxic wastes in garbage dumps. It is a world where almost a billion people are undernourished.

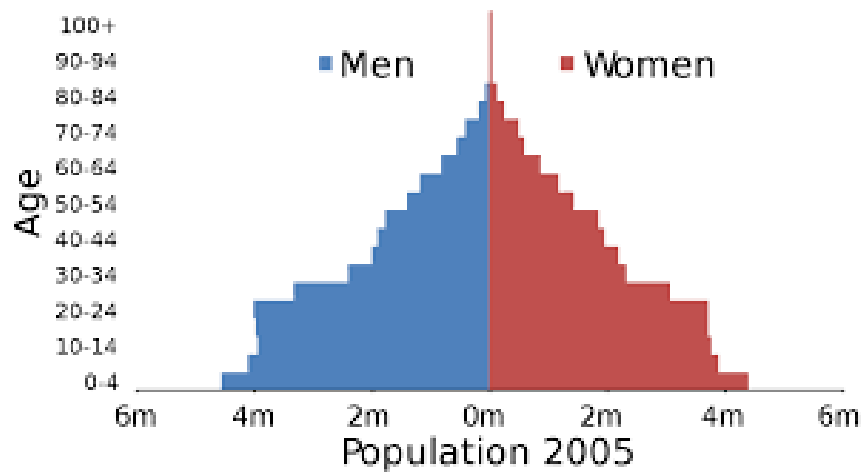

Figure 10.9: The population pyramid of Egypt in 2005.



Figure 10.10: A slum in India



Figure 10.11: Children scavenging at a garbage dump.

10.8 Population projections in Africa

Wikipedia's article on *Projections of Population Growth* states that "By 2070, the bulk of the world's population growth will take place in Africa: of the additional 2.4 billion people projected between 2015 and 2050, 1.3 billion will be added in Africa, 0.9 billion in Asia and only 0.2 billion in the rest of the world. Africa's share of global population is projected to grow from 16% in 2015 to 25% in 2050 and 39% by 2100, while the share of Asia will fall from 60% in 2015 to 54% in 2050 and 44% in 2100. The strong growth of the African population will happen regardless of the rate of decrease of fertility, because of the exceptional proportion of young people already living today. For example, the UN projects that the population of Nigeria will surpass that of the United States by 2050."

"During 2005-2050, twelve countries are expected to account for half of the world's projected population increase: India, China, United States, Indonesia, Nigeria, Pakistan, Brazil, Democratic Republic of the Congo, Ethiopia, Philippines, Mexico and Egypt, listed according to the size of their contribution to population growth."

The predictions shown in Table 2.2, especially the prediction that the population of Africa will be 2.53 billion people, raise some worrying questions. It seems likely that because of climate change, failure of the West African monsoon, desertification, and sale of African agricultural land to rich countries such China and Saudi Arabia, the food available to the people of Africa will diminish rather than increasing. Can the population of Africa really increase by 209% by 2050? Or will this be prevented by the terrible Malthusian forces of famine, disease and war? In some parts of Africa famine is already present.

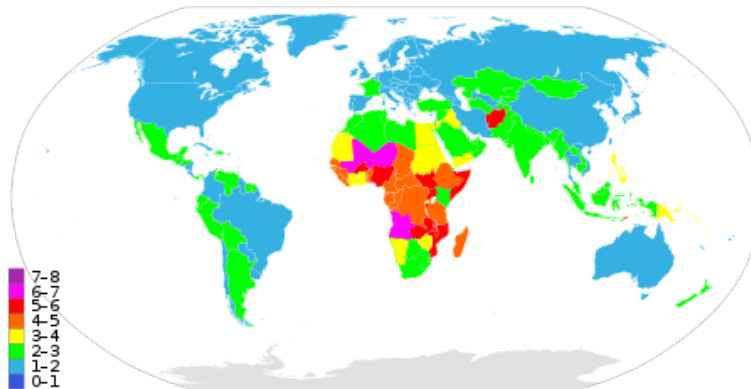

Figure 10.12: A map from the Wikipedia article showing global fertility rates in 2015. The highest fertility rates (purple, 7-8 children per woman-life) occur in Africa.

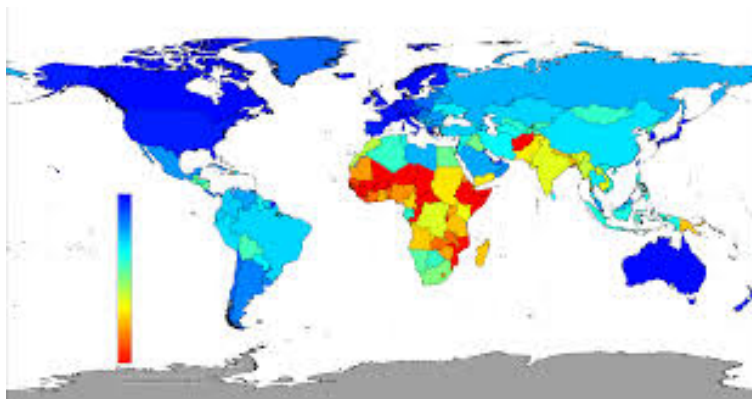

Figure 10.13: A map showing the human development index (HDI) in various parts of the world. The index is based on educational levels, life expectancy, and GDP per capita. It can be seen that regions of high fertility generally have low HDI values.

10.9 What is the future of megacities?

A transformation in cities is going on. Over 80% of the people on the planet today are living in cities. Over 100 new cities will be created within 25 years in China alone. Over 20 new Megacities will redefine the consumer marketplace and society. Most of these cities of over 8 million people each will be in the developing world. With the huge migration to cities of the global population, what challenges will these cities face? What are the opportunities and risks? How should global organizations prepare for the future of cities?

Transition Towns

The Transition Town Movement of today is a response to the end of the fossil fuel era and the threat of economic collapse. It can be thought of as a modern branch of the Cooperative Movement. In 2006, the Transition Town of Totnes in Devon, England was the first to use this name, which implied a transition from globalism, consumerism and growth to a sustainable, local and self-sufficient economy. The ideal was to produce locally all the necessary food for the town, and as much of other necessities as possible. In this way, the energy expenditures involved in transportation could be avoided.

Today there are more than a thousand Transition Towns and they are located in 43 countries. Many of them have local currencies which are legal tender within the town. If the pioneers of this movement are right in saying that this is the only sustainable model for the future, we may wonder whether mega-cities will be able to survive in the long-term future.¹

¹<https://en.wikipedia.org/wiki/Degrowth>
<http://commondreams.org/views/2015/07/31/we-are-all-greece>
<http://www.localfutures.org/>
<http://www.powells.com/biblio/7-9780871566430-2>

Table 10.1: **The World's Largest Cities in 2016**

| Rank | Name | Country | Population |
|------|---------------|---------------|------------|
| 1 | Tokyo | Japan | 38,140,000 |
| 2 | Shanghai | China | 34,000,000 |
| 3 | Jakarta | Indonesia | 31,500,000 |
| 4 | Delhi | India | 27,200,000 |
| 5 | Seoul | Korea | 25,600,000 |
| 6 | Guangzhou | China | 25,000,000 |
| 7 | Beijing | China | 24,900,000 |
| 8 | Manila | Philippines | 24,100,000 |
| 9 | Mumbai | India | 23,900,000 |
| 10 | New York City | United States | 23,876,155 |
| 11 | Shenzhen | China | 23,300,000 |
| 12 | Sao Paolo | Brazil | 21,242,939 |



Figure 10.14: Totnes, Devon, England: a transition town.

Suggestions for further reading

1. John Fielden, *The Curse of the Factory System*, (1836).
2. A. Smith, *The Theory of Moral Sentiments...* (1759), ed. D.D. Raphael and A.L. MacPhie, Clarendon, Oxford, (1976).
3. A. Smith, *An Inquiry into the Nature and Causes of the Wealth of Nations* (1776), Everyman edn., 2 vols., Dent, London, (1910).
4. Charles Knowlton *The Fruits of Philosophy, or The Private Companion of Young Married People*, (1832).
5. John A. Hobson, *John Ruskin, Social Reformer*, (1898).
6. E. Pease, *A History of the Fabian Society*, Dutton, New York, (1916).
7. G. Claeys, ed., *New View of Society, and other writings by Robert Owen*, Penguin Classics, (1991).
8. W. Bowden, *Industrial Society in England Towards the End of the Eighteenth Century*, MacMillan, New York, (1925).
9. G.D. Cole, *A Short History of the British Working Class Movement*, MacMillan, New York, (1927).
10. P. Deane, *The First Industrial Revolution*, Cambridge University Press, (1969).
11. Marie Boaz, *Robert Boyle and Seventeenth Century Chemistry*, Cambridge University Press (1958).
12. J.G. Crowther, *Scientists of the Industrial Revolution*, The Cresset Press, London (1962).
13. R.E. Schofield, *The Lunar Society of Birmingham*, Oxford University Press (1963).
14. L.T.C. Rolt, *Isambard Kingdom Brunel*, Arrow Books, London (1961).
15. J.D. Bernal, *Science in History*, Penguin Books Ltd. (1969).
16. Bertrand Russell, *The Impact of Science on Society*, Unwin Books, London (1952).
17. Wilbert E. Moore, *The Impact of Industry*, Prentice Hall (1965).

18. Charles Morazé, *The Nineteenth Century*, George Allen and Unwin Ltd., London (1976).
19. Carlo M. Cipolla (editor), *The Fontana Economic History of Europe*, Fontana/Collins, Glasgow (1977).
20. Martin Gerhard Geisbrecht, *The Evolution of Economic Society*, W.H. Freeman and Co. (1972).
21. P.N. Stearns, *The Industrial Revolution in World History*, Westview Press, (1998).
22. E.P. Thompson, *The Making of the English Working Class*, Penguin Books, London, (1980).
23. N.J. Smelser, *Social Change and the Industrial Revolution: An Application of Theory to the British Cotton Industry*, University of Chicago Press, (1959).
24. D.S. Landes, *The Unbound Prometheus: Technical Change and Industrial Development in Western Europe from 1750 to the Present, 2nd ed.*, Cambridge University Press, (2003).
25. S. Pollard, *Peaceful Conquest: The Industrialization of Europe, 1760-1970*, Oxford University Press, (1981).
26. M. Kranzberg and C.W. Pursell, Jr., eds., *Technology in Western Civilization*, Oxford University Press, (1981).
27. M.J. Daunton, *Progress and Poverty: An Economic and Social History of Britain, 1700-1850*, Oxford University Press, (1990).
28. L.R. Berlanstein, *The Industrial Revolution and Work in 19th Century Europe*, Routledge, (1992).
29. J.D. Bernal, *Science and Industry in the 19th Century*, Indiana University Press, Bloomington, (1970).
30. P.A. Brown, *The French Revolution in English History*, 2nd edn., Allen and Unwin, London, (1923).
31. E. Burke, *Reflections on the Revolution in France and on the Proceedings of Certain Societies in London Relative to that Event...*, Dent, London, (1910).
32. J.B. Bury, *The Idea of Progress*, MacMillan, New York, (1932).
33. I.R. Christie, *Stress and Stability in Late Eighteenth Century Britain; Reflections on the British Avoidance of Revolution* (Ford Lectures, 1983-4), Clarendon, Oxford, (1984).
34. H.T. Dickenson, *Liberty and Property, Political Ideology in Eighteenth Century Britain*, Holmes and Meier, New York, (1977).
35. W. Eltis, *The Classical Theory of Economic Growth*, St. Martin's, New York, (1984).
36. E. Halévy, *A History of the English People in the Nineteenth Century*, (transl. E.I. Watkin), 2nd edn., Benn, London, (1949).
37. E. Halévy, *The Growth of Philosophic Radicalism*, (transl. M. Morris), new edn., reprinted with corrections, Faber, London, (1952).
38. W. Hazlitt, *The Complete Works of William Hazlitt*, ed. P.P. Howe, after the edition of A.R. Walker and A. Glover, 21 vols., J.M. Dent, London, (1932).
39. W. Hazlitt, *A Reply to the Essay on Population by the Rev. T.R. Malthus...*, Longman, Hurst, Rees and Orme, London, (1807).

40. R. Heilbroner, *The Worldly Philosophers: The Lives, Times and Ideas of the Great Economic Thinkers*, 5th edn., Simon and Schuster, New York, (1980).
41. R.K. Kanth, *Political Economy and Laissez-Faire: Economics and Ideology in the Ricardian Era*, Rowman and Littlefield, Totowa N.J., (1986).
42. J.M. Keynes, *Essays in Biography*, in *The Collected Writings of John Maynard Keynes*, MacMillan, London, (1971-82).
43. F. Knight, *University Rebel: The Life of William Frend, 1757-1841*, Gollancz, London (1971).
44. M. Lamb, and C. Lamb, *The Works of Charles and Mary Lamb*, ed. E.V. Lucas, 7 vols., Methuen, London, (1903).
45. A. Lincoln, *Some Political and Social Ideas of English Dissent, 1763-1800*, Cambridge University Press, (1938).
46. D. Locke, *A Fantasy of Reason: The Life and Thought of William Godwin*, Routledge, London, (1980).
47. J. Locke, *Two Treatises on Government. A Critical Edition with an Introduction and Apparatus Criticus*, ed. P. Laslett, Cambridge University Press, (1967).
48. J. Macintosh, *Vindicae Gallicae. Defense of the French Revolution and its English Admirers against the Accusations of the Right Hon. Edmund Burke...*, Robinson, London, (1791).
49. J. Macintosh, *A Discourse on the Study of the Law of Nature and of Nations*, Caldell, London, (1799).
50. T. Paine, *The Rights of Man: being an Answer to Mr. Burke's Attack on The French Revolution*, Jordan, London, part I (1791), part II (1792).
51. H.G. Wells, *Anticipations of the Reaction of Mechanical and Scientific Progress on Human Life and Thought*, Chapman and Hall, London, (1902).
52. B. Wiley, *The Eighteenth Century Background: Studies of the Idea of Nature in the Thought of the Period*, Chatto and Windus, London, (1940).
53. G.R. Morrow, *The Ethical and Economic Theories of Adam Smith: A Study in the Social Philosophy of the 18th Century*, Cornell Studies in Philosophy, **13**, 91-107, (1923).
54. H.W. Schneider, ed., *Adam Smith's Moral and Political Philosophy*, Harper Torchbook edition, New York, (1948).
55. F. Rosen, *Classical Utilitarianism from Hume to Mill*, Routledge, (2003).
56. J.Z. Muller, *The Mind and the Market: Capitalism in Western Thought*, Anchor Books, (2002).
57. J.Z. Muller, *Adam Smith in His Time and Ours: Designing the Decent Society*, Princeton University Press, (1995).
58. S. Hollander, *The Economics of Adam Smith*, University of Toronto Press, (19773).
59. K. Haakonssen, *The Cambridge Companion to Adam Smith*, Cambridge University Press, (2006).
60. K. Haakonssen, *The Science of a Legeslator: The Natural Jurisprudence of David Hume and Adam Smith*, Cambridge University Press, (1981).

61. I. Hont and M. Ignatieff, *Wealth and Virtue: The Shaping of Political Economy in the Scottish Enlightenment*, Cambridge University Press, (1983).
62. I.S. Ross, *The Life of Adam Smith*, Clarendon Press, Oxford, (1976).
63. D. Winch, *Adam Smith's Politics: An Essay in Historiographic Revision*, Cambridge University Press, (1979).
64. King, M., and Elliott, C. (1993). *Legitimate Double-Think*. *Lancet* 341:669-672.
65. Sen, A. (1989). *On Ethics and Economics*. Oxford, UK: Blackwell.
66. Worldwatch Institute (1987). *State of the World 1987*. Washington, DC: Worldwatch Institute.
67. United Nations, Department of Economic and Social Affairs, Population Division (2013) *World Population Prospects: The 2012 Revision*. (United Nations, New York).
68. Campbell, M., Cleland, J., Ezech, A. and Prata, N. (2007) *Return of the Population Growth Factor*. *Science* 315: 1501-1502
69. Coale, A.J. and Hoover, E.M. 1958. *Population growth and economic development in low-income countries*. Princeton University Press, New Jersey USA.
70. Friedman, T.L. (2013) *Tell me how this ends*. *New York Times*, 21 May 2013.
71. George, S. (2010) *Whose crisis, whose future?*, Polity Press, Cambridge.
72. Kirk, D. (1996) *Demographic Transition Theory*. *Population Studies* 50(3): 361-387.
73. Lagi, M., Bertrand, K.Z., Bar-Yam, Y. (2011) *The food crises and political instability in North Africa and the Middle East*. New England Complex Systems Institute
74. P.R. Ehrlich and A.H. Ehrlich, *One With Nineveh: Politics, Consumption and the Human Future*, Island Press, (2004).
75. D.H. Meadows, D.L. Meadows, J. Randers, and W.W. Behrens III, *The Limits to Growth: A Report for the Club of Rome's Project on the Predicament of Mankind*, Universe Books, New York, (1972).
76. D.H. Meadows et al., *Beyond the Limits. Confronting Global Collapse and Envisioning a Sustainable Future*, Chelsea Green Publishing, Post Mills, Vermont, (1992).
77. D.H. Meadows, J. Randers and D.L. Meadows, *Limits to Growth: the 30-Year Update*, Chelsea Green Publishing, White River Jct., VT 05001, (2004).
78. A. Peccei and D. Ikeda, *Before it is Too Late*, Kodansha International, Tokyo, (1984).
79. V.K. Smith, ed., *Scarcity and Growth Reconsidered*, Johns Hopkins University Press, Baltimore, (1979).
80. British Petroleum, *BP Statistical Review of World Energy*, (published yearly).
81. R. Costanza, ed., *Ecological Economics: The Science and Management of Sustainability*, Columbia University Press, New York, (1991).
82. J. Darmstadter, *A Global Energy Perspective*, Sustainable Development Issue Backgrounder, Resources for the Future, (2002).
83. D.C. Hall and J.V. Hall, *Concepts and Measures of Natural Resource Scarcity*, *Journal of Environmental Economics and Management*, **11**, 363-379, (1984).
84. M.K. Hubbert, *Energy Resources*, in *Resources and Man: A Study and Recommendations*, Committee on Resources and Man, National Academy of Sciences, National Research Council, W.H. Freeman, San Francisco, (1969).

85. J.A. Krautkraemer, *Nonrenewable Resource Scarcity*, *Journal of Economic Literature*, bf 36, 2065-2107, (1998).
86. C.J. Cleveland, *Physical and Economic Aspects of Natural Resource Scarcity: The Cost of Oil Supply in the Lower 48 United States 1936-1987*, *Resources and Energy* **13**, 163-188, (1991).
87. C.J. Cleveland, *Yield Per Effort for Additions to Crude Oil Reserves in the Lower 48 States, 1946-1989*, *American Association of Petroleum Geologists Bulletin*, **76**, 948-958, (1992).
88. M.K. Hubbert, *Technique of Prediction as Applied to the Production of Oil and Gas*, in *NBS Special Publication 631*, US Department of Commerce, National Bureau of Standards, (1982).
89. L.F. Ivanhoe, *Oil Discovery Indices and Projected Discoveries*, *Oil and Gas Journal*, **11**, 19, (1984).
90. L.F. Ivanhoe, *Future Crude Oil Supplies and Prices*, *Oil and Gas Journal*, July 25, 111-112, (1988).
91. L.F. Ivanhoe, *Updated Hubbert Curves Analyze World Oil Supply*, *World Oil*, November, 91-94, (1996).
92. L.F. Ivanhoe, *Get Ready for Another Oil Shock!*, *The Futurist*, January-February, 20-23, (1997).
93. Energy Information Administration, *International Energy Outlook, 2001*, US Department of Energy, (2001).
94. Energy Information Administration, *Caspian Sea Region*, US Department of Energy, (2001).
95. National Energy Policy Development Group, *National Energy Policy*, The White House, (2004). (<http://www.whitehouse.gov/energy/>)
96. IEA, *CO₂ from Fuel Combustion Fact-Sheet*, International Energy Agency, (2005).
97. H. Youguo, *China's Coal Demand Outlook for 2020 and Analysis of Coal Supply Capacity*, International Energy Agency, (2003).
98. R.H. Williams, *Advanced Energy Supply Technologies*, in *World Energy Assessment: Energy and the Challenge of Sustainability*, UNDP, (2000).
99. H. Lehmann, *Energy Rich Japan*, Institute for Sustainable Solutions and Innovations, Aachen, (2003).
100. W.V. Chandler, *Materials Recycling: The Virtue of Necessity*, Worldwatch Paper 56, Worldwatch Institute, Washington D.C, (1983).
101. W.C. Clark and others, *Managing Planet Earth*, Special Issue, *Scientific American*, September, (1989).
102. B. Commoner, *The Closing Circle: Nature, Man and Technology*, Bantam Books, New York, (1972).
103. J.R. Frisch, *Energy 2000-2020: World Prospects and Regional Stresses*, World Energy Conference, Graham and Trotman, (1983).
104. J. Holdren and P. Herrera, *Energy*, Sierra Club Books, New York, (1971).
105. National Academy of Sciences, *Energy and Climate*, NAS, Washington D.C., (1977).

106. W. Ophuls, *Ecology and the Politics of Scarcity*, W.H. Freeman, San Francisco, (1977).
107. C. Pollock, *Mining Urban Wastes: The Potential for Recycling*, Worldwatch Paper 76, Worldwatch Institute, Washington D.C., (1987).
108. World Resources Institute, *World Resources*, Oxford University Press, New York, (published annually).
109. World Resources Institute, *World Resources 2000-2001: People and Ecosystems: The Fraying Web of Life*, WRI, Washington D.C., (2000).
110. J.E. Young, John E., *Mining the Earth*, Worldwatch Paper 109, Worldwatch Institute, Washington D.C., (1992).
111. J.R. Craig, D.J. Vaughan and B.J. Skinner, *Resources of the Earth: Origin, Use and Environmental Impact, Third Edition*, Prentice Hall, (2001).
112. W. Youngquist, *Geodesinies: The Inevitable Control of Earth Resources Over Nations and Individuals*, National Book Company, Portland Oregon, (1997).
113. M. Tanzer, *The Race for Resources. Continuing Struggles Over Minerals and Fuels*, Monthly Review Press, New York, (1980).
114. C.B. Reed, *Fuels, Minerals and Human Survival*, Ann Arbor Science Publishers Inc., Ann Arbor Michigan, (1975).
115. M.K. Hubbert, *Energy Resources*, in *Resources and Man: A Study and Recommendations*, Committee on Resources and Man, National Academy of Sciences, National Research Council, W.H. Freeman, San Francisco, (1969).
116. J.A. Krautkraemer, *Nonrenewable Resource Scarcity*, *Journal of Economic Literature*, bf 36, 2065-2107, (1998).
117. C.J. Cleveland, *Physical and Economic Aspects of Natural Resource Scarcity: The Cost of Oil Supply in the Lower 48 United States 1936-1987*, *Resources and Energy* **13**, 163-188, (1991).
118. C.J. Cleveland, *Yield Per Effort for Additions to Crude Oil Reserves in the Lower 48 States, 1946-1989*, *American Association of Petroleum Geologists Bulletin*, **76**, 948-958, (1992).
119. M.K. Hubbert, *Technique of Prediction as Applied to the Production of Oil and Gas*, in *NBS Special Publication 631*, US Department of Commerce, National Bureau of Standards, (1982).
120. Energy Information Administration, *International Energy Outlook, 2001*, US Department of Energy, (2001).
121. Energy Information Administration, *Caspian Sea Region*, US Department of Energy, (2001).
122. National Energy Policy Development Group, *National Energy Policy*, The White House, (2004). (<http://www.whitehouse.gov/energy/>)
123. M. Klare, *Bush-Cheney Energy Strategy: Procuring the Rest of the World's Oil*, *Foreign Policy in Focus*, (Interhemispheric Resource Center/Institute for Policy Studies/SEEN), Washington DC and Silver City NM, January, (2004).
124. IEA, *CO2 from Fuel Combustion Fact-Sheet*, International Energy Agency, (2005).

125. H. Youguo, *China's Coal Demand Outlook for 2020 and Analysis of Coal Supply Capacity*, International Energy Agency, (2003).
126. R.H. Williams, *Advanced Energy Supply Technologies*, in *World Energy Assessment: Energy and the Challenge of Sustainability*, UNDP, (2000).
127. H. Lehmann, *Energy Rich Japan*, Institute for Sustainable Solutions and Innovations, Achen, (2003).
128. W.V. Chandler, *Materials Recycling: The Virtue of Necessity*, Worldwatch Paper 56, Worldwatch Institute, Washington D.C, (1983).
129. J.R. Frisch, *Energy 2000-2020: World Prospects and Regional Stresses*, World Energy Conference, Graham and Trotman, (1983).
130. J. Gever, R. Kaufmann, D. Skole and C. Vorosmarty, *Beyond Oil: The Threat to Food and Fuel in the Coming Decades*, Ballinger, Cambridge MA, (1986).
131. J. Holdren and P. Herrera, *Energy*, Sierra Club Books, New York, (1971).
132. National Academy of Sciences, *Energy and Climate*, NAS, Washington D.C., (1977).
133. W. Ophuls, *Ecology and the Politics of Scarcity*, W.H. Freeman, San Francisco, (1977).
134. P.B. Smith, J.D. Schilling and A.P. Haines, *Introduction and Summary*, in *Draft Report of the Pugwash Study Group: The World at the Crossroads*, Berlin, (1992).
135. World Resources Institute, *World Resources*, Oxford University Press, New York, (published annually).
136. J.R. Craig, D.J. Vaughan and B.J. Skinner, *Resources of the Earth: Origin, Use and Environmental Impact, Third Edition*, Prentice Hall, (2001).
137. W. Youngquist, *Geodesinies: The Inevitable Control of Earth Resources Over Nations and Individuals*, National Book Company, Portland Oregon, (1997).
138. M. Tanzer, *The Race for Resources. Continuing Struggles Over Minerals and Fuels*, Monthly Review Press, New York, (1980).
139. C.B. Reed, *Fuels, Minerals and Human Survival*, Ann Arbor Science Publishers Inc., Ann Arbor Michigan, (1975).
140. A.A. Bartlett, *Forgotten Fundamentals of the Energy Crisis*, American Journal of Physics, **46**, 876-888, (1978).

Chapter 11

DISEASE TODAY

11.1 Jenner

If the Europeans and Americans of the 19th century felt that their scientific civilization had something to offer to humanity as a whole, they may have had in mind not only factories, steamships, railways and telegraphs, but also great victories won against disease. The first of these victories was won against smallpox, a disease which at one time was so common that almost everyone was sure of getting it. In the more severe epidemics, one person out of three who contracted smallpox died of the disease. Those who recovered were often so severely disfigured that their faces were hardly human.

Since smallpox was so common that people scarcely hoped to avoid it entirely, they hoped instead to have a mild case. It had been noticed that anyone who survived an attack of smallpox could never be attacked again. In Turkey and China, people sometimes inoculated themselves with pus taken from the blisters of patients sick with smallpox in a mild form. The Turkish and Chinese custom of inoculation was introduced into Europe in the 18th century, and Diderot, the editor of the Encyclopedia, did much to make this practice popular. However, this type of inoculation was dangerous: It gave protection against future attacks, but often the inoculated person became severely ill or died. It was like “Russian roulette”.

The story of safe immunization against smallpox began when an English physician named Edward Jenner (1749-1823) treated a dairymaid. He suspected that she might have smallpox; but when he told her this, she replied: “I cannot take the smallpox sir, because I have had the cowpox”. She told him that it was common knowledge among the people of her district that anyone who had been ill with cowpox (a mild disease of cattle which sometimes affected farmers and dairymaids), would never be attacked by smallpox.

Jenner realized that if her story were true, it might offer humanity a safe method of immunization against one of its most feared diseases. On May 14, 1796, he found a dairymaid with active cowpox, and taking a little fluid from a blister on her hand, he injected it into a boy. The boy became ill with cowpox, but he recovered quickly, because the disease is always mild.

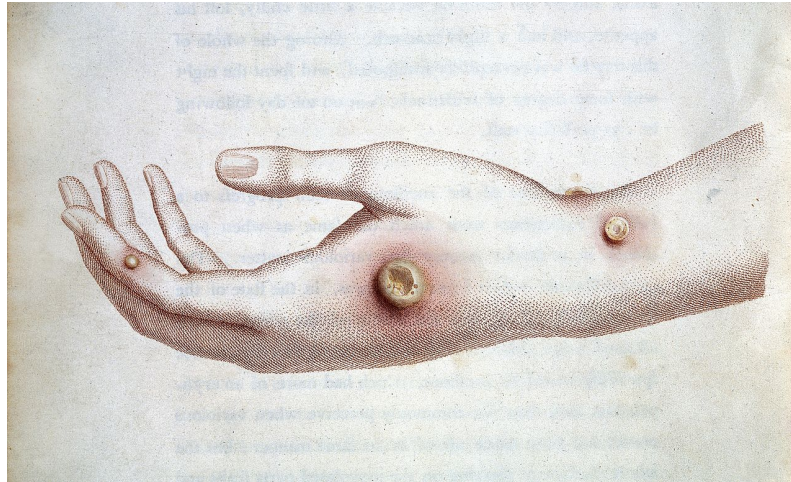

Figure 11.1: **The hand of Sarah Nelmes infected with the cowpox.** Wellcome Images, [CC BY 4.0], Wikimedia Commons

Jenner then took the dangerous step of inoculating the boy with smallpox. If the boy had died, Jenner would have been a criminal - but he was immune! It took Jenner two years to find the courage and the opportunity to try the experiment again; but when he repeated it in 1798 with the same result, he decided to publish his findings.

So great was the terror of smallpox, that Jenner was immediately besieged with requests for immunization by inoculation with cowpox (which he called “vaccination” after *vacca*, the Latin word for “cow”). The practice quickly became accepted: The English Royal Family was vaccinated, and Parliament voted Jenner rewards totalling thirty thousand pounds - in those days an enormous sum.

In 1807, Bavaria made vaccination compulsory, and celebrated Jenner’s birthday as a holiday. Russia also enthusiastically adopted vaccination. The first child in Russia to be vaccinated was given the name “Vaccinov”, and was educated at the expense of the state. Thanks to Jenner and the dairymaid, smallpox began to disappear from the earth.



Figure 11.2: Edward Jenner. Pastel by John Raphael Smith. Edward Jenner pioneered vaccination against smallpox using the cowpox vaccine.

11.2 Pasteur

In 1800, when vaccination began to be used against smallpox, no one understood why it worked. No one, in fact, understood what caused infectious diseases. It had been more than a century since Anton van Leewenhoek had studied bacteria with his home-made microscopes and described them in long letters to the Royal Society. However, the great Swedish naturalist, Carolus Linnaeus, left microscopic organisms out of his classification of all living things on the grounds that they were too insignificant and chaotic to be mentioned.

This was the situation when Louis Pasteur was born in 1822, in the Jura region of France, near the Swiss border. His father was a tanner in the small town of Arbois. Pasteur's parents were not at all rich, but they were very sincere and idealistic, and they hoped that their son would one day become a teacher.

As a boy, Louis Pasteur was considered to be a rather slow student, but he was artistically gifted. Between the ages of 13 and 19, he made many realistic and forceful portraits of the people of his town. His ambition was to become a professor of the fine arts; and with this idea he studied to qualify for the entrance examination of the famous *École Normale* of Paris, supporting himself with a part-time teaching job, and sometimes enduring semi-starvation when the money sent by his father ran out.

The earnest, industrious and artistically gifted boy would certainly have succeeded in becoming an excellent professor of the fine arts if he had not suddenly changed his mind and started on another path. This new path was destined to win Louis Pasteur a place among the greatest benefactors of humanity.

The change came when Pasteur attended some lectures by the famous chemist Jean Baptiste Dumas. Professor Dumas was not only a distinguished researcher; he was also a spellbinding speaker, whose lectures were always attended by six or seven hundred excited students. "I have to go early to get a place", Pasteur wrote to his parents, "just as in the theatre". Inspired by these lectures, Pasteur decided to become a chemist. He put away his brushes, and never painted again.

While he was still a student, Pasteur attracted the attention of Antoine Jerome Balard, the discoverer of the element bromine. Instead of being sent to teach at a high-school in the provinces after his graduation, Pasteur became an assistant in the laboratory of Balard, where he had a chance to work on a doctor's degree, and where he could talk with the best chemists in Paris. Almost every Thursday, he was invited to the home of Professor Dumas, where the conversation was always about science.

Pasteur's first important discovery came when he was 25. He had been studying the tartarates - a group of salts derived from tartaric acid. There was a mystery connected with these salts because, when polarized light was passed through them, they rotated the direction of polarization. On the other hand, paratartaric acid (now called racemic acid), did not exhibit this effect at all, nor did its salts. This was a mystery, because there seemed to be no chemical difference between tartaric acid and racemic acid.

Studying tiny crystals of paratartaric acid under his microscope, Pasteur noticed that there were two kinds, which seemed to be mirror images of one another. His vivid imagi-

nation leaped to the conclusion that the two types of crystals were composed of different forms of tartaric acid, the molecules of one form being mirror images of the other. Therefore the crystals too were mirror images, since, as Pasteur guessed, the shapes of the crystals resulted from the shapes of the molecules.

By painstakingly separating the tiny right-handed crystals from the left-handed ones, Pasteur obtained a pure solution of right-handed molecules, and this solution rotated polarized light. The left-handed crystals, when dissolved, produced the opposite rotation! Pasteur ran from the laboratory, embraced the first person that he met in the hall, and exclaimed: "I have just made a great discovery! I am so happy that I am shaking all over, and I am unable to set my eyes again to the polarimeter."

Jean Baptiste Biot, the founder of the field of polarimetry, was sceptical when he heard of Pasteur's results; and he asked the young man to repeat the experiments so that he could see the results with his own eyes. Under Biot's careful supervision, Pasteur separated the two types of crystals of racemic acid, and put a solution of the left-handed crystals into the polarimeter.

"At the first sight of the color tints presented by the two halves of the field", Pasteur wrote, "and without having to make a reading, Biot recognized that there was a strong rotation to the left. Then the illustrious old man, who was visibly moved, seized me by the hand and said: 'My dear son, all my life I have loved science so deeply that this stirs my heart!'"

As he continued his work with right- and left-handed molecules, Pasteur felt that he was coming close to an understanding of the mysteries of life itself, since, as Biot had shown, the molecules which rotate polarized light are almost exclusively molecules produced by living organisms. He soon discovered that he could make an optically active solution of tartaric acid in another way: When he let the mould *penicillium glaucum* grow in a solution of racemic acid, the left-handed form disappeared, and only the right-handed form remained. In this way, Pasteur became interested in the metabolism of microscopic organisms.

Pasteur's work on crystallography and optical activity had made him famous among chemists, and he was appointed Professor of Chemistry at the University of Strasbourg. He soon fell in love with and married the daughter of the Rector of the university, Marie Laurent. This marriage was very fortunate for Pasteur. In the words of Pasteur's assistant, Emil Roux, "Madame Pasteur loved her husband to the extent of understanding his studies... She was more than an incomparable companion for her husband: She was his best collaborator". She helped him in every way that she could - protecting him from everyday worries, taking dictation, copying his scientific papers in her beautiful handwriting, discussing his experiments and asking intelligent questions which helped him to clarify his thoughts.

After a few years at Strasbourg, Pasteur was appointed Dean of the Faculty of Sciences at the University of Lille. In appointing him, the French government explained to Pasteur that they expected him to place the Faculty of Sciences of the university at the service of the industry and agriculture of the district.

Pasteur took this commission seriously, and he soon put his studies of microorganisms to good use in the service of a local industry which produced alcohol from beet juice. He

was able to show that whenever the vats of juice contained bacteria, they spoiled; and he showed the local manufacturers how eliminate harmful bacteria from their vats. As a result of this work, the industry was saved.

His work on fermentation put Pasteur into conflict with the opinions of the most famous chemists of his time. He believed that it was the action of the living yeast cells which turned sugar into alcohol, since he had observed that the yeasts were alive and that the amount of alcohol produced was directly proportional to the number of yeasts present. On the other hand, the Swedish chemist, Jöns Jakob Berzelius (1779-1848), had considered fermentation to be an example of catalysis, while Justus von Liebig (1805-1875) thought that the yeasts were decaying during fermentation, and that the breakdown of the yeast cells somehow assisted the conversion of sugar to alcohol. (Both Pasteur and Berzelius were right! Although the fermentation observed by Pasteur was an example of the action of living yeasts, it is possible to extract an enzyme from the yeasts which can convert sugar to alcohol without the presence of living cells.)

Pasteur studied other fermentation processes, such as the conversion of sugar into lactic acid by the bacilli which are found in sour milk, and the fermentation which produces butyric acid in rancid butter. He discovered that each species of microorganism produces its own specific type of fermentation; and he learned to grow pure cultures of each species.

At the suggestion of Napoleon III, Pasteur turned his attention to the French wine industry, which was in serious difficulties. He began to look for ways to get rid of the harmful bacteria which were causing spoilage of the wine. After trying antiseptics, and finding them unsatisfactory, Pasteur finally found a method for killing the bacteria, without affecting the taste of the wine, by heating it for several minutes to a temperature between 50 and 60 degrees centigrade. This process ("Pasteurization") came to be applied, not only to wine, but also to milk, cheese, butter, beer and many other kinds of food.

Pasteur developed special machines for heat-treating large volumes of liquids. He patented these, to keep anyone else from patenting them, but he made all his patents available to the general public, and refused to make any money from his invention of the Pasteurization process. He followed the same procedure in patenting an improved process for making vinegar, but refusing to accept money for it.

Pasteur was now famous, not only in the world of chemists and biologists, but also in the larger world. He was elected to membership by the French Academy of Sciences, and he was awarded a prize by the Academy for his research refuting the doctrine of spontaneous generation.

11.3 The germ theory of disease

In 1873, Louis Pasteur was elected to membership by the French Academy of Medicine. Many conservative physicians felt that he had no right to be there, since he was really a chemist, and had no medical "union card". However, some of the younger doctors recognized Pasteur as the leader of the most important revolution in medical history; and a young physician, Emil Roux, became one of Pasteur's devoted assistants.

When he entered the Academy of Medicine, Pasteur found himself in the middle of a heated debate over the germ theory of disease. According to Pasteur, every contagious disease is caused by a specific type of microorganism. To each specific disease there corresponds a specific germ.

Pasteur was not alone in advocating the germ theory, nor was he the first person to propose it. For example, Varro (117 B.C. - 26 B.C.), believed that diseases are caused by tiny animals, too small to be seen, which are carried by the air, and which enter the body through the mouth and nose.

In 1840, Jacob Henle, a distinguished Bavarian anatomist, had pointed out in an especially clear way what one has to do in order to prove that a particular kind of germ causes a particular disease: The microorganism must be found consistently in the diseased tissue; it must be isolated from the tissue and cultured; and it must then be able to induce the disease consistently. Finally, the newly-diseased animal or human must yield microorganisms of the same type as those found originally.

Henle's student, Robert Koch (1843-1910), brilliantly carried out his teacher's suggestion. In 1872, Koch used Henle's method to prove that anthrax is due to rodlike bacilli in the blood of the infected animal. Koch's pioneering contributions to microbiology and medicine were almost as great as those of Pasteur. Besides being the first person to prove beyond doubt that a specific disease was caused by a specific microorganism, Koch introduced a number of brilliant technical improvements which paved the way for rapid progress in bacteriology and medicine.

Instead of using liquids as culture media, Koch and his assistant, Petri, pioneered the use of solid media. Koch developed a type of gel made from agar-agar (a substance derived from seaweed). On the surface of this gel, bacteria grew in tiny spots. Since the bacteria could not move about on the solid surface, each spot represented a pure colony of a single species, derived from a single parent. Koch also pioneered techniques for staining bacteria, and he introduced the use of photography in bacteriology. He was later to isolate the bacillus which causes tuberculosis, and also the germ which causes cholera.

When Koch's work was attacked in the French Academy of Medicine, Pasteur rushed to his defense. In order to demonstrate that it was living bacilli in the blood of a sheep with anthrax which transmitted the disease, and not something else in the blood, Pasteur took a drop of infected blood and added it to a large flask full of culture medium. He let this stand until the bacteria had multiplied; and then he took a tiny drop from the flask and transferred it to a second flask of nutrient broth. He did this a hundred times, so that there was no possibility that anything whatever remained from the original drop of sheep's blood. Nevertheless, a tiny amount of liquid from the hundredth flask was just as lethal as fresh blood drawn from a sheep with anthrax.

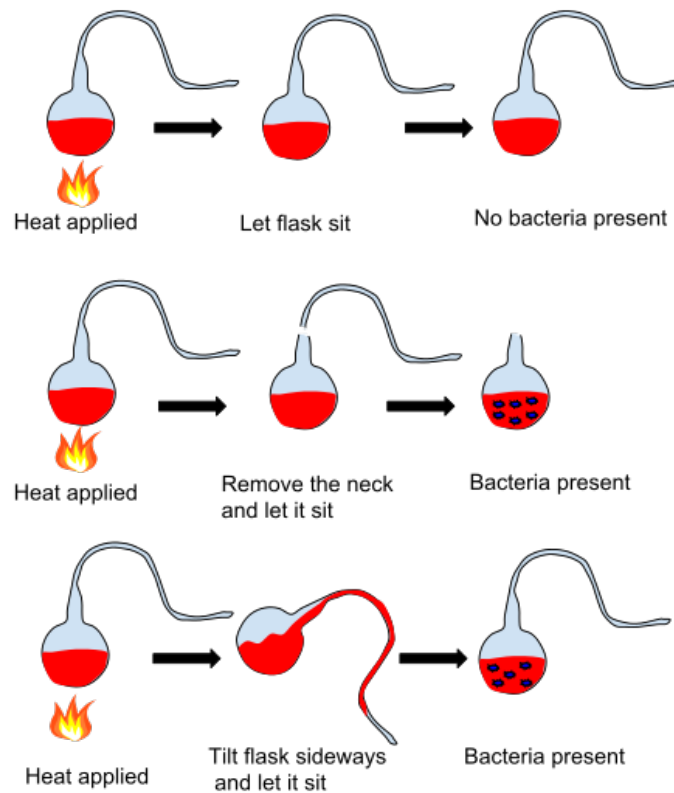

Figure 11.3: Louis Pasteur's pasteurization experiment illustrates the fact that the spoilage of the liquid was caused by particles in the air rather than than the air itself. These experiments were important pieces of evidence supporting the idea of Germ Theory of Disease.

11.4 Vaccines

Pasteur read and reread the papers of Jenner on immunization against smallpox. He searched continually for something analogous to smallpox vaccination which could be applied to other diseases. Finally, the answer came by chance.

Pasteur and his assistants had been studying chicken cholera, an invariably fatal disease of chickens. Roux and Chamberland were carrying out a series of experiments where they made a fresh culture of chicken cholera bacteria every day. When they injected a bit of liquid from any of these cultures into a chicken, the chicken always died.

It was summer, and the young men went off for two weeks of vacation. When they came back, they took their two-week-old culture of chicken cholera out of the cupboard and injected it into a hen; but the hen didn't die. They decided that while they had been on vacation, the culture must have lost its strength; and after some effort, they obtained a new specimen of active chicken cholera bacteria, which they injected into their hens. All the hens died except one. The hen which had previously been inoculated with two-week-old culture didn't even get sick!

When Pasteur returned to his laboratory, the two young men hesitated to tell him about this strange result because they were afraid that he might be angry with them for going off on a holiday and breaking off the series of experiments. However, they finally confessed what had happened, and added the strange detail about the chicken which had not died. In the middle of their apologies, Pasteur raised his hand. "Please be quiet for a moment", he said, "I want to think". After a few moments of silence, Pasteur looked at Roux and Chamberland and said, "That's it! The hen that didn't die was *vaccinated* by the old culture!"

This was the big breakthrough - a turning point in medical history. Pasteur, Roux and Chamberland had discovered by chance a method of weakening a culture of bacteria so that it would not produce the fatal disease with which it was usually associated; but on the other hand, it was still able to alert the body's defense mechanisms, so that the inoculated animal became immune. This great discovery was made by chance, but, as Pasteur was fond of saying, "In research, chance favors the prepared mind".

Pasteur, Roux and Chamberland dropped everything else and began a series of experiments to find the best way of weakening their cultures of chicken cholera. They found that the critical factor was the proper amount of exposure to air. (Probably the culture contained a few mutant bacteria, able to grow well in air, but not able to produce chicken cholera; and during the exposure of a culture, these mutants multiplied rapidly, until the entire population was composed of mutants.)

Pasteur now began research on a vaccine against anthrax - a disease which was causing serious economic loss to farmers, and which could affect humans as well as animals. With anthrax, the problem was to keep the bacilli from forming spores. After much experimentation, the group found that if they held their anthrax cultures at a temperature between 42 C and 43 C, the bacilli would still grow, but they did not form spores.

Pasteur and his coworkers allowed their cultures to grow at 42 C in shallow dishes, where there was good contact with the air. They found that after two weeks, the cultures



Figure 11.4: **Photograph of Louis Pasteur.**

were weakened to the point where they would make a sheep sick, but not kill it. They developed a method for inoculating animals in two stages - first with a very much weakened culture, and later with a stronger one. After the second inoculation, the animals could stand an injection of even the most virulent anthrax bacilli without becoming ill.

When Pasteur published these results, there was much sarcasm among veterinarians. The editor of the *Veterinary Press*, a surgeon named Rossignol, wrote: "Monsieur Pasteur's discovery, *if it were genuine*, should not be kept in the laboratory". Rossignol proposed a public trial of the anthrax vaccine, and he started a campaign to collect money for the purchase of experimental animals.

Pasteur's friends warned him against accepting the risk of a public trial at such an early stage. He had not tested his vaccine sufficiently, and a failure would make him the laughing stock of Europe. However, Pasteur saw the trial as a chance to focus public attention on microorganisms and vaccines. Like Galileo, Pasteur had a flair for dramatic gestures and public debate; and the impact of his career was greatly enhanced by his ability to attract widespread attention.

A farm near Melun called Pouilly le Fort was chosen as the site for the experiment; and sixty sheep, together with several cows, were put at Pasteur's disposal. Thousands of people made the journey from Paris to Melun to watch the first injections, which were made on May 5, 1881. Twelve days later, the same sheep were inoculated with a stronger vaccine. Then, on May 31, the big test was made - both the vaccinated and unvaccinated animals were inoculated with a highly lethal culture of anthrax. Pasteur went back to Paris. There was nothing to do but wait.

The next afternoon, a telegram from Rossignol shattered Pasteur's confidence: It said that one of the vaccinated sheep was dying. Pasteur spent a sleepless night. The following morning, however, at nine o'clock, another telegram arrived from Rossignol: All the vaccinated sheep were well, even the one which had seemed to be dying; and all the unvaccinated sheep were either dying or already dead! Rossignol, who had been Pasteur's enemy, was completely converted; and his telegram ended with the words, "Stunning success!" When the aging Pasteur limped onto the field at Pouilly le Fort that afternoon, a great cheer went up from the thousands of people present.

11.5 Rabies

The next disease which Pasteur attempted to conquer was rabies, the terrifying and invariably fatal disease which often follows the bite of a mad dog. The rabies virus travels slowly through the body from the wounds to the spinal cord, where, after one or two months, it attacks the nervous system. If a victim is offered water and attempts to swallow, his head jerks back in terrible spasms, which make rabies extremely frightening, both for the victim and for the onlooker. For this reason, the disease is sometimes called hydrophobia - fear of water.

Pasteur and his coworkers soon discovered that even with their best microscopes, they were unable to see the organism which causes rabies. In fact, the disease is caused by a

virus, much too small to be seen with an optical microscope. Thus the aging Pasteur was confronted with an entirely new technical problem, never before encountered in microbiology.

He soon found that it was impossible to culture the rabies virus in a flask or dish, as he was in the habit of doing with bacteria. Absorbed in his research, he forgot his wedding anniversary. Marie Pasteur, however, remembered; and she wrote in a letter to her daughter:

“Your father is absorbed in his thoughts. He talks little, sleeps little, rises at dawn, and in a word, continues the life which which I began with him this day thirty-five years ago.”

Besides being technically difficult, the work on rabies was also dangerous. When Pasteur, Roux and Chamberland took samples of saliva from the foaming jaws of mad dogs, they risked being bitten by accident and condemned to an agonizing death from the convulsions of rabies. Since they could not culture the rabies virus in a dish or a flask of nutrient fluid, they were forced to grow it inside the nervous systems of experimental animals. After four years of difficult and hazardous work, they finally succeeded in developing a vaccine against rabies.

In the method which finally proved successful, they took a section of spinal cord from a rabbit with rabies and exposed it to air inside a germproof bottle. If the section of spinal cord remained in the bottle for a long time, the culture was very much weakened or “attenuated”, while when it was exposed to air for a shorter time, it was less attenuated. As in the case of anthrax, Pasteur built up immunity by a series of injections, beginning with a very much attenuated culture, and progressing to more and more virulent cultures.

At last, Pasteur had a method which he believed could be used to save the lives of the victims of mad dogs and wolves; and he found himself faced with a moral dilemma: Everyone who developed rabies died of it; but not everyone who was bitten by a mad dog developed rabies. Therefore if Pasteur gave his vaccine to a human victim of a mad dog, he might harm someone who would have recovered without treatment.

He had published the results of his research, and he was inundated with requests for treatment, but still he hesitated. If he treated someone, and the person afterward died, he might be accused of murder; and all the work which he had done to build up public support for the new movement in medicine might be ruined.

Finally, on July 6, 1885, Pasteur’s indecision was ended by the sight of a man and woman who had come to him with their frightened nine-year-old son. The boy, whose name was Joseph Meitner, had been severely bitten by a mad dog. It was one thing to write letters refusing requests for treatment, and another thing to look at a doomed and frightened child and turn him away.

Pasteur felt that he had to help the boy. He consulted Alfred Vulpian, a specialist in rabies, and Vulpian assured him that Joseph Meitner had been bitten so severely that without treatment, he would certainly develop rabies and die. Pasteur also consulted Dr. Granchier, a young physician who had joined his staff, and together the three men agreed that there was no time to lose - they would have to begin inoculations immediately if they were to save the boy’s life. They decided to go ahead. To Pasteur’s great joy, Joseph



Figure 11.5: **The inoculation of Jean-Baptiste Jupille.** Public domain, **Wikimedia Commons**

Meitner remained completely well.

The second rabies victim to be treated by Pasteur was a fourteen-year-old Sheppard named Jupille. He had seen a mad dog about to attack a group of small children, and he had bravely fought with the maddened animal so that the children could escape. Finally he had managed to tie its jaws together, but his hands were so badly bitten that without treatment, he was certain to die. Like Joseph Meitner, Jupille was saved by the Pasteur treatment. A statue of Jupille in front of the Pasteur Institute commemorates his bravery.

Pasteur had now grown so old, and was so worn out by his labors that he could do no more. The task of winning a final victory over infectious diseases was not finished - it was barely begun; but at least the feet of researchers had been placed on the right road; and there were younger men and women enthusiastically taking up the task which Pasteur laid down.

On December 27, 1892, physicians and scientists from many countries assembled in

Paris to celebrate Pasteur's seventieth birthday. The old man was so weak that he was unable to reply in his own words to the address of Sir Joseph Lister and to the cheers of the crowd; but his words were read by his son. Pasteur spoke to the young men and women who would take his place in the fight against disease:

“Do not let yourselves be discouraged by the sadness of certain hours which pass over nations. Live in the serene peace of your laboratories and libraries. Say to yourselves first, ‘What have I done for my instruction?’, and as you gradually advance, ‘What have I done for my country?’, until the time comes when you may have the intense happiness of thinking that you have contributed in some way to the progress and good of humanity.”

11.6 How our immune systems work

The language of molecular complementarity

In living (and even non-living) systems, signals can be written and read at the molecular level. The language of molecular signals is a language of complementarity. The first scientist to call attention to complementarity and pattern recognition at the molecular level was Paul Ehrlich, who was born in 1854 in Upper Silesia (now a part of Poland). Ehrlich was not an especially good student, but his originality attracted the attention of his teacher, Professor Waldeyer, under whom he studied chemistry at the University of Strasbourg. Waldeyer encouraged him to do independent experiments with the newly-discovered aniline dyes; and on his own initiative, Ehrlich began to use these dyes to stain bacteria. He was still staining cells with aniline dyes a few years later (by this time he had become a medical student at the University of Breslau) when the great bacteriologist Robert Koch visited the laboratory. “This is young Ehrlich, who is very good at staining, but will never pass his examinations”, Koch was told. Nevertheless, Ehrlich did pass his examinations, and he went on to become a doctor of medicine at the University of Leipzig at the age of 24. His doctoral thesis dealt with the specificity of the aniline dyes: Each dye stained a special class of cell and left all other cells unstained.

Paul Ehrlich had discovered what might be called “the language of molecular complementarity”: He had noticed that each of his aniline dyes stained only a particular type of tissue or a particular species of bacteria. For example, when he injected one of his blue dyes into the ear of a rabbit, he found to his astonishment that the dye molecules attached themselves selectively to the nerve endings. Similarly, each of the three types of phagocytes could be stained with its own particular dye, which left the other two kinds unstained¹.

Ehrlich believed that this specificity came about because the side chains on his dye molecules contained groupings of atoms which were complementary to groups of atoms

¹ The specificity which Ehrlich observed in his staining studies made him hope that it might be possible to find chemicals which would attach themselves selectively to pathogenic bacteria in the blood stream and kill the bacteria without harming normal body cells. He later discovered safe cures for both sleeping sickness and syphilis, thus becoming the father of chemotherapy in medicine. He had already received the Nobel Prize for his studies of the mechanism of immunity, but after his discovery of a cure for syphilis, a street in Frankfurt was named after him!

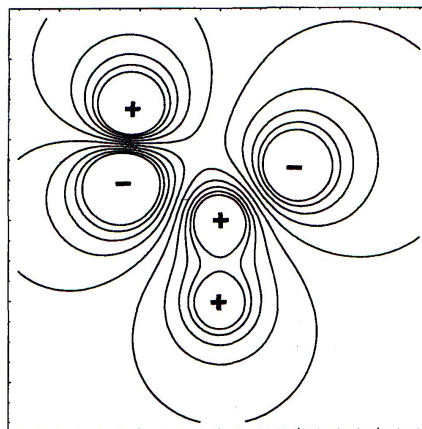

Figure 11.6: This figure shows the excess charges and the resulting electrostatic potential on a molecule of formic acid, HCOOH . The two oxygens in the carboxyl group are negatively charged, while the carbon and the two hydrogens have positive excess charges. Molecular recognition involves not only steric complementarity, but also complementarity of charge patterns.

on the surfaces of the cells or bacteria which they selectively stained. In other words, he believed that biological specificity results from a sort of lock and key mechanism: He visualized a dye molecule as moving about in solution until it finds a binding site which exactly fits the pattern of atoms in one of its side chains. Modern research has completely confirmed this picture, with the added insight that we now know that the complementarity of the “lock” and “key” is electrostatic as well as spatial.

Two molecules in a biological system may fit together because the contours of one are complementary to the contours of the other. This is how Paul Ehrlich visualized the fit - a spatial (steric) complementarity, like that of a lock and key. However, we now know that for maximum affinity, the patterns of excess charges on the surfaces of the two molecules must also be complementary. Regions of positive excess charge on the surface of one molecule must fit closely with regions of negative excess charge on the other if the two are to bind maximally. Thus the language of molecules is not only a language of contours, but also a language of charge distributions.

11.7 Paul Ehrlich, the father of chemotherapy

The first real understanding of the mechanism of the immune system was due to the work of Paul Ehrlich and Ilya Mechnikov, and in 1908 they shared a Nobel Prize for this work. Paul Ehrlich can be said to be the discoverer of biological specificity. As a young medical student at the University of Strasbourg, he was fortunate to work under the distinguished chemist Heinrich von Waldeyer, who took a great interest in Ehrlich. Stimulated by Waldeyer, Ehrlich began to do experiments in which he prepared thin slices of various tissues for

microscopic examination by staining them with the newly discovered aniline dyes. During the last half of the 19th century, there was a great deal of interest in histological staining. It was during this period that Walther Flemming in Germany discovered chromosomes by staining them with special dyes, and Christian Gram in Denmark showed that bacteria can be classified into two types by staining methods. (We now call these two types “gram positive” and “gram negative”). During this same period, and while he was still a student, Paul Ehrlich made the important discovery that mammalian blood contains three different types of white cells which can be distinguished by staining.

Ehrlich's early work on staining made him famous, and it also gave him a set of theories which led him to his great discoveries in immunology and chemotherapy. According to Ehrlich's ideas, the color of the aniline dyes is due to the aniline ring. However, dyes used commercially must also adhere to fabrics, and this adherence, according to Ehrlich, is due to the specific structure of the side chains. If the pattern of atoms on a side chain is complementary to the pattern of atoms on the binding site, the dye will adhere, but otherwise not. Thus there is a “lock and key” mechanism, and for this reason dyes with specific side chains stain specific types of tissue.

In one of his experiments, Paul Ehrlich injected methylene blue into the ear of a living rabbit, and found that it stained only the nerve endings of the rabbit. Since the rabbit seemed to be unharmed by the treatment, the experiment suggested to Ehrlich that it might be possible to find antibacterial substances which could be safely injected into the bloodstream of a patient suffering from an infectious disease. Ehrlich hoped to find substances which would adhere selectively to the bacteria, while leaving the tissues of the patient untouched.

With the help of a large laboratory especially constructed for him in Frankfurt, the center of the German dye industry, Ehrlich began to screen thousands of modified dyes and other compounds. In this way he discovered trypan red, a chemical treatment for sleeping sickness, and arsphenamine, a drug which would cure syphilis. Ehrlich thus became the father of modern chemotherapy. His success pointed the way to Gerhard Domagk, who discovered the sulphonamide drugs in the 1930s, and to Fleming, Waksman, Dubos and others, who discovered the antibiotics.

Ehrlich believed that in the operation of the immune system, the body produces molecules which have a pattern of atoms complementary to patterns (antigens) on invading bacteria, and that these molecules (antibodies) in the blood stream kill the bacteria by adhering to them.



Figure 11.7: Paul Ehrlich (1854-1915). By the time that he developed a drug that could cure syphilis, he had already received the Nobel Prize for Physiology or Medicine, but to further honor Ehrlich, a street in Frankfurt was named after him



Figure 11.8: Dr. Paul Ehrlich and his assistant Dr. Sahachiro Hata. They worked together to find cures for many diseases.



Figure 11.9: A West German postage stamp (1954) commemorating Paul Ehrlich and Emil von Behring, who worked together at Robert Koch's suggestion, producing a drug that could cure diphtheria.

11.8 Mechnikov

Meanwhile, the Russian naturalist Ilya Mechnikov discovered another mechanism by which the immune system operates. While on vacation in Sicily, Mechnikov was studying the digestive process in starfish larvae. In order to do this, he introduced some particles of carmine into the larvae. The starfish larvae were completely transparent, and thus Mechnikov could look through his microscope and see what happened to the particles. He saw that they were enveloped and apparently digested by wandering amoebalike cells inside the starfish larvae. As he watched this process, it suddenly occurred to Mechnikov that our white cells might similarly envelop and digest bacteria, thus protecting us from infection. Describing this discovery, Mechnikov wrote in his diary: “I suddenly became a pathologist! Feeling that there was in this idea something of surpassing interest, I became so excited that I began striding up and down the room, and even went to the seashore to collect my thoughts.”

Mechnikov later named the white cells “phagocytes” (which means “eating cells”). He was able to show experimentally that phagocytosis (i.e., the envelopment and digestion of bacteria by phagocytes) is an important mechanism in immunity.

Mechnikov’s ideas were not immediately accepted. Wikipedia states that “His theory, that certain white blood cells could engulf and destroy harmful bodies such as bacteria, met with scepticism from leading specialists including Louis Pasteur, Behring and others. At the time, most bacteriologists believed that white blood cells ingested pathogens and then spread them further through the body. His major supporter was Rudolf Virchow, who published his research in his *Archiv für pathologische Anatomie und Physiologie und für klinische Medizin* (now called the Virchows Archiv). His discovery of these phagocytes ultimately won him the Nobel Prize in 1908.”

For a number of years, there were bitter arguments between those who thought that the immune system operates through phagocytosis, and those who thought that it operates through antibodies. Finally it was found that both mechanisms play a role. In phagocytosis, the bacterium will not be ingested by the phagocyte unless it is first studded with antibodies. Thus both Mechnikov and Ehrlich were proved to be right.

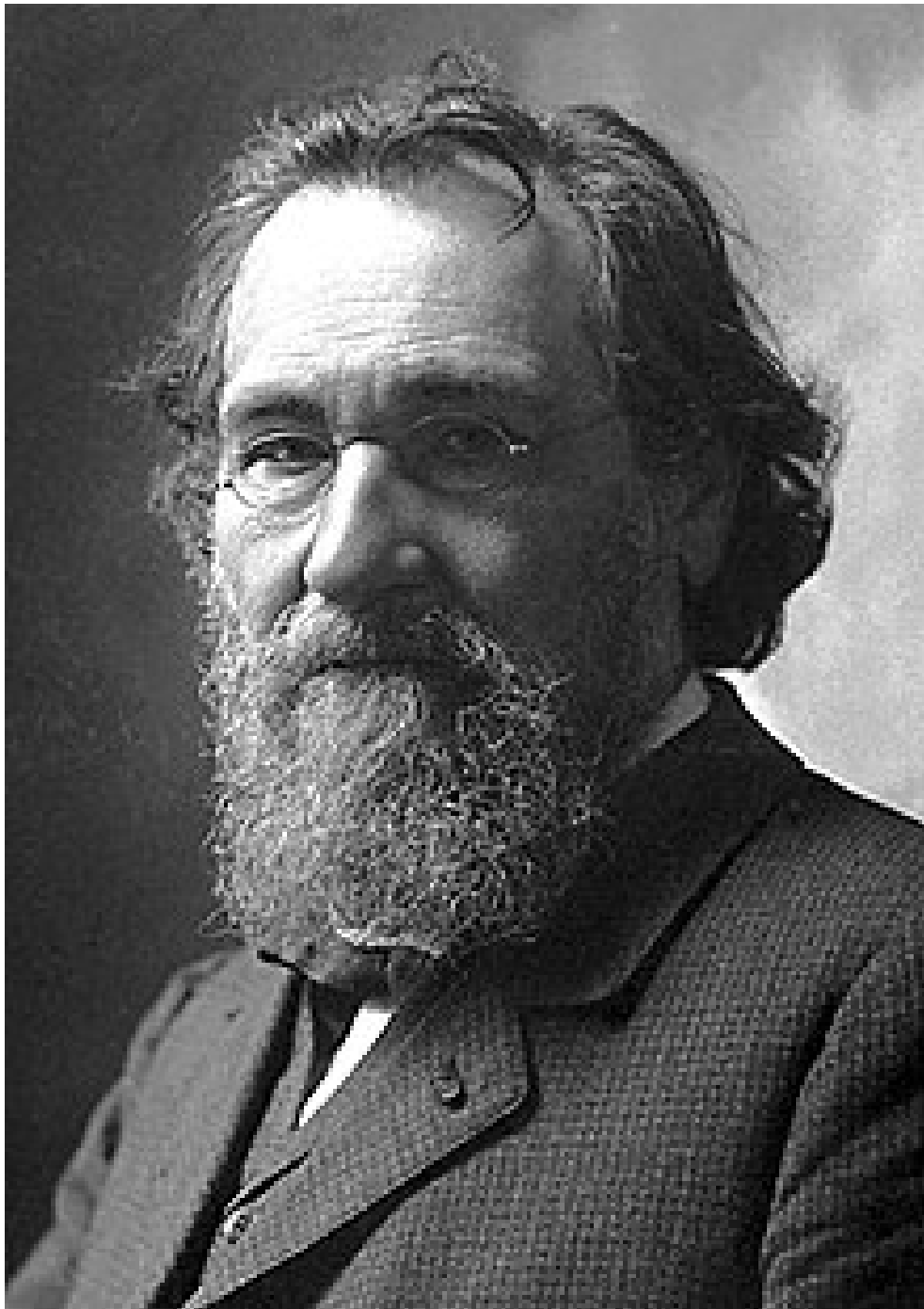

Figure 11.10: Ilya Mechnikov (1845-1916), sometimes spelled Élie Metchnikoff. He shared the 1908 Nobel Prize in Physiology or Medicine with Paul Ehrlich. Mechnikov has been called “the father of immunology” because of his discovery of phagocytosis.

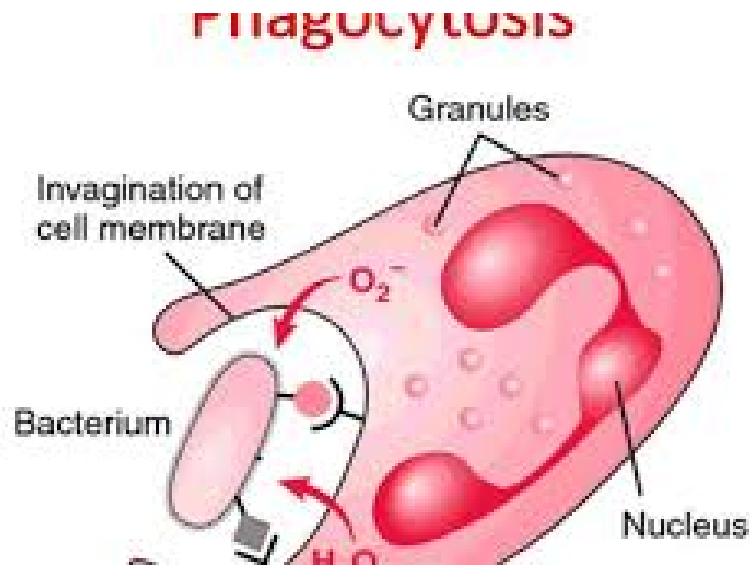

Figure 11.11: Phagocytosis: A lymphocyte “eats” a bacterium, but only if it is coated with the right antigens.

11.9 Burnet, Jerne and the clonal theory of immunity

As everyone knows, recovery from an infectious disease involves a response of our immune systems. Recovery occurs after the immune system has had some time to respond, and a recovered patient generally has some immunity to the disease.

During the 20th century, there were conflicting ideas about how and why this process occurs. One of these theories was proposed by Linus Pauling, who thought that an antigen on the surface of a bacteria or virus provides a template, and that the immune system uses this template to produce the specific antibodies needed to combat the disease. However, experimental evidence accumulated showing Pauling’s template theory to be wrong and supporting the clonal theory of immunity proposed by Sir Frank Macfarlane Burnet and Niels Kai Jerne.

According to the clonal theory of immunity, there are extremely many strains of lymphocytes, each of which produces a specific single antibody. Populations of all these many strains are always present in small numbers. When a patient becomes ill with an infection, the antigens of the ingesting bacteria or virus stimulate one specific strain of lymphocyte to reproduce itself in large numbers, i.e. to become a clone. This large population produces exactly the right antibodies needed to combat the disease, and the large population remains after recovery, conferring continued immunity.

In order for the immune system not to attack the cells of our own bodies, a learning process must take place, early in our lives, in which the difference between self and non-self is established, and the lymphocyte strains that attack self are suppressed. Jerne postulated (correctly) that this learning process takes place in the thymus gland, which is very large

in infants, and much smaller in adults.



Figure 11.12: Sir Frank Macfarlane Burnet (1899-1995). Both he and Niels Kai Jerne proposed the clonal theory of immunity.



Figure 11.13: The Danish immunologist Niels Kai Jerne (1911-1994). He shared the 1984 Nobel Prize for Physiology or Medicine with Georges Köhler and César Milstein “for theories concerning the specificity in development and control of the immune system and the discovery of the principle for production of monoclonal antibodies”.



Figure 11.14: Georges Köhler (1946-1995).



Figure 11.15: César Milstein (1927-2002).

11.10 Köhler, Milstein and monoclonal antibodies

Once the clonal theory of immunity became established, the way seemed open to clone *in vitro* B lymphocytes of a predetermined specificity. However, such clone cannot be made to live forever because like all other cells, except cancer cells, they are subject to “programed cell death”. To overcome this difficulty, Georges Köhler and César Milstein found a way to give the desired lymphocytes immortality by fusing them with myeloma cells, thus producing clones that could be cultured indefinitely.

The Wikipedia article on Monoclonal Antibodies states that “In the 1970s, the B-cell cancer multiple myeloma was known. It was understood that these cancerous B-cells all produce a single type of antibody (a paraprotein). This was used to study the structure of antibodies, but it was not yet possible to produce identical antibodies specific to a given antigen.

“In 1975, Georges Köhler and César Milstein succeeded in making fusions of myeloma cell lines with B cells to create hybridomas that could produce antibodies, specific to known antigens and that were immortalized. They and Niels Kaj Jerne shared the Nobel Prize in Physiology or Medicine in 1984 for the discovery.

“In 1988, Greg Winter and his team pioneered the techniques to humanize monoclonal antibodies, eliminating the reactions that many monoclonal antibodies caused in some patients.

“In 2018, James P. Allison and Tasuku Honjo received the Nobel Prize in Physiology or Medicine for their discovery of cancer therapy by inhibition of negative immune regulation, using monoclonal antibodies that prevent inhibitory linkages.”

11.11 History of the COVID-19 pandemic

Starting in December, 2019, and accelerating rapidly during the spring of 2020, our world has been hit by a new and extremely serious pandemic. It is caused by a coronavirus closely related to bat coronaviruses, and the disease, designated COVID-19 has a high death rate compared with seasonal influenza, as is shown below in Table 1. As of April 1, 2020, more than 859,000 cases of COVID-19 have been reported in over 200 countries and territories, resulting in approximately 42,000 deaths. Of course the death rate is actually lower than would be calculated from the ratio $42/859=0.049$, since the actual number of infected people is very much larger than the number of confirmed cases. Older people, and people with previously existing health problems are especially at risk.

The first cases of COVID-19 were noticed in the city of Wuhan, in the Hubei province of China. A cluster of cases centered on the Hunan Seafood Wholesale Market, and the outbreak is thought to have been a case where a virus has been transmitted from an animal host to humans.

The World Health Organization recognized the outbreak as being a Public Health Emergency of International Concern on January 30, 2020. Later, on March 11, 2020, WHO declared it to be a pandemic.

Governments around the world have reacted to the pandemic by closing borders, closing schools, universities, restaurants, barber shops, bars, sports events, and nonessential economic activities of all sorts, also requiring people to stay at home, and requesting them to practice “social distancing”, i.e. staying at least 2 meters from all others, even family members. Different countries have reacted with different rates of speed and different degrees of stringency. But the daily life of people around the world has been severely disrupted by the pandemic, and the economic consequences, already severe, will probably become worse.

A pandemic of this kind was not unexpected. Public health experts have been predicting that our world would soon be hit by a severe pandemic because air travel can take infected people almost instantly across vast distances, making local disease outbreaks global before effective limiting action can be taken.

We do not yet know how or when the COVID-19 pandemic will end. At present, there is no effective vaccine or treatment for the disease. My own belief is that monoclonal antibody techniques will be helpful in quickly developing antibodies for the treatment of the disease. For inexpensive mass-production of these antibodies, gene-splicing techniques may be helpful.

The COVID-19 pandemic has exposed many of the faults of the “status quo”, to which corporate oligarchs wish us to return after the epidemic has run its course. We must try to use the disaster as a way to return to something better than we had before. For example, the climate emergency must be adequately addressed. Our economic systems must also be reformed, so that they will work for the broad public good, rather than for the benefit of a small number of very wealthy people.

Table 11.1: Confirmed cases and deaths as of 31 March, 2020

| Country | cases | deaths |
|----------------|---------|--------|
| United States | 186,633 | 3,833 |
| Italy | 105,792 | 12,428 |
| Spain | 95,923 | 8,464 |
| China | 81,518 | 3,305 |
| Germany | 71,690 | 775 |
| France | 51,487 | 3,516 |
| Iran | 44,606 | 2,898 |
| United Kingdom | 25,150 | 1,808 |
| Switzerland | 16,597 | 432 |
| Turkey | 13,531 | 214 |
| Belgium | 12,775 | 705 |
| Netherlands | 12,595 | 1,039 |
| Austria | 10,088 | 128 |
| South Korea | 9,786 | 162 |
| Canada | 8,591 | 100 |
| Portugal | 7,443 | 160 |
| Brazil | 5,717 | 201 |

Table 11.2: **Confirmed cases and deaths as of 13 April, 2020**

| Country | cases | deaths |
|----------------|--------------|---------------|
| United States | 561,103 | 22,106 |
| Spain | 166,831 | 17,209 |
| Italy | 156,363 | 19,899 |
| Germany | 127,854 | 3,022 |
| France | 95,403 | 14,393 |
| United Kingdom | 84,279 | 10,612 |
| China | 82,160 | 3,341 |
| Iran | 71,686 | 4,474 |
| Turkey | 56,956 | 1,198 |
| Belgium | 29,647 | 3,600 |
| Netherlands | 25,587 | 2,737 |
| Switzerland | 25,398 | 1,103 |
| Canada | 24,366 | 718 |
| Brazil | 22,318 | 1,230 |
| Portugal | 16,585 | 504 |
| Russia | 15,770 | 130 |
| Austria | 13,945 | 350 |

Table 11.3: **Confirmed cases and deaths as of 24 June, 2020**

| Country | cases | deaths |
|----------------|--------------|---------------|
| United States | 2,391,336 | 122,985 |
| Brazil | 1,151,479 | 52,771 |
| Russia | 599,705 | 8,359 |
| India | 456,183 | 14,476 |
| United Kingdom | 306,210 | 42,927 |
| Peru | 260,810 | 8,404 |
| Chile | 250,767 | 4,505 |
| Spain | 246,752 | 28,325 |
| Italy | 238,833 | 34,675 |
| Iran | 209,970 | 9,863 |
| Germany | 192,778 | 8,986 |
| Mexico | 191,410 | 23,377 |
| Turkey | 190,165 | 5,001 |
| Pakistan | 185,034 | 3,695 |
| Saudi Arabia | 164,144 | 1,346 |
| France | 161,267 | 29,720 |

Table 11.4: **Confirmed cases and deaths as of 29 October, 2020**

| Country | cases | deaths |
|----------------|--------------|---------------|
| United States | 8,949,332 | 231,033 |
| India | 8,040,203 | 120,527 |
| Brazil | 5,469,755 | 158,468 |
| Russia | 1,563,976 | 26,935 |
| France | 1,235,132 | 35,785 |
| Spain | 1,136,503 | 35,466 |
| Argentina | 1,130,520 | 30,071 |
| Colombia | 1,041,935 | 30,753 |
| United Kingdom | 942,275 | 45,675 |
| Mexico | 906,863 | 90,309 |
| Peru | 894,928 | 34,315 |
| South Africa | 719,714 | 19,111 |
| Italy | 589,766 | 37,905 |
| Iran | 588,648 | 33,714 |
| Chile | 505,530 | 14,032 |
| Germany | 479,621 | 10,359 |
| Iraq | 463,951 | 10,770 |

Table 11.5: Some pandemics of the past

| name | time period | type | deaths |
|---------------------|--------------------|--------------------------|---------------|
| Antonine Plague | 165-180 | smallpox or measles | 5,000,000 |
| Japanese Smallpox | 735-737 | Variola major virus | 1,000,000 |
| Plague of Justinian | 541-542 | Yersinia pestis bacteria | c.40,000,000 |
| Black Death | 1347-1351 | Yersinia pestis bacteria | 200,000,000 |
| New World Smallpox | 1320- | Variola major virus | 56,000,000 |
| Plague of London | 1665 | Yersinia pestis bacteria | 100,000 |
| Italian plague | 1629-1631 | Yersinia pestis bacteria | 1,000,000 |
| Cholera Pandemics | 1817-1923 | V. cholerae bacteria | 1,000,000+ |
| Third Plague | 1885 | Yersinia pestis bacteria | 12,000,000 |
| Yellow Fever | Late 1800s | Yellow Fever virus | c.125,000 |
| Russian Flu | 1889-1890 | Believed to be H2N2 | 1,000,000 |
| Spanish Flu | 1918-1919 | H1N1 virus | c.45,000,000 |
| Asian Flu | 1957-1958 | H2N2 virus | 1,100,000 |
| Hong Kong Flu | 1968-1970 | H3N2 virus | 1,000,000 |
| HIV/AIDS | 1981- | HIV/AIDS virus | c.30,000,000 |
| Swine Flu | 2009-2010 | H1N1 virus | 200,000 |

We need solidarity, not sanctions

According to the United Nations Charter, only the Security Council may impose sanctions. No individual nation may do so. Nevertheless, the United States currently imposes economic sanctions on Iran, North Korea, Sudan, Cuba, Venezuela, Belarus, Burundi, Central African Republic, China, Comoros, Democratic Republic of the Congo, Equatorial Guinea, Eritria, Iraq, Lebanon, Libya, Mauritania, Myanmar, Nicaragua, Papua New Guinea, Russia, Somalia, South Sudan, Turkmenistan, Ukraine, Venezuela, Yemen and Zimbabwe.

Besides violating the United Nations Charter, these unilaterally imposed sanctions also violate the Fourth Geneva Convention, under which collective punishment is a war crime. Article 33 states that “No protected person may be punished for an offense that he or she did not personally commit”.

The sanctions that are currently being imposed on Iran are also an example of collective punishment. They are damaging the health of ordinary Iranian citizens, who can in no way be blamed for the policies of their government. According to Wikipedia: “Pharmaceuticals and medical equipment do not fall under the international sanctions, but the country is facing shortages of drugs for the treatment of 30 illnesses, including cancer, heart and breathing problems, thalassemia and multiple sclerosis, because Iran is not allowed to use International payment systems.... In addition, there are 40,000 haemophiliacs who can’t get anti-clotting medicines... An estimated 23,000 Iranians with HIV/Aids have had their access to the drugs they need to keep alive severely restricted.”

During the present COVID-19 pandemic, economic sanctions are particularly cruel and inhuman. They deprive the affected nations of desperately-needed face masks, respirators and medicines. During this terrible emergency, humanity must unite. We need solidarity, not sanctions!

Gestures of solidarity during the pandemic

Here are a few stories of solidarity during the COVID-19 crisis:

According to an article by Shannon Liao, published by CNN Business on March 14, 2020, “Chinese billionaire and Alibaba co-founder Jack Ma said he will donate 500,000 coronavirus testing kits and one million face masks to the United States... Ma has donated one million masks to Japan as of March 2 and had been attempting to ship one million masks to Iran as of March 6, according to his Weibo posts. In a March 11 post, he wrote that 1.8 million masks and 100,000 testing kits would go to Europe, with the first batch arriving in Belgium this week. He shared plans to donate to Italy and Spain, two other countries hard-hit by the virus, as well.”

Cuba has sent medical doctors and nurses to combat the COVID-19 pandemic in Italy. Cuba has also deployed doctors to Venezuela, Nicaragua, Jamaica, Suriname and Grenada.

On 3 April, 2020, the World Health Organization and UNESCO “announced an agreement to work together on COVID-19 response, through the historic COVID-19 Solidar-

ity Response Fund powered by the United Nations Foundation and Swiss Philanthropy Foundation. The COVID-19 Solidarity Response Fund has been set up to facilitate an unprecedented global response by supporting the WHO Strategic Preparedness and Response Plan. As part of the agreement, an initial portion of the money from the Fund - which currently stands at more than \$127 million - will flow to UNICEF for its work with vulnerable children and communities all over the world.”

Antonio Guterres proposes a global ceasefire

On 23 March, 2020, the United Nations Secretary General Antonio Guterres said:

“Our world faces a common enemy: COVID-19. The virus does not care about nationality or ethnicity, faction or faith. It attacks all, relentlessly. Meanwhile, armed conflict rages on around the world. The most vulnerable - women and children, people with disabilities, the marginalized and the displaced - pay the highest price. They are also at the highest risk of suffering devastating losses from COVID-19. Let’s not forget that in war-ravaged countries, health systems have collapsed. Health professionals, already few in number, have often been targeted. Refugees and others displaced by violent conflict are doubly vulnerable. The fury of the virus illustrates the folly of war. That is why today, I am calling for an immediate global ceasefire in all corners of the world. It is time to put armed conflict on lockdown and focus together on the true fight of our lives.”

We can learn from the pandemic

Terrible as it is, the COVID-19 pandemic may be able to teach us something. Humanity must work together to solve our common problems. We must abandon the folly of war, and use the vast sums of money now wasted (or worse than wasted) on armaments for constructive purposes, for example public health programs. We must work together to rebuild the world after the pandemic. The new world that we build, must be sustainable, and it must have both an environmental conscience and a social conscience

Suggestions for further reading

1. Breathnach, C S (September 1984). *Biographical sketches-No. 44. Metchnikoff*. Irish Medical Journal. Ireland. 77 (9).
2. de Kruif, Paul (1996). *Microbe Hunters*. San Diego: A Harvest Book.
3. Deutsch, Ronald M. (1977). *The new nuts among the berries*. Palo Alto, CA: Bull Pub. Co.
4. Fokin, Sergei I. (2008). *Russian scientists at the Naples zoological station, 1874 - 1934*. Napoli: Giannini.
5. Gourko, Helena; Williamson, Donald I.; Tauber, Alfred I. (2000). *The Evolutionary Biology Papers of Elie Metchnikoff*. Dordrecht: Springer Netherlands.
6. Karnovsky, M L (May 1981). *Metchnikoff in Messina: a century of studies on phagocytosis*. N. Engl. J. Med. United States. 304 (19): 1178-80.

7. Lavrova, L N (September 1970). *I. I. Mechnikov and the significance of his legacy for the development of Soviet science (on the 125th anniversary of his birth)*. Zh. Mikrobiol. Epidemiol. Immunobiol. USSR. 47 (9): 3-5.
8. Metchnikoff, Olga (2014) [1921]. *Life of Elie Metchnikoff 1845-1916*. The Floating Press.
9. Schmalstieg Frank C, Goldman Armond S (2008). *Ilya Ilich Metchnikoff (1845-1915) and Paul Ehrlich (1854-1915) The centennial of the 1908 Nobel Prize in Physiology or Medicine*. Journal of Medical Biography. 16 (2): 96-103.
10. Tauber AI (2003). *Metchnikoff and the phagocytosis theory*. Nature Reviews Molecular Cell Biology. 4 (11): 897-901.
11. Tauber, Alfred I.; Chernyak, Leon (1991). *Metchnikoff and the Origins of Immunology: From Metaphor to Theory*. New York: Oxford University Press.
12. Zalkind, Semyon (2001) [1957]. *Ilya Mechnikov: His Life and Work*. The Minerva Group, Inc.
13. Jerne, N. K. (1955). *The Natural-Selection Theory of Antibody Formation* (PDF). Proceedings of the National Academy of Sciences of the United States of America. 41 (11): 849-857.
14. Jerne, N. K. (1974). *Towards a network theory of the immune system*. Annales d'immunologie. 125C (1-2): 373-389.
15. Jerne, N.K. (1984), *Nobel lecture: The Generative Grammar of the Immune System* (PDF), Nobelprize.org, retrieved 8 July 2019.
16. Hoffmann, G.W. (1994), *Niels Jerne, Immunologist 1911-1994*, Vaccine Research, Mary Ann Liebert, Inc., 3: 173-174, archived from the original on 6 October 2014.
17. Dubiski, S. (2004). *Science as Autobiography: The Troubled Life of Niels Jerne*. JAMA: the Journal of the American Medical Association. 291 (10): 1267.
18. Podolsky, Alfred I. Tauber; Scott H. (1997). *The Generation of Diversity : Clonal Selection Theory and the Rise of Molecular Immunology* (1st paperback ed.). Cambridge, Massachusetts: Harvard Univ. Press.
19. *Biology in Context - The Spectrum of Life* Authors, Peter Aubusson, Eileen Kennedy.
20. Forsdyke D.R. (1995). *The Origins of the Clonal Selection Theory of Immunity*. FASEB Journal. 9: 164-66.
21. G. Köhler and C. Milstein (1975). *Continuous cultures of fused cells secreting antibody of predefined specificity*. Nature. 256 (5517): 495-7.
22. István Hargittai (2006). *Köhler's Invention*. Journal Structural Chemistry. 17 (1)
23. Melchers, F (1995). *Georges Köhler (1946-95)*. Nature. 374 (6522) (published Apr 6, 1995). p. 498.
24. Danon, Y L (1996). *Monoclonal antibodies: George Kohler*. Harefuah. 130 (2) (published Jan 15, 1996). pp. 108-9.
25. Armstrong, Dorsey (2016). *The Black Death: The World's Most Devastating Plague*. The Great Courses.
26. Benedictow, Ole Jørgen (2004). *Black Death 1346-1353: The Complete History*.
27. Byrne, J. P. (2004). *The Black Death*. London. Greenwood Publishing Group.

28. Cantor, Norman F. (2001). *In the Wake of the Plague: The Black Death and the World It Made*, New York, Free Press.
29. Cohn, Samuel K. Jr., (2002). *The Black Death Transformed: Disease and Culture in Early Renaissance Europe*, London: Arnold.
30. Gasquet, Francis Aidan (1893). *The Great Pestilence AD 1348 to 1349: Now Commonly Known As the Black Death*.
31. Hecker, J.F.C. (1859). B.G. Babington (trans) (ed.). *Epidemics of the Middle Ages*. London: Tr \tilde{A} $\frac{1}{4}$ bner.
32. Herlihy, D., (1997). *The Black Death and the Transformation of the West*, Cambridge, Massachusetts: Harvard University Press.
33. McNeill, William H. (1976). *Plagues and Peoples*. Anchor/Doubleday.
34. Scott, S., and Duncan, C. J., (2001). *Biology of Plagues: Evidence from Historical Populations*, Cambridge: Cambridge University Press.
35. Shrewsbury, J. F. D., (1970). *A History of Bubonic Plague in the British Isles*, London: Cambridge University Press.
36. Twigg, G., (1984). *The Black Death: A Biological Reappraisal*, London: Batsford.
37. Ziegler, Philip (1998). *The Black Death*. Penguin Books. 1st editions 1969.
38. H. Lodish, A. Berk, S.L. Zipursky, P. Matsudaira, D. Baltimore, and J. Darnell, *Molecular Cell Biology, 4th Edition*, W.H. Freeman, New York, (2000).
39. Lily Kay, *Who Wrote the Book of Life? A History of the Genetic Code*, Stanford University Press, Stanford CA, (2000).
40. Sahotra Sarkar (editor), *The Philosophy and History of Molecular Biology*, Kluwer Academic Publishers, Boston, (1996).
41. James D. Watson et al. *Molecular Biology of the Gene, 4th Edition*, Benjamin-Cummings, (1988).
42. J.S. Fruton, *Proteins, Enzymes, and Genes*, Yale University Press, New Haven, (1999).
43. S.E. Lauria, *Life, the Unfinished Experiment*, Charles Scribner's Sons, New York (1973).
44. A. Lwoff, *Biological Order*, MIT Press, Cambridge MA, (1962).
45. James D. Watson, *The Double Helix*, Athenium, New York (1968).
46. F. Crick, *The genetic code*, Scientific American, **202**, 66-74 (1962).
47. F. Crick, *Central dogma of molecular biology*, Nature, **227**, 561-563 (1970).
48. David Freifelder (editor), *Recombinant DNA, Readings from the Scientific American*, W.H. Freeman and Co. (1978).
49. James D. Watson, John Tooze and David T. Kurtz, *Recombinant DNA, A Short Course*, W.H. Freeman, New York (1983).
50. Richard Hutton, *Biorevolution, DNA and the Ethics of Man-Made Life*, The New American Library, New York (1968).
51. Martin Ebon, *The Cloning of Man*, The New American Library, New York (1978).
52. Sheldon Krinsky, *Genetic Alchemy: The Social History of the Recombinant DNA Controversy*, MIT Press, Cambridge Mass (1983).
53. M. Lappe, *Germs That Won't Die*, Anchor/Doubleday, Garden City N.Y. (1982).

54. M. Lappe, *Broken Code*, Sierra Club Books, San Francisco (1984).
55. President's Commission for the Study of Ethical Problems in Medicine and Biomedical and Behavioral Research, *Splicing Life: The Social and Ethical Issues of Genetic Engineering with Human Beings*, U.S. Government Printing Office, Washington D.C. (1982).
56. U.S. Congress, Office of Technology Assessment, *Impacts of Applied Genetics - Microorganisms, Plants and Animals*, U.S. Government Printing Office, Washington D.C. (1981).
57. W.T. Reich (editor), *Encyclopedia of Bioethics*, The Free Press, New York (1978).
58. Martin Brown (editor), *The Social Responsibility of the Scientist*, The Free Press, New York (1970).
59. B. Zimmerman, *Biofuture*, Plenum Press, New York (1984).
60. John Lear, *Recombinant DNA, The Untold Story*, Crown, New York (1978).
61. B. Alberts, D. Bray, J. Lewis, M. Raff, K. Roberts and J.D. Watson, *Molecular Biology of the Cell*, Garland, New York (1983).
62. C. Woese, *The Genetic Code; The Molecular Basis for Genetic Expression*, Harper and Row, New York, (1967).
63. F.H.C. Crick, *The Origin of the Genetic Code*, J. Mol. Biol. **38**, 367-379 (1968).
64. M.W. Niernberg, *The genetic code: II*, Scientific American, **208**, 80-94 (1962).
65. L.E. Orgel, *Evolution of the Genetic Apparatus*, J. Mol. Biol. **38**, 381-393 (1968).
66. Melvin Calvin, *Chemical Evolution Towards the Origin of Life, on Earth and Elsewhere*, Oxford University Press (1969).
67. R. Shapiro, *Origins: A Skeptic's Guide to the Origin of Life*, Summit Books, New York, (1986).
68. J. William Schopf, *Earth's earliest biosphere: its origin and evolution*, Princeton University Press, Princeton, N.J., (1983).
69. J. William Schopf (editor), *Major Events in the History of Life*, Jones and Bartlet, Boston, (1992).
70. Robert Rosen, *Life itself: a comprehensive inquiry into the nature, origin and fabrication of life*, Columbia University Press, (1991).
71. R.F. Gesteland, T.R. Cech, and J.F. Atkins (editors), *The RNA World, 2nd Edition*, Cold Spring Harbor Laboratory Press, Cold Spring Harbor, New York, (1999).
72. C. de Duve, *Blueprint of a Cell*, Niel Patterson Publishers, Burlington N.C., (1991).
73. C. de Duve, *Vital Dust; Life as a Cosmic Imperative*, Basic Books, New York, (1995).
74. F. Dyson, *Origins of Life*, Cambridge University Press, (1985).
75. S.A. Kaufman, *Antichaos and adaptation*, Scientific American, 265, 78-84, (1991).
76. S.A. Kauffman, *The Origins of Order*, Oxford University Press, (1993).
77. F.J. Varela and J.-P. Dupuy, *Understanding Origins: Contemporary Views on the Origin of Life, Mind and Society*, Kluwer, Dordrecht, (1992).
78. Stefan Bengtson (editor) *Early Life on Earth; Nobel Symposium No. 84*, Columbia University Press, New York, (1994).
79. Herrick Baltscheffsky, *Origin and Evolution of Biological Energy Conversion*, VCH Publishers, New York, (1996).

80. J. Chilesa-Flores, T. Owen and F. Raulin (editors), *First Steps in the Origin of Life in the Universe*, Kluwer, Dordrecht, (2001).
81. R.E. Dickerson, *Nature* **283**, 210-212 (1980).
82. R.E. Dickerson, *Scientific American* **242**, 136-153 (1980).
83. C.R. Woese, *Archaeobacteria*, *Scientific American* **244**, 98-122 (1981).
84. N. Iwabe, K. Kuma, M. Hasegawa, S. Osawa and T. Miyata, *Evolutionary relationships of archaeobacteria, eubacteria, and eukaryotes inferred phylogenetic trees of duplicated genes*, *Proc. Nat. Acad. Sci. USA* **86**, 9355-9359 (1989).
85. C.R. Woese, O. Kundler, and M.L. Wheelis, *Towards a Natural System of Organisms: Proposal for the Domains Archaea, Bacteria and Eucaria*, *Proc. Nat. Acad. Sci. USA* **87**, 4576-4579 (1990).
86. W. Ford Doolittle, *Phylogenetic Classification and the Universal Tree*, *Science*, **284**, (1999).
87. G. Wächterhäuser, *Pyrite formation, the first energy source for life: A hypothesis*, *Systematic and Applied Microbiology* **10**, 207-210 (1988).
88. G. Wächterhäuser, *Before enzymes and templates: Theory of surface metabolism*, *Microbiological Reviews*, **52**, 452-484 (1988).
89. G. Wächterhäuser, *Evolution of the first metabolic cycles*, *Proc. Nat. Acad. Sci. USA* **87**, 200-204 (1990).
90. G. Wächterhäuser, *Groundworks for an evolutionary biochemistry the iron-sulfur world*, *Progress in Biophysics and Molecular Biology* **58**, 85-210 (1992).
91. M.J. Russell and A.J. Hall, *The emergence of life from iron monosulphide bubbles at a submarine hydrothermal redox and pH front* *J. Geol. Soc. Lond.* **154**, 377-402, (1997).
92. L.H. Caporale (editor), *Molecular Strategies in Biological Evolution*, *Ann. N.Y. Acad. Sci.*, May 18, (1999).
93. W. Martin and M.J. Russell, *On the origins of cells: a hypothesis for the evolutionary transitions from abiotic geochemistry to chemoautotrophic prokaryotes, and from prokaryotes to nucleated cells*, *Philos. Trans. R. Soc. Lond. B Biol. Sci.*, **358**, 59-85, (2003).
94. Werner Arber, *Elements in Microbial Evolution*, *J. Mol. Evol.* **33**, 4 (1991).
95. Michael Gray, *The Bacterial Ancestry of Plastids and Mitochondria*, *BioScience*, **33**, 693-699 (1983).
96. Michael Grey, *The Endosymbiont Hypothesis Revisited*, *International Review of Cytology*, **141**, 233-257 (1992).
97. Lynn Margulis and Dorian Sagan, *Microcosmos: Four Billion Years of Evolution from Our Microbial Ancestors*, Allan and Unwin, London, (1987).
98. Lynn Margulis and Rene Fester, eds., *Symbiosis as a Source of Evolutionary Innovation: Speciation and Morphogenesis*, MIT Press, (1991).
99. Charles Mann, *Lynn Margulis: Science's Unruly Earth Mother*, *Science*, **252**, 19 April, (1991).
100. Jan Sapp, *Evolution by Association; A History of Symbiosis*, Oxford University Press, (1994).

101. J.A. Shapiro, *Natural genetic engineering in evolution*, *Genetics*, **86**, 99-111 (1992).
102. E.M. De Robertis et al., *Homeobox genes and the vertebrate body plan*, *Scientific American*, July, (1990).
103. J.S. Schrum, T.F. Zhu and J.W. Szostak, *The origins of cellular life*, *Cold Spring Harb. Perspect. Biol.*, May 19 (2010).
104. I. Budin and J.W. Szostak, *Expanding Roles for Diverse Physical Phenomena During the Origin of Life*, *Annu. Rev. Biophys.*, **39**, 245-263, (2010).
105. Clifford Dobell (editor), *Antony van Leeuwenhoek and his Little Animals*, Dover, New York (1960).
106. Paul de Kruif, *Microbe Hunters*, Pocket Books Inc., New York (1959).
107. René Dubos, *Pasteur and Modern Science*, Heinemann, London (1960).
108. A.P. Waterson and Lise Wilkinson, *An Introduction to the History of Virology*, Cambridge University Press (1978).
109. P.E. Baldry, *The Battle Against Bacteria*, Cambridge University Press (1965).
110. L. Wilkinson, *Animals and Disease; An Introduction to the History of Comparative Medicine*, Cambridge University Press, (1992).
111. Arthur Rook (editor), *The Origins and Growth of Biology*, Penguin Books Ltd. (1964).

Chapter 12

WAR TODAY

12.1 Militarism and money

Military-industrial complexes throughout the world involve a circular flow of money. The vast profits from arms industries are used to buy the votes of politicians, who then vote for obscenely bloated “defense” budgets. Military-industrial complexes need enemies. Without them they would wither. Thus, tensions are manufactured by corrupt politicians in the pay of arms industries. As Arundhati Roy famously observed, “Once weapons were manufactured to fight wars. Now wars are manufactured to sell weapons.” Donald Trump has recently threatened to attack both Iran and North Korea with nuclear weapons. The United States, under Trump, is also threatening both Russia and China. Any such conflict could escalate uncontrollably into an all-destroying global thermonuclear war.

12.2 Ethology

In the long run, because of the terrible weapons that have already been produced through the misuse of science, and because of the even more terrible weapons that are likely to be invented in the future, the only way in which we can ensure the survival of civilization is to abolish the institution of war. But is this possible? Or are the emotions that make war possible so much a part of human nature that we cannot stop humans from fighting any more than we can stop cats and dogs from fighting? Can biological science throw any light on the problem of why our supposedly rational species seems intent on choosing war, pain and death instead of peace, happiness and life? To answer this question, we need to turn to the science of ethology - the study of inherited emotional tendencies and behavior patterns in animals and humans.

In *The Origin of Species*, Charles Darwin devoted a chapter to the evolution of instincts, and he later published a separate book on *The Expression of the Emotions in Man and Animals*. Because of these pioneering studies, Darwin is considered to be the founder of ethology.

The study of inherited behavior patterns in animals (and humans) was continued in

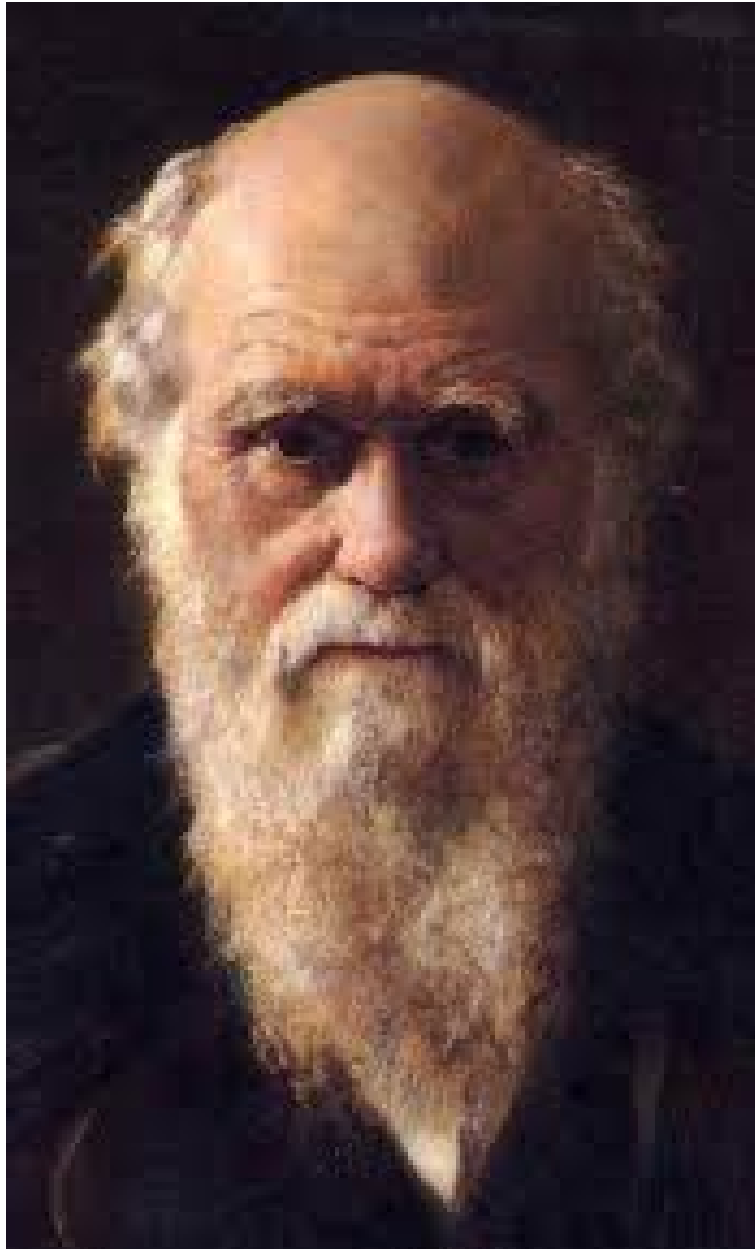

Figure 12.1: Because of Charles Darwin's book "The Expression of Emotions in Man and Animals", he is considered to be the founder of the field of Ethology, the study of inherited behavior patterns.



Figure 12.2: **Nikolaas Tinbergen (1907-1988) on the left, with Konrad Lorenz (1903-1989). Together with Karl von Frisch (1886-1982) they shared the 1973 Nobel Prize in Physiology and Medicine for their pioneering work in Ethology.**

the 20th century by such researchers as Karl von Frisch (1886-1982), Nikolaas Tinbergen (1907-1988), and Konrad Lorenz (1903-1989), three scientists who shared a Nobel Prize in Medicine and Physiology in 1973.

The third of the 1973 prizewinners, Konrad Lorenz, is controversial, but at the same time very interesting in the context of studies of the causes of war and discussions of how war may be avoided. As a young boy, he was very fond of animals, and his tolerant parents allowed him to build up a large menagerie in their house in Altenberg, Austria. Even as a child, he became an expert on waterfowl behavior, and he discovered the phenomenon of imprinting. He was given a one day old duckling, and found, to his intense joy, that it transferred its following response to his person. As Lorenz discovered, young waterfowl have a short period immediately after being hatched, when they identify as their “mother” whomever they see first. In later life, Lorenz continued his studies of imprinting, and there exists a touching photograph of him, with his white beard, standing waist-deep in a pond, surrounded by an adoring group of goslings who believe him to be their mother. Lorenz also studied bonding behavior in waterfowl.

It is, however, for his controversial book *On Aggression* that Konrad Lorenz is best known. In this book, Lorenz makes a distinction between intergroup aggression and intragroup aggression. Among animals, he points out, rank-determining fights are seldom fatal. Thus, for example, the fights that determine leadership within a wolf pack end when the loser makes a gesture of submission. By contrast, fights between groups of animals are often fights to the death, examples being wars between ant colonies, or of bees against intruders, or the defense of a rat pack against strange rats.

Many animals, humans included, seem willing to kill or be killed in defense of the communities to which they belong. Lorenz calls this behavioral tendency a “communal



Figure 12.3: Konrad Lorenz with geese who consider him to be their mother.

defense response". He points out that the "holy shiver" - the tingling of the spine that humans experience when performing a heroic act in defense of their communities - is related to the prehuman reflex for raising the hair on the back of an animal as it confronts an enemy - a reflex that makes the animal seem larger than it really is.

In his book *On Aggression*, Konrad Lorenz gives the following description of the emotions of a hero preparing to risk his life for the sake of the group:

"In reality, militant enthusiasm is a specialized form of communal aggression, clearly distinct from and yet functionally related to the more primitive forms of individual aggression. Every man of normally strong emotions knows, from his own experience, the subjective phenomena that go hand in hand with the response of militant enthusiasm. A shiver runs down the back and, as more exact observation shows, along the outside of both arms. One soars elated, above all the ties of everyday life, one is ready to abandon all for the call of what, in the moment of this specific emotion, seems to be a sacred duty. All obstacles in its path become unimportant; the instinctive inhibitions against hurting or killing one's fellows lose, unfortunately, much of their power. Rational considerations, criticisms, and all reasonable arguments against the behavior dictated by militant enthusiasm are silenced by an amazing reversal of all values, making them appear not only untenable, but base and dishonorable.

Men may enjoy the feeling of absolute righteousness even while they commit atrocities. Conceptual thought and moral responsibility are at their lowest ebb. As the Ukrainian proverb says: 'When the banner is unfurled, all reason is in the trumpet'."

"The subjective experiences just described are correlated with the following objectively demonstrable phenomena. The tone of the striated musculature is raised, the carriage is stiffened, the arms are raised from the sides and slightly rotated inward, so that the elbows point outward. The head is proudly raised, the chin stuck out, and the facial muscles mime the 'hero face' familiar from the films. On the back and along the outer surface of the arms, the hair stands on end. This is the objectively observed aspect of the shiver!"

"Anybody who has ever seen the corresponding behavior of the male chimpanzee defending his band or family with self-sacrificing courage will doubt the purely spiritual character of human enthusiasm. The chimp, too, sticks out his chin, stiffens his body, and raises his elbows; his hair stands on end, producing a terrifying magnification of his body contours as seen from the front. The inward rotation of the arms obviously has the purpose of turning the longest-haired side outward to enhance the effect. The whole combination of body attitude and hair-raising constitutes a bluff. This is also seen when a cat humps its back, and is calculated to make the animal appear bigger and more dangerous than it really is. Our shiver, which in German poetry is called a 'heiliger Schauer', a 'holy' shiver, turns out to be the vestige of a prehuman vegetative response for making a fur bristle which we no longer have. To the humble seeker for biological truth, there cannot be the slightest doubt that human militant enthusiasm evolved out of a communal defense response of our prehuman ancestor."

Lorenz goes on to say, "An impartial visitor from another planet, looking at man as he is today - in his hand the atom bomb, the product of his intelligence - in his heart the aggression drive, inherited from his anthropoid ancestors, which the same intelligence

cannot control - such a visitor would not give mankind much chance of survival.”

In an essay entitled *The Urge to Self-Destruction*¹, Arthur Koestler says:

“Even a cursory glance at history should convince one that individual crimes, committed for selfish motives, play a quite insignificant role in the human tragedy compared with the numbers massacred in unselfish love of one’s tribe, nation, dynasty, church or ideology... Wars are not fought for personal gain, but out of loyalty and devotion to king, country or cause...”

“We have seen on the screen the radiant love of the Führer on the faces of the Hitler Youth... They are transfixed with love, like monks in ecstasy on religious paintings. The sound of the nation’s anthem, the sight of its proud flag, makes you feel part of a wonderfully loving community. The fanatic is prepared to lay down his life for the object of his worship, as the lover is prepared to die for his idol. He is, alas, also prepared to kill anybody who represents a supposed threat to the idol.” The emotion described here by Koestler is the same as the communal defense mechanism (“militant enthusiasm”) described in biological terms by Lorenz.

Generations of schoolboys have learned the Latin motto: “Dulce et decorum est pro patria mori” - it is both sweet and noble to die for one’s country. Even in today’s world, death in battle in defense of country and religion is still praised by nationalists. However, because of the development of weapons of mass destruction, both nationalism and narrow patriotism have become dangerous anachronisms.

In thinking of violence and war, we must be extremely careful not to confuse the behavioral patterns that lead to wife-beating or bar-room brawls with those that lead to episodes like the trench warfare of the First World War, or to the nuclear bombing of Hiroshima and Nagasaki. The first type of aggression is similar to the rank-determining fights of animals, while the second is more akin to the team-spirit exhibited by a football side. Heroic behavior in defense of one’s community has been praised throughout the ages, but the tendency to such behavior has now become a threat to the survival of civilization, since tribalism makes war possible, and war with thermonuclear weapons threatens civilization with catastrophe.

Warfare involves not only a high degree of aggression, but also an extremely high degree of altruism. Soldiers kill, but they also sacrifice their own lives. Thus patriotism and duty are as essential to war as the willingness to kill. As Arthur Koestler points out, “Wars are not fought for personal gain, but out of loyalty and devotion to king, country or cause...”

Tribalism involves passionate attachment to one’s own group, self-sacrifice for the sake of the group, willingness both to die and to kill if necessary to defend the group from its enemies, and belief that in case of a conflict, one’s own group is always in the right.

¹in *The Place of Value in a World of Facts*, A. Tiselius and S. Nielsson editors, Wiley, New York, (1970)

12.3 Population genetics

If we examine altruism and aggression in humans, we notice that members of our species exhibit great altruism towards their own children. Kindness towards close relatives is also characteristic of human behavior, and the closer the biological relationship is between two humans, the greater is the altruism they tend to show towards each other. This profile of altruism is easy to explain on the basis of Darwinian natural selection since two closely related individuals share many genes and, if they cooperate, the genes will be more effectively propagated.

To explain from an evolutionary point of view the communal defense mechanism discussed by Lorenz - the willingness of humans to kill and be killed in defense of their communities - we have only to imagine that our ancestors lived in small tribes and that marriage was likely to take place within a tribe rather than across tribal boundaries. Under these circumstances, each tribe would tend to consist of genetically similar individuals. The tribe itself, rather than the individual, would be the unit on which the evolutionary forces of natural selection would act. The idea of group selection in evolution was proposed in the 1930's by J.B.S. Haldane and R.A. Fisher, and more recently it has been discussed by W.D. Hamilton and E.O. Wilson.

According to the group selection model, a tribe whose members showed altruism towards each other would be more likely to survive than a tribe whose members cooperated less effectively. Since several tribes might be in competition for the same territory, intertribal aggression might, under some circumstances, increase the chances for survival of one's own tribe. Thus, on the basis of the group selection model, one would expect humans to be kind and cooperative towards members of their own group, but at the same time to sometimes exhibit aggression towards members of other groups, especially in conflicts over territory. One would also expect intergroup conflicts to be most severe in cases where the boundaries between groups are sharpest - where marriage is forbidden across the boundaries.



Figure 12.4: Sir Ronald Aylmer Fischer (1890-1962). Together with J.B.S Haldane he pioneered the theory of population genetics. Recent contributions to this theory have been made by W.D. Hamilton and E.O. Wilson.

12.4 Hope for the future

Although humans originally lived in small, genetically homogeneous tribes, the social and political groups of the modern world are much larger, and are often multiracial and multiethnic.

There are a number of large countries that are remarkable for their diversity, for example Brazil, Argentina and the United States. Nevertheless it has been possible to establish social cohesion and group identity within each of these enormous nations. India and China too, are mosaics of diverse peoples, but nevertheless, they function as coherent societies. Thus we see that group identity is a social construction, in which artificial “tribal markings” define the boundaries of the group. These tribal markings will be discussed in more detail below.

One gains hope for the future by observing how it has been possible to produce both internal peace and social cohesion over very large areas of the globe - areas that contain extremely diverse populations. The difference between making large, ethnically diverse countries function as coherent sociopolitical units and making the entire world function as a unit is not very great.

Since group identity is a social construction, it is not an impossible goal to think of enlarging the already-large groups of the modern world to include all of humanity.

On our small but beautiful earth, made small by technology, made beautiful by nature, there is room for one group only: the all-inclusive family of humankind.

12.5 Religion and ethnic identity

An acceleration of human cultural development seems to have begun approximately 70,000 years ago. The first art objects date from that period, as do migrations that ultimately took modern man across the Bering Strait to the western hemisphere. A land bridge extending from Siberia to Alaska is thought to have been formed approximately 70,000 years ago, disappearing again roughly 10,000 years before the present. Cultural and genetic studies indicate that migrations from Asia to North America took place during this period. Shamanism,² which is found both in Asia and the new world, as well as among the Sami (Lapps) of northern Scandinavia, is an example of the cultural links between the hunting societies of these regions.

Before the acceleration of human cultural development just mentioned, genetic change and cultural change went hand in hand, but during the last 70,000 years, the constantly accelerating rate of information-accumulation and cultural evolution has increasingly out-distanced the rate of genetic change in humans. Genetically we are almost identical with our hunter-gatherer ancestors of 70,000 years ago, but cultural evolution has changed our way of life beyond recognition.

²A shaman is a special member of a hunting society who, while in a trance, is thought to be able pass between the upper world, the present world, and the lower world, to cure illnesses, and to insure the success of a hunt.

Humans are capable of cultural evolution because it is so easy to overwrite and modify our instinctive behavior patterns with learned behavior. Within the animal kingdom, humans are undoubtedly the champions in this respect. No other species is so good at learning as we are. During the early stages of cultural evolution, the tendency of humans to be religious may have facilitated the overwriting of instinctive behavior with the culture of the tribe. Since religions, like languages, are closely associated with particular cultures, they serve as marks of ethnic identity.

12.6 Tribal markings; ethnicity; pseudospeciation

In biology, a species is defined to be a group of mutually fertile organisms. Thus all humans form a single species, since mixed marriages between all known races will produce children, and subsequent generations in mixed marriages are also fertile. However, although there is never a biological barrier to marriages across ethnic and racial boundaries, there are often very severe cultural barriers.

Irenäus Eibl-Eibesfeldt, a student of Konrad Lorenz, introduced the word *pseudospeciation* to denote cases where cultural barriers between two groups of humans are so strongly marked that marriages across the boundary are difficult and infrequent. In such cases, he pointed out, the two groups function as though they were separate species, although from a biological standpoint this is nonsense. When two such groups are competing for the same land, the same water, the same resources, and the same jobs, the conflicts between them can become very bitter indeed. Each group regards the other as being “not truly human”.

In his book *The Biology of War and Peace*, Eibl-Eibesfeldt discusses the “tribal markings” used by groups of humans to underline their own identity and to clearly mark the boundary between themselves and other groups. One of the illustrations in the book shows the marks left by ritual scarification on the faces of the members of certain African tribes. These scars would be hard to counterfeit, and they help to establish and strengthen tribal identity. Seeing a photograph of the marks left by ritual scarification on the faces of African tribesmen, it is impossible not to be reminded of the dueling scars that Prussian army officers once used to distinguish their caste from outsiders.

Surveying the human scene, one can find endless examples of signs that mark the bearer as a member of a particular group - signs that can be thought of as “tribal markings”: tattoos; piercing; bones through the nose or ears; elongated necks or ears; filed teeth; Chinese binding of feet; circumcision, both male and female; unique hair styles; decorations of the tongue, nose, or naval; peculiarities of dress, fashions, veils, chadors, and headdresses; caste markings in India; use or nonuse of perfumes; codes of honor and value systems; traditions of hospitality and manners; peculiarities of diet (certain foods forbidden, others preferred); giving traditional names to children; knowledge of dances and songs; knowledge of recipes; knowledge of common stories, literature, myths, poetry or common history; festivals, ceremonies, and rituals; burial customs, treatment of the dead and ancestor worship; methods of building and decorating homes; games and sports peculiar to a culture;



Figure 12.5: A tatoed face can help to establish tribal identity



Figure 12.6: An example of the dueling scars that Prussian army officers once used to distinguish their caste from outsiders.

relationship to animals, knowledge of horses and ability to ride; nonrational systems of belief. Even a baseball hat worn backwards or the professed ability to enjoy atonal music can mark a person as a member of a special “tribe”. Undoubtedly there many people in New York who would never think of marrying someone who could not appreciate the the paintings of Jasper Johns, and many in London who would consider anyone had not read all the books of Virginia Wolfe to be entirely outside the bounds of civilization.

By far the most important mark of ethnic identity is language, and within a particular language, dialect and accent. If the only purpose of language were communication, it would be logical for the people of a small country like Denmark to stop speaking Danish and go over to a more universally-understood international language such as English. However, language has another function in addition to communication: It is also a mark of identity. It establishes the boundary of the group.

Within a particular language, dialects and accents mark the boundaries of subgroups. For example, in England, great social significance is attached to accents and diction, a tendency that George Bernard Shaw satirized in his play, *Pygmalion*, which later gained greater fame as the musical comedy, *My Fair Lady*. This being the case, we can ask why all citizens of England do not follow the example of Eliza Doolittle in Shaw’s play, and improve their social positions by acquiring Oxford accents. However, to do so would be to run the risk of being laughed at by one’s peers and regarded as a traitor to one’s own local community and friends. School children everywhere can be very cruel to any child who does not fit into the local pattern. At Eton, an Oxford accent is compulsory; but in a Yorkshire school, a child with an Oxford accent would suffer for it.

Next after language, the most important “tribal marking” is religion. As mentioned above, it seems probable that in the early history of our hunter-gatherer ancestors, religion evolved as a mechanism for perpetuating tribal traditions and culture. Like language, and like the innate facial expressions studied by Darwin, religion is a universal characteristic of all human societies. All known races and cultures practice some sort of religion. Thus a tendency to be religious seems to be built into human nature, or at any rate, the needs that religion satisfies seem to be a part of our inherited makeup. Otherwise, religion would not be so universal as it is.

Religion is often strongly associated with ethnicity and nationalism, that is to say, it is associated with the demarcation of a particular group of people by its culture or race. For example, the Jewish religion is associated with Zionism and with Jewish nationalism. Similarly Islam is strongly associated with Arab nationalism. Christianity too has played an important role in in many aggressive wars, for example in the Crusades, in the European conquest of the New World, in European colonial conquests in Africa and Asia, and in the wars between Catholics and Protestants within Europe.

Human history seems to be saturated with blood. It would be impossible to enumerate the conflicts with which the story of humankind is stained. Many of the atrocities of history have involved what Irenäus Eibl-Eibesfeldt called “pseudospeciation”, that is to say, they were committed in conflicts involving groups between which sharply marked cultural barriers have made intermarriage difficult and infrequent. Examples include the present conflict between Israelis and Palestinians; “racial cleansing” in Kosovo; the devas-

tating wars between Catholics and Protestants in Europe; the Lebanese civil war; genocide committed against Jews and Gypsies during World War II; recent genocide in Rwanda; current intertribal massacres in the Ituri Province of Congo; use of poison gas against Kurdish civilians by Saddam Hussein's regime in Iraq; the massacre of Armenians by Turks; massacres of Hindus by Muslims and of Muslims by Hindus in post-independence India; massacres of Native Americans by white conquerors and settlers in all parts of the New World; and massacres committed during the Crusades. The list seems almost endless.

Religion often contributes to conflicts by sharpening the boundaries between ethnic groups and by making marriage across those boundaries difficult and infrequent. However, this negative role is balanced by a positive one, whenever religion is the source of ethical principles, especially the principle of universal human brotherhood.

The religious leaders of today's world have the opportunity to contribute importantly to the solution of the problem of war. They have the opportunity to powerfully support the concept of universal human brotherhood, to build bridges between religious groups, to make intermarriage across ethnic boundaries easier, and to soften the distinctions between communities. Our political leaders have the duty to move away from nationalism and militarism. If they fail to do this, they will have failed humankind at a time of great danger and crisis.



Figure 12.7: An illustration from Darwin's book, "The Expression of Emotions in Man and Animals". Here a cat raises its back and fur when confronting an enemy to make itself seem larger and more dangerous. This reflex was later discussed by the ethologist Konrad Lorenz.



Figure 12.8: Professor E.O. Wilson of Harvard is famous for his books on Sociobiology.



Figure 12.9: **Professor Richard Dawkins** of Oxford, controversial author of “**The Selfish Gene**” and many other books. He has contributed much to the debate on relationships between science, religion, aggression and altruism.

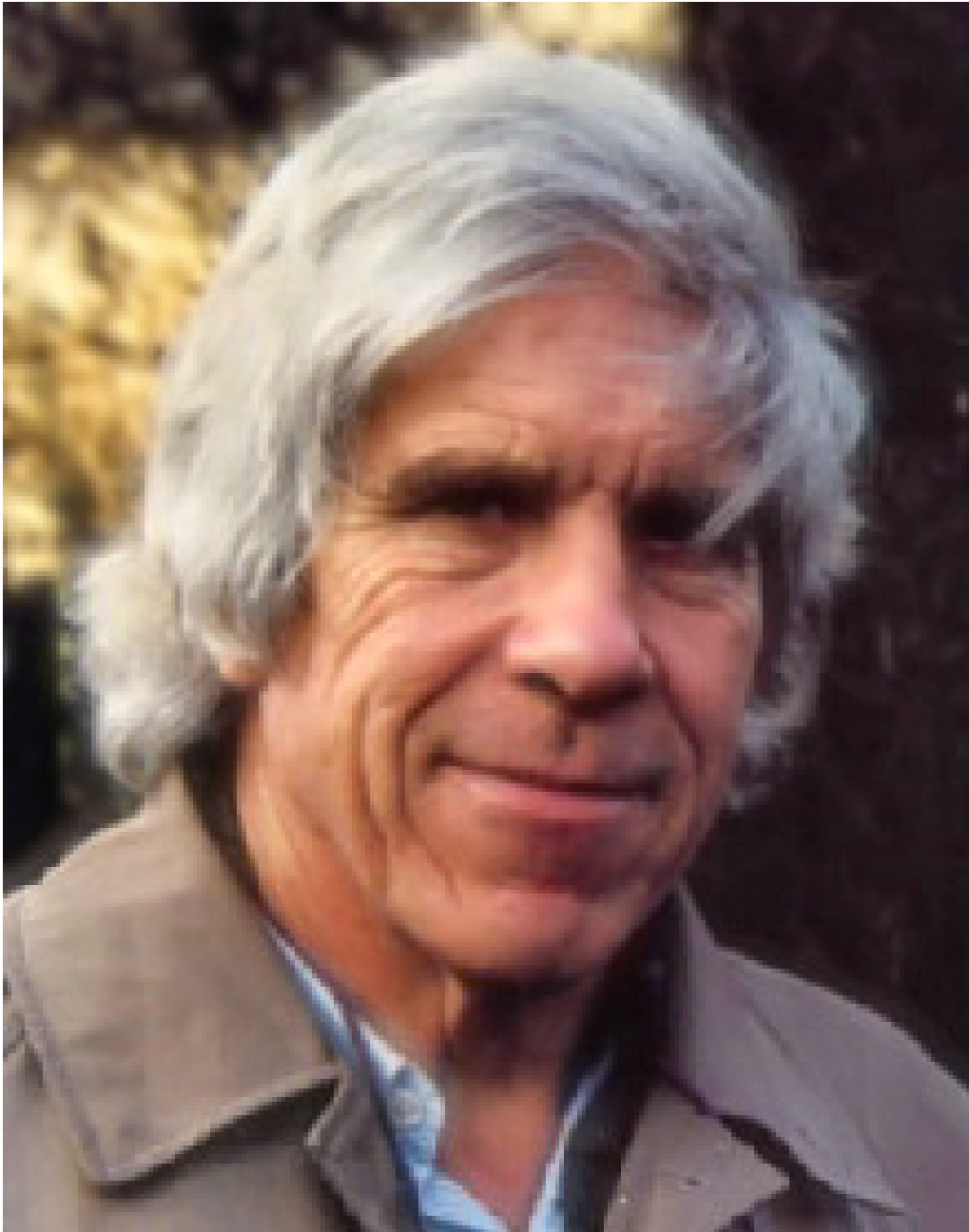

Figure 12.10: **William Donald Hamilton** was a Royal Society Research Professor at Oxford University until his death in 2000. He contributed importantly to our understanding of altruism from the standpoint of genetics.

12.7 The arms race prior to World War 1

The inherited tendency towards tribalism in human nature makes war possible. Humans are willing to kill and to be killed to defend their own group against perceived enemies. However, there is another element that drives and perpetuates the institution of war - the enormous amounts of money earned by arms manufacturers - the military-industrial complex against which Dwight D. Eisenhower warned in his famous farewell address.

In an article entitled *Arms Race Prior to 1914, Armament Policy*³, Eric Brose writes: “New weapons produced during the Industrial Revolution in the late 1800s heightened existing tensions among European nations as countries strove to outpace their enemies technologically. This armaments race accelerated in the decade before 1914 as the Triple Alliance of Germany, Austria-Hungary, and Italy squared off against the Triple Entente of France, Russia, and Britain. Germany’s fears of increases in Russian armaments, and British fears of the German naval buildup, contributed heavily to the outbreak and spread of the First World War in 1914.”

The Wikipedia article on *Arms race* states that “From 1897 to 1914, a naval arms race between the United Kingdom and Germany took place. British concern about rapid increase in German naval power resulted in a costly building competition of Dreadnought-class ships. This tense arms race lasted until 1914, when the war broke out. After the war, a new arms race developed among the victorious Allies, which was temporarily ended by the Washington Naval Treaty.

“In addition to the British and Germans, contemporaneous but smaller naval arms races also broke out between Russia and the Ottoman Empire; the Ottomans and Greece; France and Italy; the United States and Japan; and Brazil, Argentina, and Chile.

“The United Kingdom had the largest navy in the world. In accord with Wilhelm II’s enthusiasm for an expanded German navy and the strong desires of Grand Admiral Alfred von Tirpitz, Secretary of State of the German Imperial Naval Office, four Fleet Acts from 1898 and 1912 greatly expanded the German High Seas Fleet. The German aim was to build a fleet that would be two thirds the size of the British navy. The plan was sparked by the threat of the British Foreign Office in March 1897, after the British invasion of Transvaal that started the Boer War, of blockading the German coast and thereby crippling the German economy if Germany intervened in the conflict in Transvaal. From 1905 onward, the British navy developed plans for such a blockade, which was a central part of British strategy.

“In reaction to the challenge to its naval supremacy, from 1902 to 1910, the British Royal Navy embarked on a massive expansion to keep ahead of the Germans. The competition came to focus on the revolutionary new ships based on HMS Dreadnought, which was launched in 1906.”

³International Encyclopedia of the First World War

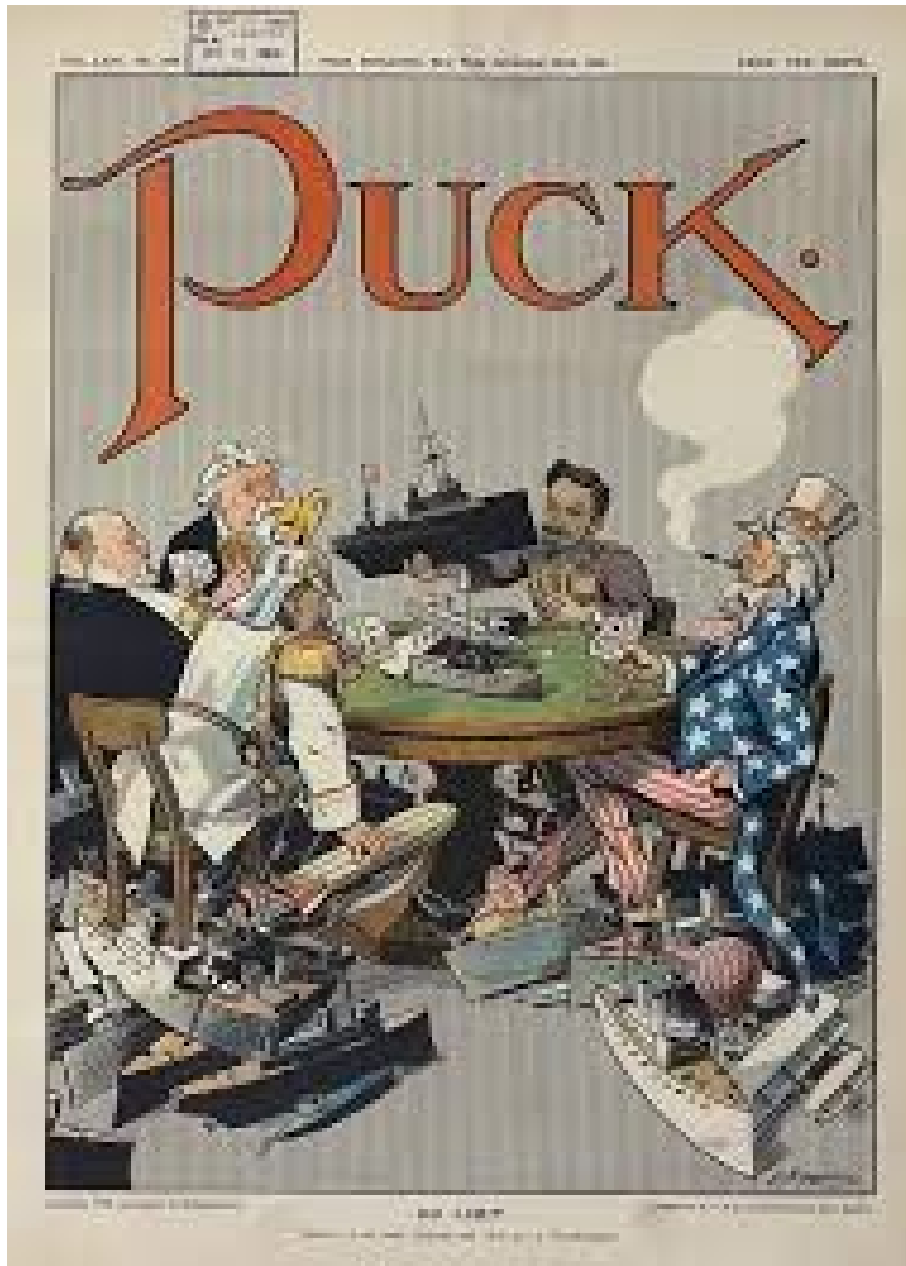

Figure 12.11: Left to right, US, Britain, Germany, France and Japan, engage in a “no limits” game for naval supremacy.

12.8 Krupp, Thyssen and Germany's steel industry

The Krupp family business, known as Friedrich Krupp AG, was the largest company in Europe at the beginning of the 20th century. It was important to weapons development and production in both world wars. One of the most powerful dynasties in European history, for 400 years Krupp flourished as the premier weapons manufacturer for Germany. From the Thirty Years' War until the end of the Second World War, they produced everything from battleships, U-boats, tanks, howitzers, guns, utilities, and hundreds of other commodities.

The Thyssen family similarly profited from the arms races prior to World War I and World War II. August Thyssen (1842-1925) founded a large iron and steel company in the Ruhr district of Germany, and was succeeded by his son Fritz Thyssen, who greatly aided Hitler's rise to power.

12.9 Colonialism and the outbreak of the First World War

The First World War broke out approximately 100 years ago, and much thought has been given to the causes of this tragic event, whose consequences continue to cast a dark shadow over the human future. When the war ended four years later, ten million young men had been killed and twenty million wounded, of whom six million were crippled for life. The war had cost 350,000,000,000 1919 dollars. This was a calculable cost; but the cost in human suffering and brutalization of values was incalculable.

It hardly mattered whose fault the catastrophe had been. Perhaps the Austrian government had been more to blame than any other. But blame for the war certainly did not rest with the Austrian people nor with the young Austrians who had been forced to fight. However, the tragedy of the First World War was that it created long-lasting hatred between the nations involved; and in this way it led, only twenty years later, to an even more catastrophic global war, during the course of which nuclear weapons were developed.

Most scholars believe that competing colonial ambitions played an important role in setting the stage for the First World War. A second factor was an armaments race between European countries, and the huge profits gained by arms manufacturers. Even at that time, the Military-industrial complex was firmly established; and today it continues to be the greatest source of war, together with neocolonialism.⁴

⁴<http://alphahistory.com/worldwar1/imperialism/>
<http://www.flowofhistory.com/units/etc/19/26>
<http://alphahistory.com/worldwar1/militarism/>



Figure 12.12: Map of European colonies in Africa in 1914, just before the First World War. Source: www.createdebate.com

12.10 Prescott Bush and Hitler

Prescott Sheldon Bush (1895-1972), the father of George H.W. Bush and grandfather of George W. Bush, actively supported the revival of Germany's armament's industry in the 1930's, as well as supplying large amounts of money to Adolf Hitler's Nazi Party.⁵

An article in *The Guardian*⁶, Ben Aris and Dubcab Campbell write that "George Bush's grandfather, the late US senator Prescott Bush, was a director and shareholder of companies that profited from their involvement with the financial backers of Nazi Germany.

"The Guardian has obtained confirmation from newly discovered files in the US National Archives that a firm of which Prescott Bush was a director was involved with the financial architects of Nazism.

"His business dealings, which continued until his company's assets were seized in 1942 under the Trading with the Enemy Act, has led more than 60 years later to a civil action for damages being brought in Germany against the Bush family by two former slave laborers at Auschwitz and to a hum of pre-election controversy.

"The debate over Prescott Bush's behavior has been bubbling under the surface for some time. There has been a steady Internet chatter about the "Bush-Nazi" connection,

⁵<https://www.youtube.com/watch?v=TnHnjmCYjy4>
<https://www.youtube.com/watch?v=7BZCfbrXKs4>
<https://www.youtube.com/watch?v=7BZCfbrXKs4>
<http://www.georgewalkerbush.net/bushfamilyfundedhitler.htm>
<http://www.theguardian.com/world/2004/sep/25/usa.secondworldwar>

⁶September 25, 2004



Figure 12.13: Prescott Bush, the father of George H.W. Bush and grandfather of George W. Bush, supported Hitler's rise to power with large financial contributions to the Nazi Party. The photo shows them together. Source: topinfopost.com

much of it inaccurate and unfair. But the new documents, many of which were only declassified last year, show that even after America had entered the war and when there was already significant information about the Nazis' plans and policies, he worked for and profited from companies closely involved with the very German businesses that financed Hitler's rise to power. It has also been suggested that the money he made from these dealings helped to establish the Bush family fortune and set up its political dynasty.

"Bush was also on the board of at least one of the companies that formed part of a multinational network of front companies to allow [Fritz] Thyssen to move assets around the world.

"Thyssen owned the largest steel and coal company in Germany and grew rich from Hitler's efforts to re-arm between the two world wars. One of the pillars in Thyssen's international corporate web, UBC, worked exclusively for, and was owned by, a Thyssen-controlled bank in the Netherlands. More tantalizing are Bush's links to the Consolidated Silesian Steel Company (CSSC), based in mineral rich Silesia on the German-Polish border. During the war, the company made use of Nazi slave labor from the concentration camps, including Auschwitz. The ownership of CSSC changed hands several times in the 1930s, but documents from the US National Archive declassified last year link Bush to CSSC, although it is not clear if he and UBC were still involved in the company when Thyssen's American assets were seized in 1942."

12.11 Fritz Thyssen supports Hitler's rise to power

“In 1923, Thyssen met former General Erich Ludendorff, who advised him to attend a speech given by Adolf Hitler, leader of the Nazi Party. Thyssen was impressed by Hitler and his bitter opposition to the Treaty of Versailles, and began to make large donations to the party, including 100,000 gold marks in 1923 to Ludendorff. In this he was unusual among German business leaders, as most were traditional conservatives who regarded the Nazis with suspicion. Thyssen's principal motive in supporting the National Socialists was his great fear of communism; he had little confidence that the various German anticommunist factions would prevent a Soviet-style revolution in Germany unless the popular appeal of communism among the lower classes was co-opted by an anticommunist alternative. Postwar investigators found that he had donated 650,000 Reichsmarks to right-wing parties, mostly to the Nazis, although Thyssen himself claimed to have donated 1 million marks to the Nazi Party. Thyssen remained a member of the German National People's Party until 1932, and did not join the Nazi Party (National Socialist German Workers' Party) until 1933.

“In November, 1932, Thyssen and Hjalmar Schacht were the main organizers of a letter to President Paul von Hindenburg urging him to appoint Hitler as Chancellor. Thyssen also persuaded the Association of German Industrialists to donate 3 million Reichsmarks to the Nazi Party (National Socialist German Workers' Party) for the March, 1933 Reichstag election. As a reward, he was elected a Nazi member of the Reichstag and appointed to the Council of State of Prussia, the largest German state (both purely honorary positions).

“Thyssen welcomed the suppression of the Communist Party, the Social Democrats and the trade unions. In 1934 he was one of the business leaders who persuaded Hitler to suppress the SA, leading to the “Night of the Long Knives”. Thyssen accepted the exclusion of Jews from German business and professional life by the Nazis, and dismissed his own Jewish employees. But as a Catholic, he objected to the increasing repression of the Roman Catholic Church, which gathered pace after 1935: in 1937 he sent a letter to Hitler, protesting the persecution of Christians in Germany.[4] The breaking point for Thyssen was the violent pogrom against the Jews in November 1938, known as Kristallnacht, which caused him to resign from the Council of State. By 1939 he was also bitterly criticizing the regime's economic policies, which were subordinating everything to rearmament in preparation for war.”



Figure 12.14: An arms race between the major European powers contributed to the start of World War I.



Figure 12.15: World War I was called “The War to End All Wars”. Today it seems more like The War that Began All Wars.



Figure 12.16: The naval arms race, which contributed to the start of World War I, enriched steel manufacturers and military shipbuilders.



Figure 12.17: Who is the leader, and who the follower?

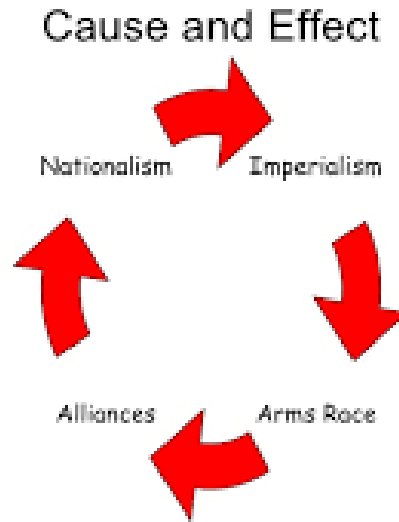

Figure 12.18: A vicious circle.

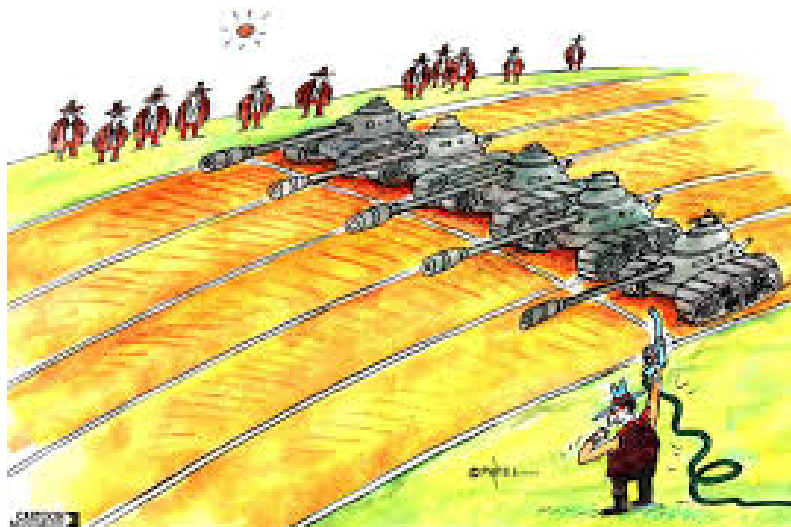

Figure 12.19: Ready, set, go!

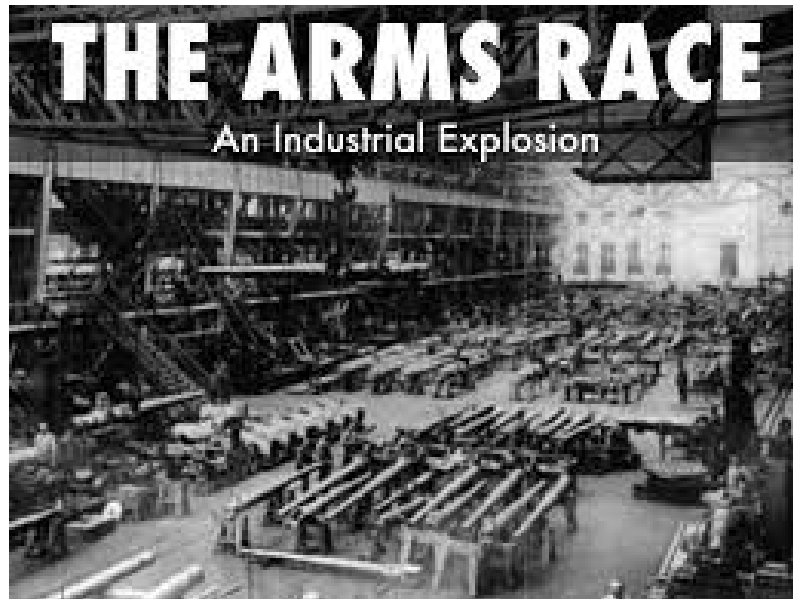

Figure 12.20: If our economies depend on armaments industries, it is an unhealthy dependence, analogous to drug addiction.



Figure 12.21: The nuclear arms race casts a dark shadow over the future of human civilization and the biosphere.



Figure 12.22: During the Cuban Missile Crisis, the world came close to a catastrophic thermonuclear war.

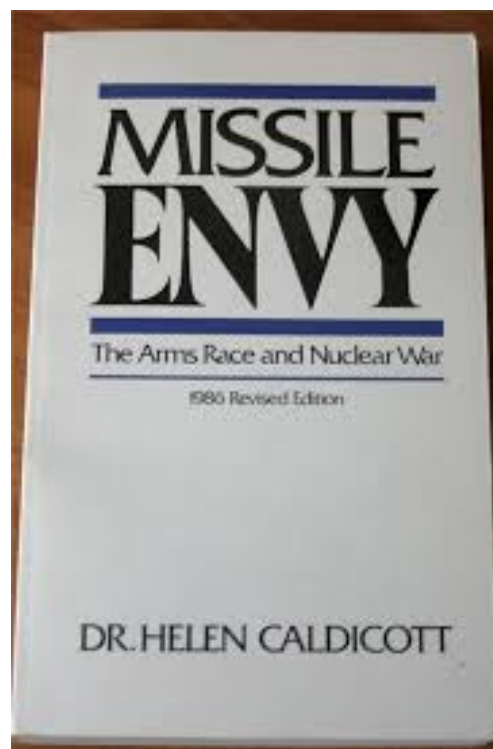

Figure 12.23: Dr. Helen Caldecott has worked to document the dangers of both nuclear weapons and nuclear power generation.



Figure 12.24: We must listen to the wise words of Dr. Martin Luther King, Jr.

12.12 Eisenhower’s farewell address

In his famous farewell address, US President Dwight Eisenhower eloquently described the terrible effects of an overgrown Military-industrial complex. Here are his words:

“We have been compelled to create a permanent armaments industry of vast proportions.... This conjunction of an immense military establishment and a large arms industry is new in the American experience. The total influence, economic, political, even spiritual, is felt in every city, every State house, every office of the Federal government...[and] we must not fail to comprehend its grave implications. Our toil, resources and livelihood are all involved; so is the very structure of our society.

“In the councils of government, we must guard against the acquisition of unwarranted influence, whether sought or unsought, by the Military-industrial complex. The potential for the disastrous rise of misplaced power exists and will persist.”

In another speech, he said: “Every gun that is made, every warship launched, every rocket fired signifies, in the final sense, a theft from those who hunger and are not fed, those who are cold and are not clothed. This world in arms is not spending money alone. It is spending the sweat of its laborers, the genius of its scientists, the hopes of its children.”

Today the world spends more than 1.7 trillion dollars (\$ 1,700,000,000,000) every year on armaments. This vast river of money, almost too large to be imagined, is the “devil’s dynamo” driving the institution of war. Politicians notoriously can be bought with a tiny fraction of this enormous amount; hence the decay of democracy. It is also plain that if the almost unbelievable sums now wasted on armaments were used constructively, most of the pressing problems now facing humanity could be solved.

Because the world spends almost two thousand billion dollars each year on armaments, it follows that very many people make their living from war. This is the reason why it is correct to speak of war as an institution, and why it persists, although we know that it is the cause of much of the suffering that inflicts humanity.

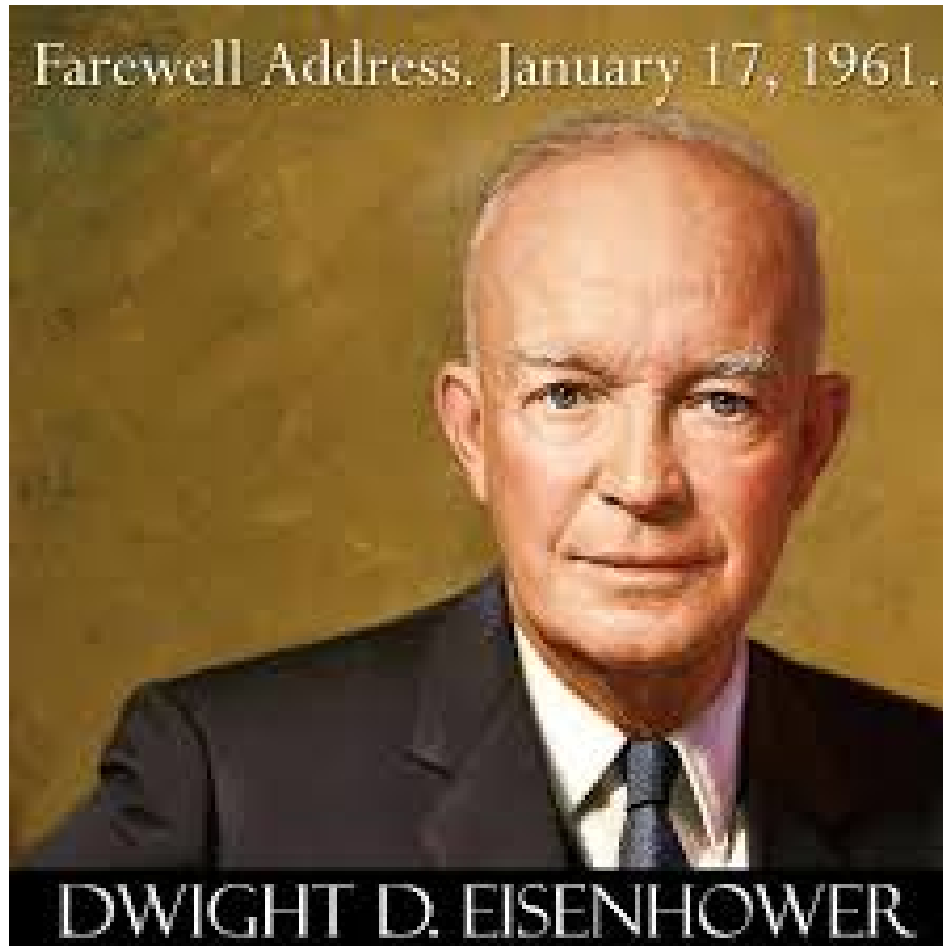

Figure 12.25: “In the councils of government, we must guard against the acquisition of unwarranted influence, whether sought or unsought, by the Military-industrial complex. The potential for the disastrous rise of misplaced power exists and will persist.”

12.13 The nuclear arms race

Flaws in the concept of nuclear deterrence

Before discussing other defects in the concept of deterrence, it must be said very clearly that the idea of “massive nuclear retaliation” is completely unacceptable from an ethical point of view. The doctrine of retaliation, performed on a massive scale, violates not only the principles of common human decency and common sense, but also the ethical principles of every major religion. Retaliation is especially contrary to the central commandment of Christianity which tells us to love our neighbor, even if he or she is far away from us, belonging to a different ethnic or political group, and even if our distant neighbor has seriously injured us. This principle has a fundamental place not only in Christianity but also in all other major religions. “Massive retaliation” completely violates these very central ethical principles, which are not only clearly stated and fundamental but also very practical, since they prevent escalatory cycles of revenge and counter-revenge.

Contrast Christian ethics with estimates of the number of deaths that would follow a US nuclear strike against Russia: Several hundred million deaths. These horrifying estimates shock us not only because of the enormous magnitude of the expected mortality, but also because the victims would include people of every kind: women, men, old people, children and infants, completely irrespective of any degree of guilt that they might have. As a result of such an attack, many millions of people in neutral countries would also die. This type of killing has to be classified as genocide.

When a suspected criminal is tried for a wrongdoing, great efforts are devoted to clarifying the question of guilt or innocence. Punishment only follows if guilt can be proved beyond any reasonable doubt. Contrast this with the totally indiscriminate mass slaughter that results from a nuclear attack!

It might be objected that disregard for the guilt or innocence of victims is a universal characteristic of modern war, since statistics show that, with time, a larger and larger percentage of the victims have been civilians, and especially children. For example, the air attacks on Coventry during World War II, or the fire bombings of Dresden and Tokyo, produced massive casualties which involved all segments of the population with complete disregard for the question of guilt or innocence. The answer, I think, is that modern war has become generally unacceptable from an ethical point of view, and this unacceptability is epitomized in nuclear weapons.

The enormous and indiscriminate destruction produced by nuclear weapons formed the background for an historic 1996 decision by the International Court of Justice in the Hague. In response to questions put to it by WHO and the UN General Assembly, the Court ruled that “the threat and use of nuclear weapons would generally be contrary to the rules of international law applicable in armed conflict, and particularly the principles and rules of Humanitarian law.”

The only *possible* exception to this general rule might be “an extreme circumstance of self-defense, in which the very survival of a state would be at stake”. But the Court refused to say that even in this extreme circumstance the threat or use of nuclear weapons



would be legal. It left the exceptional case undecided. In addition, the World Court added unanimously that “there exists an obligation to pursue in good faith *and bring to a conclusion* negotiations leading to nuclear disarmament in all its aspects under strict international control.”

This landmark decision has been criticized by the nuclear weapon states as being decided “by a narrow margin”, but the structuring of the vote made the margin seem more narrow than it actually was. Seven judges voted against Paragraph 2E of the decision (the paragraph which states that the threat or use of nuclear weapons would be generally illegal, but which mentions as a possible exception the case where a nation might be defending itself from an attack that threatened its very existence.) Seven judges voted for the paragraph, with the President of the Court, Muhammad Bedjaoui of Algeria casting the deciding vote. Thus the Court adopted it, seemingly by a narrow margin. But three of the judges who voted against 2E did so because they believed that no possible exception should be mentioned! Thus, if the vote had been slightly differently structured, the result would have been ten to four.

Of the remaining four judges who cast dissenting votes, three represented nuclear weapons states, while the fourth thought that the Court ought not to have accepted the questions from WHO and the UN. However Judge Schwebel from the United States, who voted against Paragraph 2E, nevertheless added, in a separate opinion, “It cannot be accepted that the use of nuclear weapons on a scale which would - or could - result in the deaths of many millions in indiscriminate inferno and by far-reaching fallout, have pernicious effects in space and time, and render uninhabitable much of the earth, could be lawful.” Judge Higgins from the UK, the first woman judge in the history of the Court, had problems with the word “generally” in Paragraph 2E and therefore voted against it, but she thought that a more profound analysis might have led the Court to conclude in favor of illegality in all circumstances. Judge Fleischhauer of Germany said in his separate

opinion, “The nuclear weapon is, in many ways, the negation of the humanitarian considerations underlying the law applicable in armed conflict and the principle of neutrality. The nuclear weapon cannot distinguish between civilian and military targets. It causes immeasurable suffering. The radiation released by it is unable to respect the territorial integrity of neutral States.”

President Bedjaoui, summarizing the majority opinion, called nuclear weapons “the ultimate evil”, and said “By its nature, the nuclear weapon, this blind weapon, destabilizes Humanitarian law, the law of discrimination in the use of weapons... The ultimate aim of every action in the field of nuclear arms will always be nuclear disarmament, an aim which is no longer utopian and which all have a duty to pursue more actively than ever.”

Thus the concept of nuclear deterrence is not only unacceptable from the standpoint of ethics; it is also contrary to international law. The World Court’s 1996 advisory Opinion unquestionably also represents the opinion of the majority of the world’s peoples. Although no formal plebiscite has been taken, the votes in numerous resolutions of the UN General Assembly speak very clearly on this question. For example the New Agenda Resolution (53/77Y) was adopted by the General Assembly on 4 December 1998 by a massively affirmative vote, in which only 18 out of the 170 member states voted against the resolution.⁷ The New Agenda Resolution proposes numerous practical steps towards complete nuclear disarmament, and it calls on the Nuclear-Weapon States “to demonstrate an unequivocal commitment to the speedy and total elimination of their nuclear weapons and without delay to pursue in good faith and bring to a conclusion negotiations leading to the elimination of these weapons, thereby fulfilling their obligations under Article VI of the Treaty on the Non-Proliferation of Nuclear Weapons (NPT)”. Thus, in addition to being ethically unacceptable and contrary to international law, nuclear weapons also contrary to the principles of democracy.

Having said these important things, we can now turn to some of the other defects in the concept of nuclear deterrence. One important defect is that nuclear war may occur through accident or miscalculation - through technical defects or human failings. This possibility is made greater by the fact that despite the end of the Cold War, thousands of missiles carrying nuclear warheads are still kept on a “hair-trigger” state of alert with a quasi-automatic reaction time measured in minutes. There is a constant danger that a nuclear war will be triggered by error in evaluating the signal on a radar screen. For example, the BBC reported recently that a group of scientists and military leaders are worried that a small asteroid entering the earths atmosphere and exploding could trigger a nuclear war if mistaken for a missile strike.

A number of prominent political and military figures (many of whom have ample knowledge of the system of deterrence, having been part of it) have expressed concern about the danger of accidental nuclear war. Colin S. Grey⁸ expressed this concern as follows: “The problem, indeed the enduring problem, is that we are resting our future upon a nuclear

⁷Of the 18 countries that voted against the New Agenda resolution, 10 were Eastern European countries hoping for acceptance into NATO, whose votes seem to have been traded for increased probability of acceptance.

⁸Chairman, National Institute for Public Policy

deterrence system concerning which we cannot tolerate even a single malfunction.” General Curtis E. LeMay⁹ has written, “In my opinion a general war will grow through a series of political miscalculations and accidents rather than through any deliberate attack by either side.” Bruce G. Blair¹⁰ has remarked that “It is obvious that the rushed nature of the process, from warning to decision to action, risks causing a catastrophic mistake.”... “This system is an accident waiting to happen.”

“But nobody can predict that the fatal accident or unauthorized act will never happen”, Fred Ikle of the Rand Corporation has written, “Given the huge and far-flung missile forces, ready to be launched from land and sea on both sides, the scope for disaster by accident is immense... In a matter of seconds - through technical accident or human failure - mutual deterrence might thus collapse.”

Another serious failure of the concept of nuclear deterrence is that it does not take into account the possibility that atomic bombs may be used by terrorists. Indeed, the threat of nuclear terrorism has today become one of the most pressing dangers that the world faces, a danger that is particularly acute in the United States.

Since 1945, more than 3,000 metric tons (3,000,000 kilograms) of highly enriched uranium and plutonium have been produced - enough for several hundred thousand nuclear weapons. Of this, roughly a million kilograms are in Russia, inadequately guarded, in establishments where the technicians are poorly paid and vulnerable to the temptations of bribery. There is a continuing danger that these fissile materials will fall into the hands of terrorists, or organized criminals, or irresponsible governments. Also, an extensive black market for fissile materials, nuclear weapons components etc. has recently been revealed in connection with the confessions of Pakistan’s bomb-maker, Dr. A.Q. Khan. Furthermore, if Pakistan’s less-than-stable government should be overthrown, complete nuclear weapons could fall into the hands of terrorists.

On November 3, 2003, Mohamed ElBaradei, Director General of the International Atomic Energy Agency, made a speech to the United Nations in which he called for “limiting the processing of weapons-usable material (separated plutonium and high enriched uranium) in civilian nuclear programmes - as well as the production of new material through reprocessing and enrichment - by agreeing to restrict these operations to facilities exclusively under international control.” It is almost incredible, considering the dangers of nuclear proliferation and nuclear terrorism, that such restrictions were not imposed long ago. Nuclear reactors used for “peaceful” purposes unfortunately also generate fissionable isotopes of plutonium, neptunium and americium. Thus all nuclear reactors must be regarded as ambiguous in function, and all must be put under strict international control. One might ask, in fact, whether globally widespread use of nuclear energy is worth the danger that it entails.

The Italian nuclear physicist Francesco Calogero, who has studied the matter closely, believes that terrorists could easily construct a simple gun-type nuclear bomb if they were in possession of a critical mass of highly enriched uranium. In such a simple atomic bomb,

⁹Founder and former Commander in Chief of the United States Strategic Air Command

¹⁰Brookings Institute

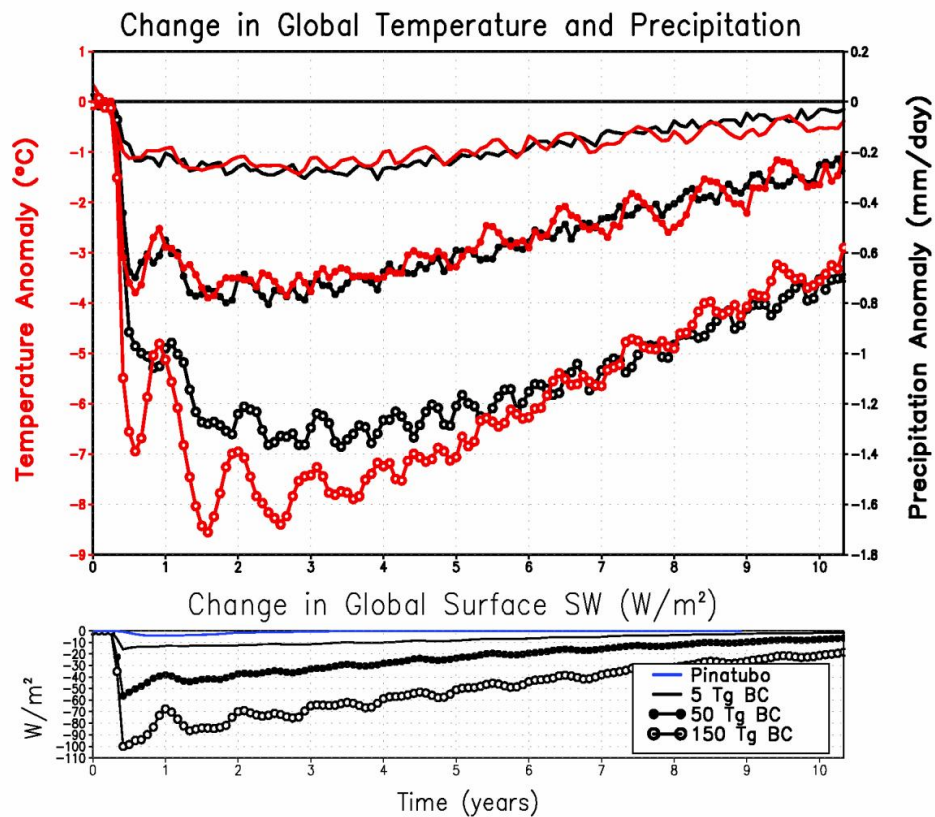

Figure 12.26: Recent studies by atmospheric scientists have shown that the smoke from burning cities produced by even a limited nuclear war would have a devastating effect on global agriculture. The studies show that the smoke would rise to the stratosphere, where it would spread globally and remain for a decade, blocking sunlight and destroying the ozone layer. Because of the devastating effect on global agriculture, darkness from even a small nuclear war (e.g. between India and Pakistan) would result in an estimated billion deaths from famine. Nuclear darkness resulting from a large-scale war involving all of the nuclear weapons that are now on high alert status would destroy all agriculture on earth for a period of ten years, and almost all humans would die of starvation. (See O. Toon , A. Robock, and R. Turco, “The Environmental Consequences of Nuclear War”, *Physics Today*, vol. 61, No. 12, 2008, p. 37-42).

two grapefruit-sized subcritical portions of HEU are placed at opposite ends of the barrel of an artillery piece and are driven together by means of a conventional explosive. Prof. Calogero estimates that the fatalities produced by the explosion of such a device in the center of a large city could exceed 100,000.

We must remember the remark of U.N. Secretary General Kofi Annan after the 9/11/2001 attacks on the World Trade Center. He said, “*This time* it was not a nuclear explosion”. The meaning of his remark is clear: If the world does not take strong steps to eliminate fissionable materials and nuclear weapons, it will only be a matter of time before they will be used in terrorist attacks on major cities. Neither terrorists nor organized criminals can be deterred by the threat of nuclear retaliation, since they have no territory against which such retaliation could be directed. They blend invisibly into the general population. Nor can a “missile defense system” prevent terrorists from using nuclear weapons, since the weapons can be brought into a port in any one of the hundreds of thousands of containers that enter on ships each year, a number far too large to be checked exhaustively.

Today we must give special weight to the danger that a catastrophic nuclear war may occur through the mental instability of a political leader or an error of judgement, since we now are living with Donald Trump and Kim Jong-un. In the words of ICAN’s Executive Director Beatrice Finn, the end of human civilization and much of the biosphere is “only a tantrum away”. Donald Trump has repeatedly expressed his desire for more “usable” nuclear weapons. and if nuclear weapons are ever used, there is a strong danger of escalation to a full-scale thermonuclear war.

Another problem with the concept of nuclear deterrence is that even if the danger that a catastrophic nuclear war will occur in any given year is small, over a long period of time the danger builds up into a certainty. If the dangers for any given year are 1%, 2% or 3%, the probabilities of are survival until 2100 are respectively 43%, 18% and 8%. If the period for which we must survive is extended to the year 2200, the chances of survival in the three cases are respectively .16%, .025%, and .0039%.

In this perilous situation, the only logical thing for the world to do is to get rid of both fissile materials and nuclear weapons as rapidly as possible. We must acknowledge that the idea of nuclear deterrence is a dangerous fallacy, and acknowledge that the development of military systems based on nuclear weapons has been a terrible mistake, a false step that needs to be reversed. If the most prestigious of the nuclear weapons states can sincerely acknowledge their mistakes and begin to reverse them, nuclear weapons will seem less glamorous to countries like India, Pakistan, North Korea and Iran, where they now are symbols of national pride and modernism.

Civilians have for too long played the role of passive targets, hostages in the power struggles of politicians. It is time for civil society to make its will felt. If our leaders continue to enthusiastically support the institution of war, if they will not abolish nuclear weapons, then let us have new leaders.

12.14 Global famine produced by nuclear war

The danger of a catastrophic nuclear war casts a dark shadow over the future of our species. It also casts a very black shadow over the future of the global environment. The environmental consequences of a massive exchange of nuclear weapons have been treated in a number of studies by meteorologists and other experts from both East and West. They predict that a large-scale use of nuclear weapons would result in fire storms with very high winds and high temperatures, which would burn a large proportion of the wild land fuels in the affected nations. The resulting smoke and dust would block out sunlight for a period of many months, at first only in the northern hemisphere but later also in the southern hemisphere.

Temperatures in many places would fall far below freezing, and much of the earth's plant life would be killed. Animals and humans would then die of starvation. The nuclear winter effect was first discovered as a result of the Mariner 9 spacecraft exploration of Mars in 1971. The spacecraft arrived in the middle of an enormous dust-storm on Mars, and measured a large temperature drop at the surface of the planet, accompanied by a heating of the upper atmosphere. These measurements allowed scientists to check their theoretical models for predicting the effect of dust and other pollutants distributed in planetary atmospheres.

Using experience gained from the studies of Mars, R.P. Turco, O.B. Toon, T. Ackerman, J.B. Pollack and C. Sagan made a computer study of the climatic effects of the smoke and dust that would result from a large-scale nuclear war. This early research project is sometimes called the TTAPS Study, after the initials of the authors.

In April 1983, a special meeting was held in Cambridge, Massachusetts, where the results of the TTAPS Study and other independent studies of the nuclear winter effect were discussed by more than 100 experts. Their conclusions were presented at a forum in Washington, D.C., the following December, under the chairmanship of U.S. Senators Kennedy and Hatfield. The numerous independent studies of the nuclear winter effect all agreed of the following main predictions:

High-yield nuclear weapons exploded near the earth's surface would put large amounts of dust into the upper atmosphere. Nuclear weapons exploded over cities, forests, oilfields and refineries would produce fire storms of the type experienced in Dresden and Hamburg after incendiary bombings during the Second World War. The combination of high-altitude dust and lower altitude soot would prevent sunlight from reaching the earth's surface, and the degree of obscuration would be extremely high for a wide range of scenarios.

A baseline scenario used by the TTAPS study assumes a 5,000-megaton nuclear exchange, but the threshold for triggering the nuclear winter effect is believed to be much lower than that. After such an exchange, the screening effect of pollutants in the atmosphere might be so great that, in the northern and middle latitudes, the sunlight reaching the earth would be only 1% of ordinary sunlight on a clear day, and this effect would persist for many months. As a result, the upper layers in the atmosphere might rise in temperature by as much as 100 °C, while the surface temperatures would fall, perhaps by as much as 50 °C.

The temperature inversion produced in this way would lead to superstability, a condition in which the normal mixing of atmospheric layers is suppressed. The hydrological cycle (which normally takes moist air from the oceans to a higher and cooler level, where the moisture condenses as rain) would be strongly suppressed. Severe droughts would thus take place over continental land masses. The normal cleansing action of rain would be absent in the atmosphere, an effect which would prolong the nuclear winter.

In the northern hemisphere, forests would die because of lack of sunlight, extreme cold, and drought. Although the temperature drop in the southern hemisphere would be less severe, it might still be sufficient to kill a large portion of the tropical forests, which normally help to renew the earth's oxygen.

The oxygen content of the atmosphere would then fall dangerously, while the concentration of carbon dioxide and oxides of nitrogen produced by firestorms would remain high. The oxides of nitrogen would ultimately diffuse to the upper atmosphere, where they would destroy the ozone layer.

Thus, even when the sunlight returned after an absence of many months, it would be sunlight containing a large proportion of the ultraviolet frequencies which are normally absorbed by the ozone in the stratosphere, and therefore a type of light dangerous to life. Finally, after being so severely disturbed, there is no guarantee that the global climate would return to its normal equilibrium.

Even a nuclear war below the threshold of nuclear winter might have climatic effects very damaging to human life. Professor Paul Ehrlich, of Stanford University, has expressed this in the following words:

"...A smaller war, which set off fewer fires and put less dust into the atmosphere, could easily depress temperatures enough to essentially cancel grain production in the northern hemisphere. That in itself would be the greatest catastrophe ever delivered upon Homo Sapiens, just that one thing, not worrying about prompt effects. Thus even below the threshold, one cannot think of survival of a nuclear war as just being able to stand up after the bomb has gone off."¹¹

¹¹<http://www.voanews.com/content/pope-francis-calls-for-nuclear-weapons-ban/2909357.html>
<http://www.cadmusjournal.org/article/issue-4/flaws-concept-nuclear-deterrence>
<http://www.countercurrents.org/avery300713.htm>
<https://www.wagingpeace.org/author/john-avery/>
<http://www.commondreams.org/news/2015/08/06/70-years-after-bombing-hiroshima-calls-abolish-nuclear-weapons>
<http://www.informationclearinghouse.info/article42488.htm>
<http://www.informationclearinghouse.info/article42492.htm>
<http://www.commondreams.org/views/2015/08/06/hiroshima-and-nagasaki-remembering-power>
<http://human-wrongs-watch.net/2015/07/22/israel-iran-and-the-nuclear-non-proliferation-treaty/>
<http://human-wrongs-watch.net/2015/06/25/militarisms-hostages/>
<http://human-wrongs-watch.net/2015/05/24/the-path-to-zero-dialogues-on-nuclear-dangers-by-richard-falk-and-david-krieger/>
<http://human-wrongs-watch.net/2015/03/30/europe-must-not-be-forced-into-a-nuclear-war-with-russia/>
<http://www.truth-out.org/opinion/item/32073-the-us-should-eliminate-its-nuclear-arsenal-not-modernize-it>
<http://www.cadmusjournal.org/article/issue-4/flaws-concept-nuclear-deterrence>

A 2012 report published by International Physicians for the Prevention of Nuclear War states that even a small local nuclear war between India and Pakistan would put two billion people at risk of starvation.

12.15 Military-industrial complexes today

“We’re going to take out seven countries in five years”

In an interview with Amy Goodman¹², retired 4-star General Wesley Clark said: “About ten days after 9/11, I went through the Pentagon and I saw Secretary Rumsfeld and Deputy Secretary Wolfowitz. I went downstairs just to say hello to some of the people on the Joint Staff who used to work for me, any one of the generals called me in. He said, “Sir, you’ve got to come in and talk to me a second.” I said, “Well, you’re too busy.” He said, “No, no.” He says, “We’ve made the decision we’re going to war with Iraq.” This was on or about the 20th of September. I said, “We’re going to war with Iraq? Why?” He said, “I don’t know.” He said, “I guess they don’t know what else to do.” So I said, “Well, did they find some information connecting Saddam to al-Qaeda?” He said, “No, no.” He says, “There’s nothing new that way. They just made the decision to go to war with Iraq.” He said, “I guess it’s like we don’t know what to do about terrorists, but we’ve got a good military and we can take down governments.” And he said, “I guess if the only tool you have is a hammer, every problem has to look like a nail.

So I came back to see him a few weeks later, and by that time we were bombing in Afghanistan. I said, “Are we still going to war with Iraq?” And he said, “Oh, it’s worse than that.” He reached over on his desk. He picked up a piece of paper. And he said, “I just got this down from upstairs” - meaning the Secretary of Defense’s office - “today.” And he said, “This is a memo that describes how we’re going to take out seven countries in five years, starting with Iraq, and then Syria, Lebanon, Libya, Somalia, Sudan and, finishing off, Iran.” I said, “Is it classified?” He said, “Yes, sir.” I said, “Well, don’t show it to me.” And I saw him a year or so ago, and I said, “You remember that?” He said, “Sir, I didn’t show you that memo! I didn’t show it to you!”

<http://www.cadmusjournal.org/article/issue-6/arms-trade-treaty-opens-new-possibilities-u>

<http://eruditio.worldacademy.org/issue-6/article/remember-your-humanity>

<http://www.informationclearinghouse.info/article42568.htm>

<https://firstlook.org/theintercept/2014/09/23/nobel-peace-prize-fact-day-syria-7th-country-bombed-obama/>

<http://www.informationclearinghouse.info/article42577.htm>

<http://www.informationclearinghouse.info/article42580.htm>

<http://human-wrongs-watch.net/2015/08/06/us-unleashing-of-atomic-weapons-against-civilian-populations-was-a-criminal-act-of-the-first-order/>

<http://human-wrongs-watch.net/2015/08/06/hiroshima-and-nagasaki-remembering-the-power-of-peace/>

<http://human-wrongs-watch.net/2015/08/04/atomic-bombing-hear-the-story-setsuko-thurlow/>

<http://human-wrongs-watch.net/2015/08/04/atomic-bombing-hear-the-story-yasuaki-yamashita/>

<http://human-wrongs-watch.net/2015/08/03/why-nuclear-weapons/>

¹²<https://genius.com/General-wesley-clark-seven-countries-in-five-years-annotated>

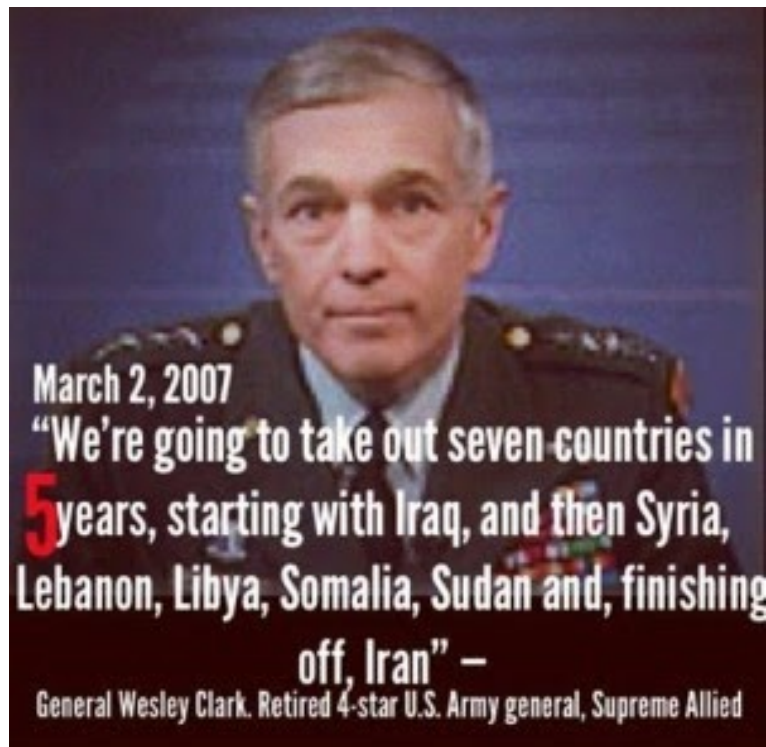

Figure 12.27: General Wesley Clark

The global trade in light arms

An important poverty-generating factor in the developing countries is war - often civil war. The five permanent members of the U.N. Security Council are, ironically, the five largest exporters of small arms. Small arms have a long life. The weapons poured into Africa by both sides during the Cold War are still there, and they contribute to political chaos and civil wars that block development and cause enormous human suffering.

The United Nations website on Peace and Security through Disarmament states that “Small arms and light weapons destabilize regions; spark, fuel and prolong conflicts; obstruct relief programmes; undermine peace initiatives; exacerbate human rights abuses; hamper development; and foster a ‘culture of violence’.”

An estimated 639 million small arms and light weapons are in circulation worldwide, one for every ten people. Approximately 300,000 people are killed every year by these weapons, many of them women and children.

Examples of endemic conflict

In several regions of Africa, long-lasting conflicts have prevented development and caused enormous human misery. These regions include Ethiopia, Eritria, Somalia (Darfur), Chad, Zimbabwe and the Democratic Republic of Congo. In the Congo, the death toll reached 5.4 million in 2008, with most of the victims dying of disease and starvation, but with war



Figure 12.28: 40,000 children die each day from starvation or from poverty-related diseases. Meanwhile, the world spends more than \$1,700,000,000,000 each year on armaments.

as the root cause. In view of these statistics, the international community can be seen to have a strong responsibility to stop supplying small arms and ammunition to regions of conflict. There is absolutely no excuse for the large-scale manufacture and international sale of small arms that exists today.

The Wolfowitz Doctrine

The Wolfowitz Doctrine is the unofficial name given to the early version of the Defense Strategy for the 1990s: The Regional Defense Strategy report for the 1994-99 fiscal years. It was later released by then Secretary of Defense Dick Cheney in 1993. It brazenly advocates that America do everything in its power to retain its global hegemony and superpower status, including ensuring that Russia, China, Iran and other regional powers - but especially Russia - be prevented from attaining enough power to seriously challenge the US. In short, it's another US blueprint for total global supremacy.

There are many quotable passages from the Wolfowitz Doctrine. Here's one which sums up its aims:

“Our first objective is to prevent the re-emergence of a new rival, either on the territory of the former Soviet Union or elsewhere that poses a threat on the order of that posed formerly by the Soviet Union. This is a dominant consideration underlying the new regional defense strategy and requires that we endeavor to prevent any hostile power from dominating a region whose resources would, under consolidated control, be sufficient to generate global power. These regions include Western Europe, East Asia, the territory of the former Soviet Union, and Southwest Asia.”

Similar motives guide US policy today. In February, 2018, US Secretary of Defense James Mattis said: “We will continue to prosecute the campaign against terrorists, but great-power competition - not terrorism - is now the primary focus of US national security.”

Militarism in North Korea

The following states are now believed to currently possess nuclear weapons: The United States, Russia, The United Kingdom, France, China, India, Pakistan, North Korea and Israel. The way in which North Korea obtained its nuclear weapons is described by Wikipedia in the following paragraphs:

“The nuclear program can be traced back to about 1962, when North Korea committed itself to what it called ‘all-fortressization’, which was the beginning of the hyper-militarized North Korea of today. In 1963, North Korea asked the Soviet Union for help in developing nuclear weapons, but was refused. The Soviet Union agreed to help North Korea develop a peaceful nuclear energy program, including the training of nuclear scientists. Later, China, after its nuclear tests, similarly rejected North Korean requests for help with developing nuclear weapons.

“Soviet engineers took part in the construction of the Yongbyon Nuclear Scientific Research Center and began construction of an IRT-2000 research reactor in 1963, which

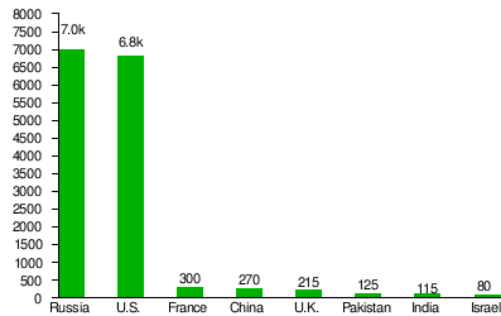

Figure 12.29: Countries by estimated nuclear warhead stockpiles according to the Federation of American scientists.



Figure 12.30: North Korea's dictator, Kim Jong-un. The doctrine of nuclear deterrence rests on the assumption that political leaders will always act rationally, an assumption that seems very uncertain in the case of the U.S.-North Korean conflict.

became operational in 1965 and was upgraded to 8 MW in 1974. In 1979 North Korea indigenously began to build in Yongbyon a second research reactor, an ore processing plant and a fuel rod fabrication plant. Soviet engineers took part in the construction of the Yongbyon Nuclear Scientific Research Center, and began construction of an IRT-2000 research reactor in 1963, which became operational in 1965 and was upgraded to 8 MW in 1974. In 1979 North Korea indigenously began to build in Yongbyon a second research reactor, an ore processing plant and a fuel rod fabrication plant. ”

Thus like other new nuclear weapons states, North Korea obtained nuclear weapons by misuse of nuclear power generation facilities donated by other countries. In addition, North Korea spend a large fraction of its GDP on conventional armaments. Under the Songun policy, the Korean Peoples Army is the central institution of North Korean society. As of 2016, the Korean Peoples Army had 5,889,000 paramilitary personelle (25% of the population of North Korea) making it the largest paramilitary organization on earth.

Table 12.1: SIPRI Military Expenditure Database, 2016

| Rank | Country | Annual Spending \$ Bn. | % of GDP |
|------|----------------|---------------------------|----------|
| 1 | United State | 611.2 | 3.3 |
| 2 | China | 215.7 | 1.9 |
| 3 | Russia | 69.2 | 5.3 |
| 4 | Saudi Arabia | 63.7 | 10 |
| 5 | India | 55.9 | 2.5 |
| 6 | France | 55.7 | 2.3 |
| 7 | United Kingdom | 48.3 | 1.9 |
| 8 | Japan | 46.1 | 1.0 |
| 9 | Germany | 41.1 | 1.2 |
| 10 | South Korea | 36.8 | 2.7 |
| 11 | Italy | 27.9 | 1.5 |
| 12 | Australia | 24.3 | 2.0 |

Table 12.2: SIPRI List of arms manufacturers, 2016

| Rank | Company | Country | Annual Arms Sales \$ Mn. |
|------|---------------------------------|----------------|-----------------------------|
| 1 | Lockheed Martin | United States | 40,830 |
| 2 | Boeing | United States | 29,510 |
| 3 | Raytheon | United States | 22,910 |
| 4 | BAE Systems | United Kingdom | 22,700 |
| 5 | Northrop Grumman | United States | 21,400 |
| 6 | General Dynamics | United States | 19,230 |
| 7 | Airbus | European Union | 12,520 |
| 8 | L-3 Communications | United States | 8,890 |
| 9 | Leonardo-Finmeccanica | Italy | 8,500 |
| 10 | Thales Group | France | 8,170 |
| 11 | United Technologies Corporation | United States | 6,870 |
| 12 | Huntington Ingalls Industries | United States | 6,720 |

The SIPRI Yearbook, 2017

Dan Smith of the Stockholm International Peace Research Institute (SIPRI) wrote the following Introduction to the organization's yearbook for 2017:

“An overall perspective on 2016 finds a balance between negative developments and the continued functioning of the international system. However, the year ended with clear grounds for concern that the balance sheet seemed to be tipping towards the negative amid growing unease about the durability of key parts of the international security architecture.

“Conflicts in the Middle East continued to generate humanitarian tragedies and large-scale movement of refugees, and violent conflict continued in several other parts of the world, most notably Africa, Asia and to a lesser extent Eastern Europe. Developments in North Korea's nuclear programme contributed to international political instability with potentially serious knock-on effects. On the positive side, the 2015 Paris Climate Agreement entered into force in November 2016, the 2015 Iran nuclear deal began implementation on time in early 2016 and the United Nations General Assembly adopted a resolution to start negotiations in 2017 on eliminating nuclear weapons. Progress was also made on work to monitor the unfolding implementation of the UN's Agenda 2030 for international social and economic development. A major contribution to the positive side of the balance sheet in 2016 was the peace agreement in Colombia.

“Nonetheless, virtually all the major global indicators for peace and security have moved in a negative direction: more military spending, increased arms trading, more violent conflicts and the continuing forward march of military technology.

“Existing multilateral and bilateral arms control agreements and processes are also under challenge-not least due to the deteriorating relationship between Russia and the United States-raising questions of global concern and potentially epochal scope. Were the great gains in peaceful relations since the end of the cold war now being reversed? Would the return of strategic competition between the major powers have negative implications for managing increased conflict risk? These uncertainties, combined with political developments in Europe and the USA- especially the vote by the United Kingdom to leave the European Union and the election of Donald J. Trump as US President-seemed to reveal a much decreased commitment to international institutions and a renewed emphasis in several key states on a narrowly defined national interest.

“The scale of the challenges facing humanity has been summed up in the proposal to adopt the label of ‘the Anthropocene’ for the current era, thus designating it as one in which human activity is the dominant influence on climate and the environment. It is disconcerting to note that such cooperation risks becoming more elusive than it has seemed for most of the time since the end of the cold war, at a time when it is more needed than ever. Experience has shown that international cooperation can work. But is the international cooperative urge as persistent as the problems it needs to address?”



Figure 12.31: Tom Cruise in “Top Gun”.



Figure 12.32: A culture of violence supports the Devil’s Dynamo.

12.16 A culture of violence

Links with the entertainment industry

Here are a few films that glorify war:

- Black Hawk Down
- Top Gun
- Behind Enemy Lines
- Red Dawn (1984)
- American Sniper
- Iron Eagle
- Pearl Harbor

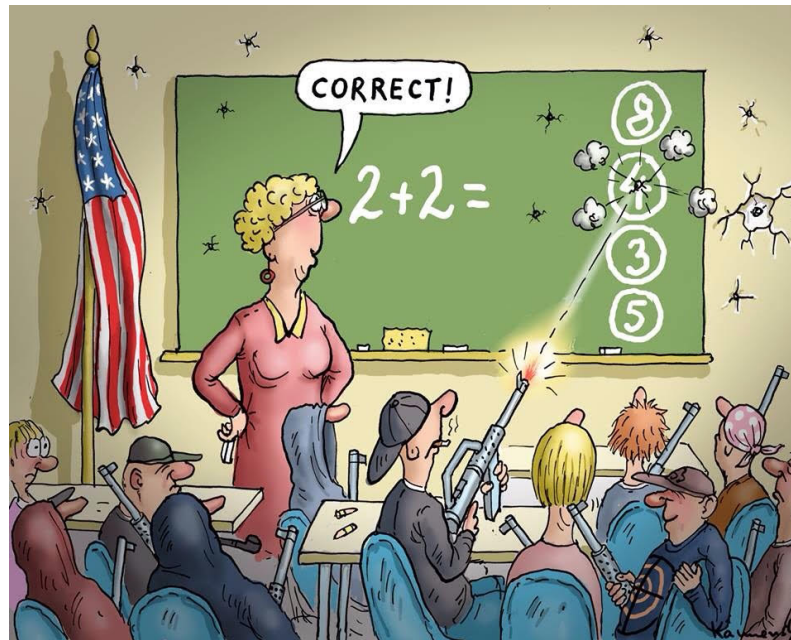

Figure 12.33: **A culture of violence:** In the United States the National Rifle Association has proposed guns in schools as the answer to the epidemic of school shootings.

- Act of Valor
- We Were Soldiers
- The Green Berets

Making a game of killing

The mass media are an important part of our educational system. Perhaps it is time to look more closely at the values that they are transmitting. In particular, we should perhaps look at computer games designed for young boys. They often give the strongest imaginable support to a culture of violence.

For example, a game entitled “Full Spectrum Warrior” was recently reviewed in a Danish newspaper. According to the reviewer, “...An almost perfect combination of graphics, sound, band design, and gameplay makes it seem exactly like the film *Black Hawk Down* - with the player as the main character. This is not just a coincidence, because the game is based on an army training program... Full Spectrum Warrior is an extremely intense experience, and despite the advanced possibilities, the controls are simple enough so that young children can play it... The player is completely drawn into the screen, and remains there until the end of the mission.” The reviewer gave the game six stars (the maximum).

Another genre of computer games has to do with building empires, ignoring the fact that imperialism is morally indefensible. For example, “Forge of Empires” is a browser-based strategy game. It is described as follows: “The game offers a single-player campaign

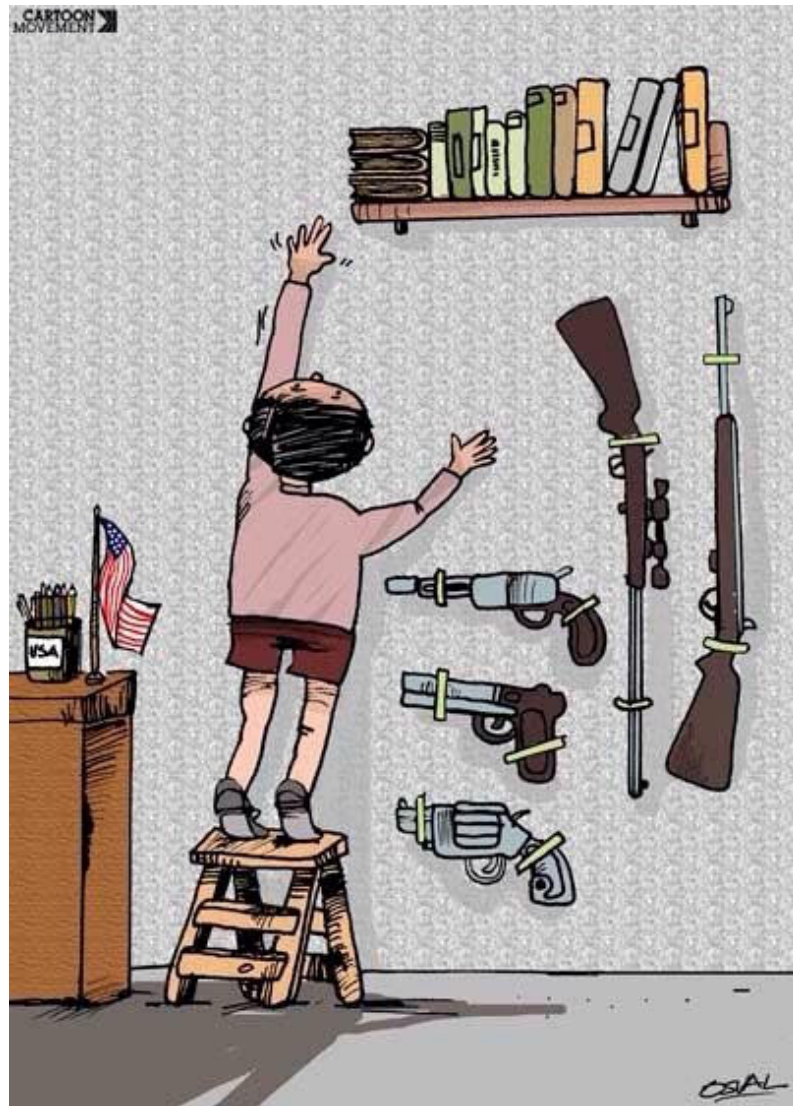

Figure 12.34: A culture of violence. Guns in schools?

for players to explore and conquer several provinces, gaining resources and new technology as they progress.” Conquering countries for the sake of gaining their resources is an all-too-familiar feature of the modern world. In the game “Forge of Empires”, our young people are indoctrinated with the ethos of resource wars.

During his trial, the Norwegian mass-murderer Anders Behring Breivik described how he trained for his attack on young people on the Island of Utøya using the computer game “Call of Duty: Modern Warfare”. The court also heard how he took what he called a “sabbatical” for a year between the summers of 2006 and 2007. During this year, he played a game called “World of Warcraft” full-time, in the bedroom of his mother’s Oslo flat, spending up to 16 hours a day using the game to distance himself from the human and moral significance of killing.

Is this not similar to the frame of mind of drone operators, sitting in comfort in their Nevada bunkers, distanced from the reality of killing? They are playing a computer game that kills targeted individuals and their families, in remote countries, by remote control. There is no need to look into the eyes of the victims. They are just abstract symbols in a computer game.

12.17 The threats and costs of war

In the long run, because of the enormously destructive weapons, which have been produced through the misuse of science, the survival of civilization can only be insured if we are able to abolish the institution of war.

Modern warfare has become prohibitively dangerous and destructive because of the enormously powerful weapons that scientists and engineers have developed. The institution of war could not continue without their cooperation. Thus, scientists and engineers throughout the world have a special responsibility.

Wars are driven by the collective paranoia of voters, who are willing to allow colossal sums to be spent by ‘Defense Departments’. But are civilians really defended? Absolutely not!

We can see this most clearly if we think of nuclear war. Nations threaten each other with “Mutually Assured Destruction”, which has the very appropriate acronym MAD. What does this mean? Does it mean that civilians are being protected? Not at all. Instead they are threatened with complete destruction. Civilians here play the role of hostages in the power games of their leaders. Those leaders’ goal is not protection of ordinary people, but rather protection of the gargantuan profits of the military-industrial complex. As the Indian writer Arundhati Roy put it, “Once weapons were manufactured to fight wars. Now wars are manufactured to sell weapons.”

If a thermonuclear war occurs, it will be the end of human civilization and much of the biosphere. This will definitely happen in the future unless the world rids itself of nuclear weapons, since, in the long run, the finite chance of accidental nuclear war happening due to a technical or human failure during a given year will gradually build up into a certainty of disaster. Scientists and engineers must not sell their knowledge and talents to this march



Figure 12.35: Children born with birth defects due to the US use of Agent Orange during the Vietnam War. Source: stopwarcoalition.org

towards the precipice.

The direct and indirect costs of war

The costs of war, both direct and indirect, are so enormous that they are almost beyond comprehension. We face a direct threat because a thermonuclear war may destroy human civilization and much of the biosphere, and an indirect threat because the institution of war interferes seriously with the use of tax money for constructive and peaceful purposes.

Today, despite the end of the Cold War, the world spends roughly 1.7 trillion (i.e. 1.7 million million) US dollars each year on armaments. This colossal flood of money could have been used instead for education, famine relief, development of infrastructure, or on urgently needed public health measures.

The World Health Organization lacks funds to carry through an antimalarial program on as large a scale as would be desirable, but the entire program could be financed for less than our military establishments spend in a single day. Five hours of world arms spending is equivalent to the total cost of the 20-year WHO campaign that resulted in the eradication of smallpox. For every 100,000 people in the world, there are 556 soldiers, but only 85 doctors. Every soldier costs an average of \$20,000 per year, while the average spent on education is only \$380 per school-aged child. With a diversion of funds consumed by three weeks of military spending, the world could create a sanitary water supply for all its people, thus eliminating the cause of almost half of all human illness.

A new drug-resistant form of tuberculosis has recently become widespread in Asia and in the former Soviet Union. In order to combat this new and highly dangerous form of tuberculosis and to prevent its spread, WHO needs \$500 million, an amount equivalent to 1.2 hours of world arms spending.

Today's world is one in which roughly ten million children die every year from starvation or from diseases related to poverty. Besides this enormous waste of young lives through malnutrition and preventable disease, there is a huge waste of opportunities through inadequate education. The rate of illiteracy in the 25 least developed countries is 80%, and the total number of illiterates in the world is estimated to be 800 million. Meanwhile every 60 seconds the world spends \$6.5 million on armaments.



Figure 12.36: A little girl cries as medics attend to her injuries at al-Shifa hospital in Gaza in 2014, during the conflict. Photo: UNICEF/Eyad El Baba

It is plain that if the almost unbelievable sums now wasted on the institution of war were used constructively, most of the pressing problems of humanity could be solved, but today the world spends more than 20 times as much on war as it does on development.

Medical and psychological consequences; loss of life

While in earlier epochs it may have been possible to confine the effects of war mainly to combatants, in the 20th century the victims of war were increasingly civilians, and especially children. For example, according to Quincy Wright's statistics, the First and Second World Wars cost the lives of 26 million soldiers, but the toll in civilian lives was much larger: 64 million.

Since the Second World War, despite the best efforts of the UN, there have been over 150 armed conflicts; and, if civil wars are included, there are on any given day an average of 12 wars somewhere in the world. In the conflicts in Indo-China, the proportion of civilian victims was between 80% and 90%, while in the Lebanese civil war some sources state that the proportion of civilian casualties was as high as 97%.

Civilian casualties often occur through malnutrition and through diseases that would be preventable in normal circumstances. Because of the social disruption caused by war, normal supplies of food, safe water and medicine are interrupted, so that populations become vulnerable to famine and epidemics.¹³

¹³<http://www.cadmusjournal.org/article/volume-2/issue-2-part-3/lessons-world-war-i>
<http://www.truth-out.org/opinion/item/27201-the-leading-terrorist-state>



Figure 12.37: Asylum-seekers in a holding centre on Greece's Samos Island.

Effects of war on children

According to UNICEF figures, 90% of the casualties of recent wars have been civilians, and 50% children. The organization estimates that in recent years, violent conflicts have driven 20 million children from their homes. They have become refugees or internally displaced persons within their own countries.

During the last decade 2 million children have been killed and 6 million seriously injured or permanently disabled as the result of armed conflicts, while 1 million children have been orphaned or separated from their families. Of the ten countries with the highest rates of death of children under five years of age, seven are affected by armed conflicts. UNICEF estimates that 300,000 child soldiers are currently forced to fight in 30 armed conflicts throughout the world. Many of these have been forcibly recruited or abducted.

Even when they are not killed or wounded by conflicts, children often experience painful psychological traumas: the violent death of parents or close relatives, separation from their families, seeing family members tortured, displacement from home, disruption of ordinary life, exposure to shelling and other forms of combat, starvation and anxiety about the future.¹⁴

Refugees

Human Rights Watch estimates that in 2001 there were 15 million refugees in the world, forced from their countries by war, civil and political conflict, or by gross violations of human rights. In addition, there were an estimated 22 million internally displaced persons, violently forced from their homes but still within the borders of their countries.

In 2001, 78% of all refugees came from ten areas: Afghanistan, Angola, Burma, Burundi, Congo-Kinshasa, Eritrea, Iraq, the Palestinian territories, Somalia and Sudan. A

¹⁴<http://www.ncbi.nlm.nih.gov/pmc/articles/PMC2080482/>

quarter of all refugees are Palestinians, who make up the world's oldest and largest refugee population. 45% of the world's refugees have found sanctuaries in Asia, 30% in Africa, 19% in Europe and 5% in North America.

Refugees who have crossed an international border are in principle protected by Article 14 of the Universal Declaration of Human Rights, which affirms their right "to seek and to enjoy in other countries asylum from persecution". In 1950 the Office of the High Commissioner for Refugees was created to implement Article 14, and in 1951 the Convention Relating to the Status of Refugees was adopted by the UN. By 2002 this legally binding treaty had been signed by 140 nations. However the industrialized countries have recently adopted a very hostile and restrictive attitude towards refugees, subjecting them to arbitrary arrests, denial of social and economic rights, and even forcible return to countries in which they face persecution.

The status of internally displaced persons is even worse than that of refugees who have crossed international borders. In many cases the international community simply ignores their suffering, reluctant to interfere in the internal affairs of sovereign states. In fact, the United Nations Charter is self-contradictory in this respect, since on the one hand it calls for non-interference in the internal affairs of sovereign states, but on the other hand, people everywhere are guaranteed freedom from persecution by the Charter's Universal Declaration of Human Rights.¹⁵

Damage to infrastructure

Most insurance policies have clauses written in fine print exempting companies from payment of damage caused by war. The reason for this is simple. The damage caused by war is so enormous that insurance companies could never come near to paying for it without going bankrupt.

We mentioned above that the world spends 1.7 trillion dollars each year on preparations for war. A similarly colossal amount is needed to repair the damage to infrastructure caused by war. Sometimes this damage is unintended, but sometimes it is intentional.

During World War II, one of the main aims of air attacks by both sides was to destroy the industrial infrastructure of the opponent. This made some sense in a war expected to last several years, because the aim was to prevent the enemy from producing more munitions. However, during the Gulf War of 1990, the infrastructure of Iraq was attacked, even though the war was expected to be short. Electrical generating plants and water purification facilities were deliberately destroyed with the apparent aim of obtaining leverage over Iraq after the war.

In general, because war has such a catastrophic effect on infrastructure, it can be thought of as the opposite of development. War is the greatest generator of poverty.¹⁶

¹⁵<https://www.hrw.org/topic/refugees>

¹⁶<https://www.wsws.org/en/articles/2002/11/iraq-n04.html>
<http://www.globalresearch.ca/charges-against-humanity-the-destruction-of-iraqs-electricity-infrastructure-the-social-economic-and-environmental-impacts/5355665>
<http://www.afdb.org/fileadmin/uploads/afdb/Documents/Publications/00157630-EN-ERP-48.PDF>



Figure 12.38: Image source: Greenpeace

Ecological damage

Warfare during the 20th century has not only caused the loss of 175 million lives (primarily civilians) - it has also caused the greatest ecological catastrophes in human history. The damage takes place even in times of peace. Studies by Joni Seager, a geographer at the University of Vermont, conclude that “a military presence anywhere in the world is the single most reliable predictor of ecological damage”.

Modern warfare destroys environments to such a degree that it has been described as an “environmental holocaust.” For example, herbicides use in the Vietnam War killed an estimated 6.2 billion board-feet of hardwood trees in the forests north and west of Saigon, according to the American Association for the Advancement of Science. Herbicides such as Agent Orange also made enormous areas of previously fertile land unsuitable for agriculture for many years to come. In Vietnam and elsewhere in the world, valuable agricultural land has also been lost because land mines or the remains of cluster bombs make it too dangerous for farming.

During the Gulf War of 1990, the oil spills amounted to 150 million barrels, 650 times the amount released into the environment by the notorious Exxon Valdez disaster. During the Gulf War an enormous number of shells made of depleted uranium were fired. When the dust produced by exploded shells is inhaled it often produces cancer, and it will remain in the environment of Iraq for decades.

Radioactive fallout from nuclear tests pollutes the global environment and causes many thousands of cases of cancer, as well as birth abnormalities. Most nuclear tests have been carried out on lands belonging to indigenous peoples. Agent Orange also produced cancer, birth abnormalities and other serious forms of illness both in the Vietnamese population and among the foreign soldiers fighting in Vietnam¹⁷

¹⁷<http://www.dailymail.co.uk/news/article-2401378/Agent-Orange-Vietnamese-children-suffering-effects-herbicide-sprayed-US-Army-40-years-ago.html>



Figure 12.39: The 15 megaton explosion detonated by the United States at Bikini Atoll in 1954 produced lasting biological damage to humans and animals living on the distant Marshall Islands. Today, half a century later, the islanders still experience radiation sickness in the form of leukemia and birth defects. Source: www.theguardian.com

12.18 The threat of nuclear war

As bad as conventional arms and conventional weapons may be, it is the possibility of a catastrophic nuclear war that poses the greatest threat to humanity. There are today roughly 16,000 nuclear warheads in the world. The total explosive power of the warheads that exist or that could be made on short notice is approximately equal to 500,000 Hiroshima bombs.

To multiply the tragedy of Hiroshima by a factor of half a million makes an enormous difference, not only quantitatively, but also qualitatively. Those who have studied the question believe that a nuclear catastrophe today would inflict irreversible damage on our civilization, genetic pool and environment.

Thermonuclear weapons consist of an inner core where the fission of uranium-235 or plutonium takes place. The fission reaction in the core is able to start a fusion reaction in the next layer, which contains isotopes of hydrogen. It is possible to add a casing of ordinary uranium outside the hydrogen layer, and under the extreme conditions produced by the fusion reaction, this ordinary uranium can undergo fission. In this way, a fission-fusion-fission bomb of almost limitless power can be produced.

For a victim of severe radiation exposure, the symptoms during the first week are nausea, vomiting, fever, apathy, delirium, diarrhoea, oropharyngeal lesions and leukopenia. Death occurs during the first or second week.

We can perhaps be helped to imagine what a nuclear catastrophe means in human terms by reading the words of a young university professor, who was 2,500 meters from the hypocenter at the time of the bombing of Hiroshima: "Everything I saw made a deep impression: a park nearby covered with dead bodies... very badly injured people evacuated



Figure 12.40: A nuclear war would be an ecological disaster, making large portions of the world permanently uninhabitable because of long-lasting radioactivity. Chernobyl radiation map 1996 30km zone by CIA Factbook. Licensed under CC BY-SA 2.5 via Wikimedia Commons.

in my direction... Perhaps most impressive were girls, very young girls, not only with their clothes torn off, but their skin peeled off as well. ... My immediate thought was that this was like the hell I had always read about. ... I had never seen anything which resembled it before, but I thought that should there be a hell, this was it."

One argument that has been used in favor of nuclear weapons is that no sane political leader would employ them. However, the concept of deterrence ignores the possibility of war by accident or miscalculation, a danger that has been increased by nuclear proliferation and by the use of computers with very quick reaction times to control weapons systems.

Recent nuclear power plant accidents remind us that accidents frequently happen through human and technical failure, even for systems which are considered to be very "safe." We must also remember the time scale of the problem. To assure the future of humanity, nuclear catastrophe must be avoided year after year and decade after decade. In the long run, the safety of civilization cannot be achieved except by the abolition of nuclear weapons, and ultimately the abolition of the institution of war.

In 1985, International Physicians for the Prevention of Nuclear War received the Nobel



Figure 12.41: **Sculpture depicting Saint George slaying the dragon. The dragon is created from fragments of Soviet SS-20 and United States Pershing nuclear missiles. UN Photo/Milton Grant**

Peace Prize. IPPNW had been founded in 1980 by six physicians, three from the Soviet Union and three from the United States. Today, the organization has wide membership among the world's physicians. Professor Bernard Lowen of the Harvard School of Public Health, one of the founders of IPPNW, said in a recent speech:

“...No public health hazard ever faced by humankind equals the threat of nuclear war. Never before has man possessed the destructive resources to make this planet uninhabitable... Modern medicine has nothing to offer, not even a token benefit, in the event of nuclear war...”

“We are but transient passengers on this planet Earth. It does not belong to us. We are not free to doom generations yet unborn. We are not at liberty to erase humanity's past or dim its future. Social systems do not endure for eternity. Only life can lay claim to uninterrupted continuity. This continuity is sacred.”

The danger of a catastrophic nuclear war casts a dark shadow over the future of our species. It also casts a very black shadow over the future of the global environment. The environmental consequences of a massive exchange of nuclear weapons have been treated in a number of studies by meteorologists and other experts from both East and West. They predict that a large-scale use of nuclear weapons would result in fire storms with very high winds and high temperatures, which would burn a large proportion of the wild land fuels in the affected nations. The resulting smoke and dust would block out sunlight for a period of many months, at first only in the northern hemisphere but later also in the southern hemisphere.

Temperatures in many places would fall far below freezing, and much of the earth's plant life would be killed. Animals and humans would then die of starvation. The nuclear winter effect was first discovered as a result of the Mariner 9 spacecraft exploration of Mars in 1971. The spacecraft arrived in the middle of an enormous dust-storm on Mars, and measured a large temperature drop at the surface of the planet, accompanied by a heating of the upper atmosphere. These measurements allowed scientists to check their

theoretical models for predicting the effect of dust and other pollutants distributed in planetary atmospheres.

Using experience gained from the studies of Mars, R.P. Turco, O.B. Toon, T. Ackerman, J.B. Pollack and C. Sagan made a computer study of the climatic effects of the smoke and dust that would result from a large-scale nuclear war. This early research project is sometimes called the TTAPS Study, after the initials of the authors.

In April 1983, a special meeting was held in Cambridge, Massachusetts, where the results of the TTAPS Study and other independent studies of the nuclear winter effect were discussed by more than 100 experts. Their conclusions were presented at a forum in Washington, D.C., the following December, under the chairmanship of U.S. Senators Kennedy and Hatfield. The numerous independent studies of the nuclear winter effect all agreed of the following main predictions:

High-yield nuclear weapons exploded near the earth's surface would put large amounts of dust into the upper atmosphere. Nuclear weapons exploded over cities, forests, oilfields and refineries would produce fire storms of the type experienced in Dresden and Hamburg after incendiary bombings during the Second World War. The combination of high-altitude dust and lower altitude soot would prevent sunlight from reaching the earth's surface, and the degree of obscuration would be extremely high for a wide range of scenarios.

A baseline scenario used by the TTAPS study assumes a 5,000-megaton nuclear exchange, but the threshold for triggering the nuclear winter effect is believed to be much lower than that. After such an exchange, the screening effect of pollutants in the atmosphere might be so great that, in the northern and middle latitudes, the sunlight reaching the earth would be only 1% of ordinary sunlight on a clear day, and this effect would persist for many months. As a result, the upper layers in the atmosphere might rise in temperature by as much as 100 °C, while the surface temperatures would fall, perhaps by as much a 50 °C.

The temperature inversion produced in this way would lead to superstability, a condition in which the normal mixing of atmospheric layers is suppressed. The hydrological cycle (which normally takes moist air from the oceans to a higher and cooler level, where the moisture condenses as rain) would be strongly suppressed. Severe droughts would thus take place over continental land masses. The normal cleansing action of rain would be absent in the atmosphere, an effect which would prolong the nuclear winter.

In the northern hemisphere, forests would die because of lack of sunlight, extreme cold, and drought. Although the temperature drop in the southern hemisphere would be less severe, it might still be sufficient to kill a large portion of the tropical forests, which normally help to renew the earth's oxygen.

The oxygen content of the atmosphere would then fall dangerously, while the concentration of carbon dioxide and oxides of nitrogen produced by firestorms would remain high. The oxides of nitrogen would ultimately diffuse to the upper atmosphere, where they would destroy the ozone layer.

Thus, even when the sunlight returned after an absence of many months, it would be sunlight containing a large proportion of the ultraviolet frequencies which are normally absorbed by the ozone in the stratosphere, and therefore a type of light dangerous to life.

Finally, after being so severely disturbed, there is no guarantee that the global climate would return to its normal equilibrium.

Even a nuclear war below the threshold of nuclear winter might have climatic effects very damaging to human life. Professor Paul Ehrlich, of Stanford University, has expressed this in the following words:

“...A smaller war, which set off fewer fires and put less dust into the atmosphere, could easily depress temperatures enough to essentially cancel grain production in the northern hemisphere. That in itself would be the greatest catastrophe ever delivered upon Homo Sapiens, just that one thing, not worrying about prompt effects. Thus even below the threshold, one cannot think of survival of a nuclear war as just being able to stand up after the bomb has gone off.”¹⁸

12.19 Flaws in the concept of nuclear deterrence

Before discussing other defects in the concept of deterrence, it must be said very clearly that the idea of “massive nuclear retaliation” is completely unacceptable from an ethical point of view. The doctrine of retaliation, performed on a massive scale, violates not only

¹⁸<http://www.voanews.com/content/pope-francis-calls-for-nuclear-weapons-ban/2909357.html>
<http://www.cadmusjournal.org/article/issue-4/flaws-concept-nuclear-deterrence>
<http://www.countercurrents.org/avery300713.htm>
<https://www.wagingpeace.org/author/john-avery/>
<http://www.commondreams.org/news/2015/08/06/70-years-after-bombing-hiroshima-calls-abolish-nuclear-weapons>
<http://www.informationclearinghouse.info/article42488.htm>
<http://www.informationclearinghouse.info/article42492.htm>
<http://www.commondreams.org/views/2015/08/06/hiroshima-and-nagasaki-remembering-power>
<http://human-wrongs-watch.net/2015/07/22/israel-iran-and-the-nuclear-non-proliferation-treaty/>
<http://human-wrongs-watch.net/2015/06/25/militarisms-hostages/>
<http://human-wrongs-watch.net/2015/05/24/the-path-to-zero-dialogues-on-nuclear-dangers-by-richard-falk-and-david-krieger/>
<http://human-wrongs-watch.net/2015/03/30/europe-must-not-be-forced-into-a-nuclear-war-with-russia/>
<http://www.truth-out.org/opinion/item/32073-the-us-should-eliminate-its-nuclear-arsenal-not-modernize-it>
<http://www.cadmusjournal.org/article/issue-4/flaws-concept-nuclear-deterrence>
<http://www.cadmusjournal.org/article/issue-6/arms-trade-treaty-opens-new-possibilities-u>
<http://eruditio.worldacademy.org/issue-6/article/remember-your-humanity>
<http://www.informationclearinghouse.info/article42568.htm>
<https://firstlook.org/theintercept/2014/09/23/nobel-peace-prize-fact-day-syria-7th-country-bombed-obama/>
<http://www.informationclearinghouse.info/article42577.htm>
<http://www.informationclearinghouse.info/article42580.htm>
<http://human-wrongs-watch.net/2015/08/06/us-unleashing-of-atomic-weapons-against-civilian-populations-was-a-criminal-act-of-the-first-order/>
<http://human-wrongs-watch.net/2015/08/06/hiroshima-and-nagasaki-remembering-the-power-of-peace/>
<http://human-wrongs-watch.net/2015/08/04/atomic-bombing-hear-the-story-setsuko-thurlow/>
<http://human-wrongs-watch.net/2015/08/04/atomic-bombing-hear-the-story-yasuaki-yamashita/>
<http://human-wrongs-watch.net/2015/08/03/why-nuclear-weapons/>

the principles of common human decency and common sense, but also the ethical principles of every major religion. Retaliation is especially contrary to the central commandment of Christianity which tells us to love our neighbor, even if he or she is far away from us, belonging to a different ethnic or political group, and even if our distant neighbor has seriously injured us. This principle has a fundamental place not only in Christianity but also in Buddhism. "Massive retaliation" completely violates these very central ethical principles, which are not only clearly stated and fundamental but also very practical, since they prevent escalatory cycles of revenge and counter-revenge.

Contrast Christian ethics with estimates of the number of deaths that would follow a US nuclear strike against Russia: Several hundred million deaths. These horrifying estimates shock us not only because of the enormous magnitude of the expected mortality, but also because the victims would include people of every kind: women, men, old people, children and infants, completely irrespective of any degree of guilt that they might have. As a result of such an attack, many millions of people in neutral countries would also die. This type of killing has to be classified as genocide.

When a suspected criminal is tried for a wrongdoing, great efforts are devoted to clarifying the question of guilt or innocence. Punishment only follows if guilt can be proved beyond any reasonable doubt. Contrast this with the totally indiscriminate mass slaughter that results from a nuclear attack!

It might be objected that disregard for the guilt or innocence of victims is a universal characteristic of modern war, since statistics show that, with time, a larger and larger percentage of the victims have been civilians, and especially children. For example, the air attacks on Coventry during World War II, or the fire bombings of Dresden and Tokyo, produced massive casualties which involved all segments of the population with complete disregard for the question of guilt or innocence. The answer, I think, is that modern war has become generally unacceptable from an ethical point of view, and this unacceptability is epitomized in nuclear weapons.

The enormous and indiscriminate destruction produced by nuclear weapons formed the background for an historic 1996 decision by the International Court of Justice in the Hague. In response to questions put to it by WHO and the UN General Assembly, the Court ruled that "the threat and use of nuclear weapons would generally be contrary to the rules of international law applicable in armed conflict, and particularly the principles and rules of humanitarian law." The only *possible* exception to this general rule might be "an extreme circumstance of self-defense, in which the very survival of a state would be at stake". But the Court refused to say that even in this extreme circumstance the threat or use of nuclear weapons would be legal. It left the exceptional case undecided. In addition, the World Court added unanimously that "there exists an obligation to pursue in good faith *and bring to a conclusion* negotiations leading to nuclear disarmament in all its aspects under strict international control."

This landmark decision has been criticized by the nuclear weapon states as being decided "by a narrow margin", but the structuring of the vote made the margin seem more narrow than it actually was. Seven judges voted against Paragraph 2E of the decision (the paragraph which states that the threat or use of nuclear weapons would be generally

illegal, but which mentions as a possible exception the case where a nation might be defending itself from an attack that threatened its very existence.) Seven judges voted for the paragraph, with the President of the Court, Muhammad Bedjaoui of Algeria casting the deciding vote. Thus the Court adopted it, seemingly by a narrow margin. But three of the judges who voted against 2E did so because they believed that no possible exception should be mentioned! Thus, if the vote had been slightly differently structured, the result would have been ten to four.

Of the remaining four judges who cast dissenting votes, three represented nuclear weapons states, while the fourth thought that the Court ought not to have accepted the questions from WHO and the UN. However Judge Schwebel from the United States, who voted against Paragraph 2E, nevertheless added, in a separate opinion, "It cannot be accepted that the use of nuclear weapons on a scale which would - or could - result in the deaths of many millions in indiscriminate inferno and by far-reaching fallout, have pernicious effects in space and time, and render uninhabitable much of the earth, could be lawful." Judge Higgins from the UK, the first woman judge in the history of the Court, had problems with the word "generally" in Paragraph 2E and therefore voted against it, but she thought that a more profound analysis might have led the Court to conclude in favor of illegality in all circumstances. Judge Fleischhauer of Germany said in his separate opinion, "The nuclear weapon is, in many ways, the negation of the humanitarian considerations underlying the law applicable in armed conflict and the principle of neutrality. The nuclear weapon cannot distinguish between civilian and military targets. It causes immeasurable suffering. The radiation released by it is unable to respect the territorial integrity of neutral States."

President Bedjaoui, summarizing the majority opinion, called nuclear weapons "the ultimate evil", and said "By its nature, the nuclear weapon, this blind weapon, destabilizes humanitarian law, the law of discrimination in the use of weapons... The ultimate aim of every action in the field of nuclear arms will always be nuclear disarmament, an aim which is no longer utopian and which all have a duty to pursue more actively than ever."

Thus the concept of nuclear deterrence is not only unacceptable from the standpoint of ethics; it is also contrary to international law. The World Courts 1996 advisory Opinion unquestionably also represents the opinion of the majority of the world's peoples. Although no formal plebiscite has been taken, the votes in numerous resolutions of the UN General Assembly speak very clearly on this question. For example the New Agenda Resolution (53/77Y) was adopted by the General Assembly on 4 December 1998 by a massively affirmative vote, in which only 18 out of the 170 member states voted against the resolution.¹⁹ The New Agenda Resolution proposes numerous practical steps towards complete nuclear disarmament, and it calls on the Nuclear-Weapon States "to demonstrate an unequivocal commitment to the speedy and total elimination of their nuclear weapons and without delay to pursue in good faith and bring to a conclusion negotiations leading to the elimi-

¹⁹Of the 18 countries that voted against the New Agenda resolution, 10 were Eastern European countries hoping for acceptance into NATO, whose votes seem to have been traded for increased probability of acceptance.

nation of these weapons, thereby fulfilling their obligations under Article VI of the Treaty on the Non-Proliferation of Nuclear Weapons (NPT)". Thus, in addition to being ethically unacceptable and contrary to international law, nuclear weapons also contrary to the principles of democracy.

More recently, on 7 July, 2017, the Treaty on the Prohibition of Nuclear Weapons was passed by a massive majority in the General Assembly of the United Nations, It was opposed only by the nuclear weapons states and a few of their allies. The Nuclear Ban Treaty makes it very clear that nuclear weapons are illegal under international law. Although the nuclear weapons states still cling to their world-destroying weapons, it is to be hoped that the force of global public opinion will eventually force them to comply with the law.

Having said these important things, we can now turn to some of the other defects in the concept of nuclear deterrence. One important defect is that nuclear war may occur through accident or miscalculation - through technical defects or human failings. This possibility is made greater by the fact that despite the end of the Cold War, thousands of missiles carrying nuclear warheads are still kept on a "hair-trigger" state of alert with a quasi-automatic reaction time measured in minutes. There is a constant danger that a nuclear war will be triggered by error in evaluating the signal on a radar screen. For example, the BBC reported recently that a group of scientists and military leaders are worried that a small asteroid entering the earths atmosphere and exploding could trigger a nuclear war if mistaken for a missile strike.

A number of prominent political and military figures (many of whom have ample knowledge of the system of deterrence, having been part of it) have expressed concern about the danger of accidental nuclear war. Colin S. Grey²⁰ expressed this concern as follows: "The problem, indeed the enduring problem, is that we are resting our future upon a nuclear deterrence system concerning which we cannot tolerate even a single malfunction." General Curtis E. LeMay²¹ has written, "In my opinion a general war will grow through a series of political miscalculations and accidents rather than through any deliberate attack by either side." Bruce G. Blair²² has remarked that "It is obvious that the rushed nature of the process, from warning to decision to action, risks causing a catastrophic mistake."... "This system is an accident waiting to happen."

Today, the system that is supposed to give us security is called Mutually Assured Destruction, appropriately abbreviated as MAD. It is based on the idea of deterrence, which maintains that because of the threat of massive retaliation, no sane leader would start a nuclear war.

One important defect in the concept of deterrence is the fact that nuclear war may occur through accident or miscalculation, through technical defects or human failings, or by terrorism. This possibility is made greater by the fact that despite the end of the Cold War, thousands of missiles carrying nuclear warheads are still kept on "hair-trigger alert"

²⁰Chairman, National Institute for Public Policy

²¹Founder and former Commander in Chief of the United States Strategic Air Command

²²Brookings Institute

with a quasi-automatic reaction time measured in minutes. There is a constant danger that a nuclear war will be triggered by error in evaluating the signal on a radar screen.

Incidents in which global disaster is avoided by a hair's breadth are constantly occurring. For example, on the night of 26 September, 1983, Lt. Col. Stanislav Petrov, a young software engineer, was on duty at a surveillance center near Moscow. Suddenly the screen in front of him turned bright red.

An alarm went off. It's enormous piercing sound filled the room. A second alarm followed, and then a third, fourth and fifth. "The computer showed that the Americans had launched a strike against us", Petrov remembered later. His orders were to pass the information up the chain of command to Secretary General Yuri Andropov. Within minutes, a nuclear counterattack would be launched. However, because of certain inconsistent features of the alarm, Petrov disobeyed orders and reported it as a computer error, which indeed it was.

Most of us probably owe our lives to his coolheaded decision and knowledge of software systems. The narrowness of this escape is compounded by the fact that Petrov was on duty only because of the illness of another officer with less knowledge of software, who would have accepted the alarm as real.

Narrow escapes such as this show us clearly that in the long run, the combination of space-age science and stone-age politics will destroy us. We urgently need new political structures and new ethics to match our advanced technology.

12.20 Dangers of nuclear power generation

The Chernobyl disaster

The dangers of nuclear power generation are exemplified by the Chernobyl disaster: On the 26th of April, 1986, during the small hours of the morning, the staff of the Chernobyl nuclear reactor in Ukraine turned off several safety systems in order to perform a test. The result was a core meltdown in Reactor 4, causing a chemical explosion that blew off the reactor's 1,000-ton steel and concrete lid. 190 tons of highly radioactive uranium and graphite were hurled into the atmosphere. The resulting radioactive fallout was 200 times greater than that caused by the nuclear bombs that destroyed Hiroshima and Nagasaki. The radioactive cloud spread over Belarus, Ukraine, Russia, Finland, Sweden and Eastern Europe, exposing the populations of these regions to levels of radiation 100 times the normal background. Ultimately, the radioactive cloud reached as far as Greenland and parts of Asia.

The exact number of casualties resulting from the Chernobyl meltdown is a matter of controversy, but according to a United Nations report, as many as 9 million people have been adversely affected by the disaster. Since 1986, the rate of thyroid cancer in affected areas has increased ten-fold. An area of 155,000 square kilometers (almost half the size of Italy) in Belarus, Ukraine and Russia is still severely contaminated. Even as far away as Wales, hundreds of farms are still under restrictions because of sheep eating radioactive

grass.

Public opinion turned against nuclear power generation as a result of the Chernobyl disaster. Had the disaster taken place in Western Europe or North America, its effect on public opinion would have been still greater. Nevertheless, because of the current energy crisis, and because of worries about global warming, a number of people are arguing that nuclear energy should be given a second chance. The counter-argument is that a large increase in the share of nuclear power in the total spectrum of energy production would have little effect on climate change but it would involve unacceptable dangers, not only dangers of accidents and dangers associated with radioactive waste disposal, but above all, dangers of proliferation of nuclear weapons.

Of the two bombs that destroyed Hiroshima and Nagasaki, one made use of the rare isotope of uranium, U-235, while the other used plutonium. Both of these materials can be made by a nation with a nuclear power generation program.

Reactors and nuclear weapons

Uranium has atomic number 92, i.e., a neutral uranium atom has a nucleus containing 92 positively-charged protons, around which 92 negatively-charged electrons circle. All of the isotopes of uranium have the same number of protons and electrons, and hence the same chemical properties, but they differ in the number of neutrons in their nuclei. For example, the nucleus of U-235 has 143 neutrons, while that of U-238 has 146. Notice that $92+143=235$, while $92+146=238$. The number written after the name of an element to specify a particular isotope is the number of neutrons plus the number of protons. This is called the "nucleon number", and the weight of an isotope is roughly proportional to it. This means that U-238 is slightly heavier than U-235. If the two isotopes are to be separated, difficult physical methods dependent on mass must be used, since their chemical properties are identical. In natural uranium, the amount of the rare isotope U-235 is only 0.7 percent.

A paper published in 1939 by Niels Bohr and John A. Wheeler indicated that it was the rare isotope of uranium, U-235, that undergoes fission. A bomb could be constructed, they pointed out, if enough highly enriched U-235 could be isolated from the more common isotope, U-238. Calculations later performed in England by Otto Frisch and Rudolf Peierls showed that the "critical mass" of highly enriched uranium needed is quite small: only a few kilograms.

The Bohr-Wheeler theory also predicted that an isotope of plutonium, Pu-239, should be just as fissionable as U-235²³. Instead of trying to separate the rare isotope, U-235, from the common isotope, U-238, physicists could just operate a nuclear reactor until a

²³Both U-235 and Pu-239 have odd nucleon numbers. When U-235 absorbs a neutron, it becomes U-236, while when Pu-239 absorbs a neutron it becomes Pu-240. In other words, absorption of a neutron converts both these species to nuclei with even nucleon numbers. According to the Bohr-Wheeler theory, nuclei with even nucleon numbers are especially tightly-bound. Thus absorption of a neutron converts U-235 to a highly-excited state of U-236, while Pu-239 is similarly converted to a highly excited state of Pu-240. The excitation energy distorts the nuclei to such an extent that fission becomes possible.

sufficient amount of Pu-239 accumulated, and then separate it out by ordinary chemical means.

Thus in 1942, when Enrico Fermi and his coworkers at the University of Chicago produced the world's first controlled chain reaction within a pile of cans containing ordinary (nonenriched) uranium powder, separated by blocks of very pure graphite, the chain-reacting pile had a double significance: It represented a new source of energy for mankind, but it also had a sinister meaning. It represented an easy path to nuclear weapons, since one of the by-products of the reaction was a fissionable isotope of plutonium, Pu-239. The bomb dropped on Hiroshima in 1945 used U-235, while the Nagasaki bomb used Pu-239.

By reprocessing spent nuclear fuel rods, using ordinary chemical means, a nation with a power reactor can obtain weapons-usable Pu-239. Even when such reprocessing is performed under international control, the uncertainty as to the amount of Pu-239 obtained is large enough so that the operation might superficially seem to conform to regulations while still supplying enough Pu-239 to make many bombs.

The enrichment of uranium²⁴ is also linked to reactor use. Many reactors of modern design make use of low enriched uranium (LEU) as a fuel. Nations operating such a reactor may claim that they need a program for uranium enrichment in order to produce LEU for fuel rods. However, by operating their ultracentrifuges a little longer, they can easily produce highly enriched uranium (HEU), i.e., uranium containing a high percentage of the rare isotope U-235, and therefore usable in weapons.

Known reserves of uranium are only sufficient for the generation of 8×10^{20} joules of electrical energy²⁵, i.e., about 25 TWy. It is sometimes argued that a larger amount of electricity could be obtained from the same amount of uranium through the use of fast breeder reactors, but this would involve totally unacceptable proliferation risks. In fast breeder reactors, the fuel rods consist of highly enriched uranium. Around the core, is an envelope of natural uranium. The flux of fast neutrons from the core is sufficient to convert a part of the U-238 in the envelope into Pu-239, a fissionable isotope of plutonium.

Fast breeder reactors are prohibitively dangerous from the standpoint of nuclear proliferation because both the highly enriched uranium from the fuel rods and the Pu-239 from the envelope are directly weapons-usable. It would be impossible, from the standpoint of equity, to maintain that some nations have the right to use fast breeder reactors, while others do not. If all nations used fast breeder reactors, the number of nuclear weapons states would increase drastically.

It is interesting to review the way in which Israel, South Africa, Pakistan, India and North Korea²⁶ obtained their nuclear weapons, since in all these cases the weapons were constructed under the guise of "atoms for peace", a phrase that future generations may someday regard as being tragically self-contradictory.

Israel began producing nuclear weapons in the late 1960's (with the help of a "peaceful"

²⁴i.e. production of uranium with a higher percentage of U-235 than is found in natural uranium

²⁵Craig, J.R., Vaugn, D.J. and Skinner, B.J., *Resources of the Earth: Origin, Use and Environmental Impact, Third Edition*, page 210.

²⁶Israel, India and Pakistan have refused to sign the Nuclear Non-Proliferation Treaty, and North Korea, after signing the NPT, withdrew from it in 2003.

nuclear reactor provided by France, and with the tacit approval of the United States) and the country is now believed to possess 100-150 of them, including neutron bombs. Israel's policy is one of visibly possessing nuclear weapons while denying their existence.

South Africa, with the help of Israel and France, also weaponized its civil nuclear program, and it tested nuclear weapons in the Indian Ocean in 1979. In 1991 however, South Africa destroyed its nuclear weapons and signed the NPT.

India produced what it described as a "peaceful nuclear explosion" in 1974. By 1989 Indian scientists were making efforts to purify the lithium-6 isotope, a key component of the much more powerful thermonuclear bombs. In 1998, India conducted underground tests of nuclear weapons, and is now believed to have roughly 60 warheads, constructed from Pu-239 produced in "peaceful" reactors.

Pakistan's efforts to obtain nuclear weapons were spurred by India's 1974 "peaceful nuclear explosion". As early as 1970, the laboratory of Dr. Abdul Qadeer Khan, (a metallurgist who was to become Pakistan's leading nuclear bomb maker) had been able to obtain from a Dutch firm the high-speed ultracentrifuges needed for uranium enrichment. With unlimited financial support and freedom from auditing requirements, Dr. Khan purchased restricted items needed for nuclear weapon construction from companies in Europe and the United States. In the process, Dr. Khan became an extremely wealthy man. With additional help from China, Pakistan was ready to test five nuclear weapons in 1998. The Indian and Pakistani nuclear bomb tests, conducted in rapid succession, presented the world with the danger that these devastating weapons would be used in the conflict over Kashmir. Indeed, Pakistan announced that if a war broke out using conventional weapons, Pakistan's nuclear weapons would be used "at an early stage".

In Pakistan, Dr. A.Q. Khan became a great national hero. He was presented as the person who had saved Pakistan from attack by India by creating Pakistan's own nuclear weapons. In a Washington Post article²⁷ Pervez Hoodbhoy wrote: "Nuclear nationalism was the order of the day as governments vigorously promoted the bomb as the symbol of Pakistan's high scientific achievement and self-respect..." Similar manifestations of nuclear nationalism could also be seen in India after India's 1998 bomb tests.

Early in 2004, it was revealed that Dr. Khan had for years been selling nuclear secrets and equipment to Libya, Iran and North Korea, and that he had contacts with Al-Qaeda. However, observers considered that it was unlikely that Khan would be tried, since a trial might implicate Pakistan's army as well as two of its former prime ministers.

Recent assassination attempts directed at Pakistan's President, Pervez Musharraf, emphasize the precariousness of Pakistan's government. There a danger that it may be overthrown, and that the revolutionists would give Pakistan's nuclear weapons to a subnational organization. This type of danger is a general one associated with nuclear proliferation. As more and more countries obtain nuclear weapons, it becomes increasingly likely that one of them will undergo a revolution, during the course of which nuclear weapons will fall into the hands of criminals or terrorists.

If nuclear reactors become the standard means for electricity generation as the result of

²⁷1 February, 2004

a future energy crisis, the number of nations possessing nuclear weapons might ultimately be as high as 40. If this should happen, then over a long period of time the chance that one or another of these nations would undergo a revolution during which the weapons would fall into the hands of a subnational group would gradually grow into a certainty.

There is also a possibility that poorly-guarded fissionable material could fall into the hands of subnational groups, who would then succeed in constructing their own nuclear weapons. Given a critical mass of highly-enriched uranium, a terrorist group, or an organized criminal (Mafia) group, could easily construct a crude gun-type nuclear explosive device. Pu-239 is more difficult to use since it is highly radioactive, but the physicist Frank Barnaby believes that a subnational group could nevertheless construct a crude nuclear bomb (of the Nagasaki type) from this material.

We must remember the remark of U.N. Secretary General Kofi Annan after the 9/11/2001 attacks on the World Trade Center. He said, "*This time* it was not a nuclear explosion". The meaning of his remark is clear: If the world does not take strong steps to eliminate fissionable materials and nuclear weapons, it will only be a matter of time before they will be used in terrorist attacks on major cities, or by organized criminals for the purpose of extortion. Neither terrorists nor organized criminals can be deterred by the threat of nuclear retaliation, since they have no territory against which such retaliation could be directed. They blend invisibly into the general population. Nor can a "missile defense system" prevent criminals or terrorists from using nuclear weapons, since the weapons can be brought into a port in any one of the hundreds of thousands of containers that enter on ships each year, a number far too large to be checked exhaustively.

Finally we must remember that if the number of nations possessing nuclear weapons becomes very large, there will be a greatly increased chance that these weapons will be used in conflicts between nations, either by accident or through irresponsible political decisions.

On November 3, 2003, Mohamed ElBaradei, Director General of the International Atomic Energy Agency, made a speech to the United Nations in which he called for "limiting the processing of weapons-usable material (separated plutonium and high enriched uranium) in civilian nuclear programs - as well as the production of new material through reprocessing and enrichment - by agreeing to restrict these operations to facilities exclusively under international control." It is almost incredible, considering the dangers of nuclear proliferation and nuclear terrorism, that such restrictions were not imposed long ago.

From the facts that we have been reviewing, we can conclude that if nuclear power generation becomes widespread during a future energy crisis, and if equally widespread proliferation of nuclear weapons is to be avoided, the powers and budget of the IAEA will have to be greatly increased. All enrichment of uranium and Reprocessing fuel rods throughout the world will have to be placed be under direct international control, as has been emphasized by Mohamed ElBaradei. Because this will need to be done with fairness, such regulations will have to hold both in countries that at present have nuclear weapons and in countries that do not. It has been proposed that there should be an international fuel rod bank, to supply new fuel rods and reprocess spent ones. In addition to this excellent proposal, one might also consider a system where all power generation reactors

and all research reactors would be staffed by the IAEA.

Nuclear reactors used for “peaceful” purposes unfortunately also generate fissionable isotopes of not only of plutonium, but also of neptunium and americium. Thus all nuclear reactors must be regarded as ambiguous in function, and all must be put under strict international control. One must ask whether globally widespread use of nuclear energy is worth the danger that it entails.

Let us now examine the question of whether nuclear power generation would appreciably help to prevent global warming. The fraction of nuclear power in the present energy generation spectrum is at present approximately 1/16. Nuclear energy is used primarily for electricity generation. Thus increasing the nuclear fraction would not affect the consumption of fossil fuels used directly in industry, transportation, in commerce, and in the residential sector. Coal is still a very inexpensive fuel, and an increase in nuclear power generation would do little to prevent it from being burned. Thus besides being prohibitively dangerous, and besides being unsustainable in the long run (because of finite stocks of uranium and thorium), the large-scale use of nuclear power cannot be considered to be a solution to the problem of anthropogenic climate change.

Optimists point to the possibility of using fusion of light elements, such as hydrogen, to generate power. However, although this can be done on a very small scale (and at great expense) in laboratory experiments, the practical generation of energy by means of thermonuclear reactions remains a mirage rather than a realistic prospect on which planners can rely. The reason for this is the enormous temperature required to produce thermonuclear reactions. This temperature is comparable to that existing in the interior of the sun, and it is sufficient to melt any ordinary container. Elaborate “magnetic bottles” have been constructed to contain thermonuclear reactions, and these have been used in successful very small scale experiments. However, despite 50 years of heavily-financed research, there has been absolutely no success in producing thermonuclear energy on a large scale, or at anything remotely approaching commercially competitive prices.

Nuclear weapons are criminal! Every war is a crime!

War was always madness, always immoral, always the cause of unspeakable suffering, economic waste and widespread destruction, and always a source of poverty, hate, barbarism and endless cycles of revenge and counter-revenge. It has always been a crime for soldiers to kill people, just as it is a crime for murderers in civil society to kill people. No flag has ever been wide enough to cover up atrocities.

But today, the development of all-destroying modern weapons has put war completely beyond the bounds of sanity and elementary humanity.

Can we not rid ourselves of both nuclear weapons and the institution of war itself? We must act quickly and resolutely before everything that we love in our beautiful world is reduced to radioactive ashes.

12.21 Militarism is the US national religion

Here are some quotations from an article by William Astore entitled *Military Might Is Our National Religion*²⁸. He lists the following facts to support his thesis:

- We believe in wars. We may no longer believe in formal declarations of war (not since December 1941 has Congress made one in our name), but that sure hasn't stopped us from waging them. From Korea to Vietnam, Afghanistan to Iraq, the Cold War to the War on Terror, and so many military interventions in between, including Grenada, Panama, and Somalia, Americans are always fighting somewhere as if we saw great utility in thumbing our noses at the Prince of Peace. (That's Jesus Christ, if I remember my Catholic catechism correctly.)
- We believe in weaponry, the more expensive the better. The underperforming F-35 stealth fighter may cost \$1.45 trillion over its lifetime. An updated nuclear triad (land-based missiles, nuclear submarines, and strategic bombers) may cost that already mentioned \$1.7 trillion. New (and malfunctioning) aircraft carriers cost us more than \$10 billion each. And all such weaponry requests get funded, with few questions asked, despite a history of their redundancy, ridiculously high price, regular cost overruns, and mediocre performance. Meanwhile, Americans squabble bitterly over a few hundred million dollars for the arts and humanities.
- We believe in weapons of mass destruction. We believe in them so strongly that we're jealous of anyone nibbling at our near monopoly. As a result, we work overtime to ensure that "infidels" and atheists (that is, the Iranians and North Koreans, among others) don't get them. In historical terms, no country has devoted more research or money to deadly nuclear, biological, and chemical weaponry than the United States. In that sense, we've truly put our money where our mouths are (and where a devastating future might be).
- We believe with missionary zeal in our military and seek to establish our "faith" everywhere. Hence, our global network of perhaps 800 overseas military bases. We don't hesitate to deploy our elite missionaries, our equivalent to the Jesuits, the Special Operations forces to more than 130 countries annually. Similarly, the foundation for what we like to call foreign assistance is often military training and foreign military sales. Our present supreme leader, Pope Trump I, boasts of military sales across the globe, most notably to the "infidel" Saudis. Even when Congress makes what, until recently, was the rarest of attempts to rein in this deadly trade

²⁸Truthout, August 13, 2019

in arms, Pope Trump vetoes it. His rationale: weapons and profits should rule all.

- We believe in our college of cardinals, otherwise known as America's generals and admirals. We sometimes appoint them (or anoint them?) to the highest positions in the land. While Trump's generals - Michael Flynn, James Mattis, H.R. McMaster, and John Kelly - have fallen from grace at the White House, America's generals and admirals continue to rule globally. They inhabit proconsul-like positions in sweeping geographical commands that (at least theoretically) cover the planet and similarly lead commands aimed at dominating the digital-computer realm and special operations. One of them will head a new force meant to dominate space through time eternal. A "strategic" command (the successor to the Strategic Air Command, or SAC, so memorably satirized in Stanley Kubrick's *Dr. Strangelove*) continues to ensure that, at some future moment, the U.S. will be able to commit mass genocide by quite literally destroying the world with nuclear weapons. Indeed, Pope Trump recently boasted that he could end America's Afghan War in a week, apparently through the mass nuclear genocide of (his figure) 10 million Afghans. Even as he then blandly dismissed the idea of wiping that country "off the face of the earth," he openly reflected the more private megalomania of those military professionals funded by the rest of us to think about "the unthinkable". In sum, everything is - theoretically at least - under the thumbs of our unelected college of cardinals. Their overblown term for it is "full-spectrum dominance," which, in translation, means they grant themselves god-like powers over our lives and that of our planet (though the largely undefeated enemies in their various wars don't seem to have acknowledged this reality).
- We believe that freedom comes through obedience. Those who break ranks from our militarized church and protest, like Chelsea Manning, are treated as heretics and literally tortured.
- We believe military spending brings wealth and jobs galore, even when it measurably doesn't. Military production is both increasingly automated and increasingly outsourced, leading to far fewer good-paying American jobs compared to spending on education, infrastructure repairs of and improvements in roads, bridges, levees, and the like, or just about anything else for that matter.
- We believe, and our most senior leaders profess to believe, that our military represents the very best of us, that we have the "finest" one in human history.



Figure 12.42: The peoples of the world must revolt against the endless wars of their governments. All-destroying modern weapons have made the institution of war prohibitively dangerous.

- We believe in planning for a future marked by endless wars, whether against terrorism or “godless” states like China and Russia, which means our military church must be forever strengthened in the cause of winning ultimate victory.

Suggestions for further reading

1. P.J. Bowler, *Evolution: The History of an Idea*, University of California Press, (1989).
2. D.J. Futuyma, *Evolutionary Biology*, Sinauer Associates, Sunderland Mass., (1986).
3. B. Glass, O. Temkin, and W.L. Strauss, eds., *Forerunners of Darwin: 1745-1859*, Johns Hopkins Press, Baltimore, (1959).
4. R. Milner, *The Encyclopedia of Evolution*, an Owl Book, Henry Holt and Company, New York, (1990).
5. T.A. Appel, *The Cuvier-Geoffroy Debate: French Biology in the Decades before Darwin*, Oxford University Press, (1987).
6. P.J. Bowler, *Fossils and Progress: Paleontology and the Idea of Progressive Evolution in the Nineteenth Century*, Science History Publications, New York, (1976).
7. P. Corsi, *The Age of Lamarck: Evolutionary Theories in France, 1790-1834*, University of California Press, Berkeley, (1988).
8. M. McNeil, *Under the Banner of Science: Erasmus Darwin and his Age*, Manchester University Press, Manchester, (1987).
9. L.G. Wilson, *Sir Charles Lyell's Scientific Journals on the Species Question*, Yale University Press, New Haven, (1970).
10. A.B. Adams, *Eternal Quest: The Story of the Great Naturalists*, G.P. Putnam's Sons, New York, (1969).
11. A.S. Packard, *Lamarck, the Founder of Evolution: His Life and Work*, Longmans, Green, and Co., New York, (1901).
12. C. Darwin, *An historical sketch of the progress of opinion on the Origin of Species, previously to the publication of this work*, Appended to third and later editions of *On the Origin of Species*, (1861).
13. L. Eiseley, *Darwin's Century: Evolution and the Men who Discovered It*, Doubleday, New York, (1958).
14. H.F. Osborne, *From the Greeks to Darwin: The Development of the Evolution Idea Through Twenty-Four Centuries*, Charles Scribner and Sons, New York, (1929).
15. Sir Julian Huxley and H.B.D. Kettlewell, *Charles Darwin and his World*, Thames and Hudson, London (1965).
16. Allan Moorehead, *Darwin and the Beagle*, Penguin Books Ltd. (1971).
17. Francis Darwin (editor), *The Autobiography of Charles Darwin and Selected Letters*, Dover, New York (1958).
18. Charles Darwin, *The Voyage of the Beagle*, J.M. Dent and Sons Ltd., London (1975).
19. Charles Darwin, *The Origin of Species*, Collier MacMillan, London (1974).
20. Charles Darwin, *The Expression of Emotions in Man and Animals*, The University of Chicago Press (1965).
21. Ruth Moore, *Evolution*, Time-Life Books (1962).
22. L. Barber, *The Heyday of Natural History: 1820-1870*, Doubleday and Co., Garden City, New York, (1980).
23. A. Desmond, *Huxley*, Addison Wesley, Reading, Mass., (1994).
24. R. Owen, (P.R. Sloan editor), *The Hunterian Lectures in Comparative Anatomy, May-June, 1837*, University of Chicago Press, (1992).

25. C. Nichols, *Darwinism and the social sciences*, Phil. Soc. Scient. **4**, 255-277 (1974).
26. M. Ruse, *The Darwinian Revolution*, University of Chicago Press, (1979).
27. A. Desmond and J. Moore, *Darwin*, Penguin Books, (1992).
28. R. Dawkins, *The Extended Phenotype*, Oxford University Press, (1982).
29. R. Dawkins, *The Blind Watchmaker*, W.W. Norton, (1987).
30. R. Dawkins, *River out of Eden: A Darwinian View of Life*, Harper Collins, (1995).
31. R. Dawkins, *Climbing Mount Improbable*, W.W. Norton, (1996).
32. S.J. Gould, *Ever Since Darwin*, W.W. Norton, (1977).
33. R.G.B. Reid, *Evolutionary Theory: The Unfinished Synthesis*, Croom Helm, (1985).
34. M. Ho and P.T. Saunders, editors, *Beyond Neo-Darwinism: An Introduction to a New Evolutionary Paradigm*, Academic Press, London, (1984).
35. J. Maynard Smith, *Did Darwin Get it Right? Essays on Games, Sex and Evolution*, Chapman and Hall, (1989).
36. E. Sober, *The Nature of Selection: Evolutionary Theory in Philosophical Focus*, University of Chicago Press, (1984).
37. B.K. Hall, *Evolutionary Developmental Biology*, Chapman and Hall, London, (1992).
38. J. Thompson, *Interaction and Coevolution*, Wiley and Sons, (1982).
39. R.A. Fisher, *The Genetical Theory of Natural Selection*, Clarendon, Oxford, (1930).
40. J.B.S. Haldane, *Population genetics*, New Biology **18**, 34-51, (1955).
41. N. Tinbergen, *The Study of Instinct*, Oxford University Press, (1951).
42. N. Tinbergen, *The Herring Gull's World*, Collins, London, (1953).
43. N. Tinbergen, *Social Behavior in Animals*, Methuen, London, (1953).
44. N. Tinbergen, *Curious Naturalists*, Country Life, London, (1958).
45. N. Tinbergen, *The Animal in its World: Explorations of an Ethologist*, Allan and Unwin, London, (1973).
46. K. Lorenz, *On the evolution of behavior*, Scientific American, December, (1958).
47. K. Lorenz, *Evolution and Modification of Behavior* Harvard University Press, Cambridge, MA, (1961).
48. K. Lorenz, *Studies in Animal and Human Behavior. I and II.*, Harvard University Press, (1970) and (1971).
49. P.H. Klopfer and J.P. Hailman, *An Introduction to Animal Behavior: Ethology's First Century*, Prentice-Hall, New Jersey, (1969).
50. J. Jaynes, *The historical origins of "Ethology" and "Comparative Psychology"*, Anim. Behav. **17**, 601-606 (1969).
51. W.H. Thorpe, *The Origin and Rise of Ethology: The Science of the Natural Behavior of Animals*, Heinemann, London, (1979).
52. R.A. Hinde, *Animal Behavior: A Synthesis of Ethological and Comparative Psychology*, McGraw-Hill, New York, (1970).
53. J.H. Crook, editor, *Social Behavior in Birds and Mammals*, Academic Press, London, (1970).
54. P. Ekman, editor, *Darwin and Facial Expression*, Academic Press, New York, (1973).
55. P. Ekman, W.V. Friesen and P. Ekworth, *Emotions in the Human Face*, Pergamon, New York, (1972).

56. N. Blurton Jones, editor, *Ethological Studies of Child Behavior*, Cambridge University Press, (1975).
57. M. von Cranach, editor, *Methods of Inference from Animals to Human Behavior*, Chicago/Mouton, Haag, (1976); Aldine, Paris, (1976).
58. K. Lorenz, *On Aggression*, Bantem Books, (1977).
59. I. Eibl-Eibesfeldt, *Ethology, The Biology of Behavior*, Holt, Rinehart and Winston, New York, (1975).
60. I. Eibl-Eibesfeldt and F.K. Salter, editors, *Indoctrinability, Ideology, and Warfare: Evolutionary Perspectives*, Berghahn Books, (1998).
61. I. Eibl-Eibesfeldt, *Human Ethology*, Walter De Gruyter Inc., (1989).
62. I. Eibl-Eibesfeldt, *Love and Hate*, Walter De Gruyter Inc., (1996).
63. J. Bowlby, *By ethology out of psychoanalysis: An experiment in interbreeding*, *Animal Behavior*, **28**, 649-656 (1980).
64. B.B. Beck, *Animal Tool Behavior*, Garland STPM Press, New York, (1980).
65. R. Axelrod, *The Evolution of Cooperation*, Basic Books, New York, (1984).
66. J.D. Carthy and F.L. Ebling, *The Natural History of Aggression*, Academic Press, New York, (1964)
67. D.L. Cheney and R.M. Seyfarth, *How Monkeys See the World: Inside the Mind of Another Species*, University of Chicago Press, (1990).
68. F. De Waal, *Chimpanzee Politics*, Cape, London, (1982).
69. M. Edmunds, *Defense in Animals*, Longman, London, (1974).
70. R.D. Estes, *The Behavior Guide to African Mammals*, University of California Press, Los Angeles, (1991).
71. R.F. Ewer, *Ethology of Mammals*, Logos Press, London, (1968).
72. E. Morgan, *The Scars of Evolution*, Oxford University Press, (1990).
73. W.D. Hamilton, *The genetical theory of social behavior. I and II*, *J. Theor. Biol.* **7**, 1-52 (1964).
74. R. Dawkins, *The Selfish Gene*, Oxford University Press, (1989).
75. R.W. Sussman, *The Biological Basis of Human Behavior*, Prentice Hall, Englewood Cliffs, (1997).
76. Irenäus Eibl-Eibesfeldt, *The Biology of Peace and War*, Thames and Hudson, New York (1979).
77. R.A. Hinde, *Biological Bases of Human Social Behavior*, McGraw-Hill, New York (1977).
78. R.A. Hinde, *Towards Understanding Relationships*, Academic Press, London (1979).
79. Albert Szent-Györgyi, *The Crazy Ape*, Philosophical Library, New York (1970).
80. E.O. Wilson, *Sociobiology*, Harvard University Press (1975).
81. C. Zhan-Waxler, *Altruism and Aggression: Biological and Social Origins*, Cambridge University Press (1986).
82. D.R. Griffin, *Animal Mind - Human Mind*, Dahlem Konferenzen 1982, Springer, Berlin, (1982).
83. R. Dart, *The predatory transition from ape to man*, *International Anthropological and Linguistic Review*, **1**, (1953).

84. S. Savage-Rumbaugh, R. Lewin, et al., *Kanzi: The Ape at the Brink of the Human Mind*, John Wiley and Sons, New York, (1996).
85. R. Dunbar, *Grooming, Gossip, and the Evolution of Language*, Harvard University Press, (1998).
86. M.E. Bitterman, *The evolution of intelligence*, Scientific American, January, (1965).
87. R. Fox, *In the beginning: Aspects of hominid behavioral evolution*, Man, **NS 2**, 415-433 (1967).
88. M.S. Gazzaniga, *The split brain in man*, Scientific American, **217**, 24-29 (1967).
89. D. Kimura, *The asymmetry of the human brain*, Scientific American, **228**, 70-78 (1973).
90. R.G. Klein, *Anatomy, behavior, and modern human origins*, Journal of World Prehistory, **9 (2)**, 167-198 (1995).
91. N.G. Jablonski and L.C. Aiello, editors, *The Origin and Diversification of Language*, Wattis Symposium Series in Anthropology. Memoirs of the California Academy of Sciences, No. 24, The California Academy of Sciences, San Francisco, (1998).
92. S. Pinker, *The Language Instinct: How the Mind Creates Language*, Harper-Collins Publishers, New York, (1995).
93. J.H. Barkow, L. Cosmides and J. Tooby, editors, *The Adapted Mind: Evolutionary Psychology and the Generation of Culture*, Oxford University Press, (1995).
94. D.R. Begun, C.V. Ward and M.D. Rose, *Function, Phylogeny and Fossils: Miocene Hominid Evolution and Adaptations*, Plenum Press, New York, (1997).
95. R.W. Byrne and A.W. Whitten, *Machiavellian Intelligence: Social Expertise and the Evolution of Intellect in Monkeys, Apes and Humans*, Cambridge University Press, (1988),
96. V.P. Clark, P.A. Escholz and A.F. Rosa, editors, *Language: Readings in Language and Culture*, St Martin's Press, New York, (1997).
97. T.W. Deacon, *The Symbolic Species: The Co-evolution of Language and the Brain*, W.W. Norton and Company, New York, (1997).
98. C. Gamble, *Timewalkers: The Prehistory of Global Colonization*, Harvard University Press, (1994).
99. K.R. Gibson and T. Ingold, editors, *Tools, Language and Cognition in Human Evolution*, Cambridge University Press, (1993).
100. P. Mellers, *The Emergence of Modern Humans: An Archaeological Perspective*, Edinburgh University Press, (1990).
101. P. Mellers, *The Neanderthal Legacy: An Archaeological Perspective of Western Europe*, Princeton University Press, (1996).
102. S. Mithen, *The Prehistory of the Mind*, Thames and Hudson, London, (1996).
103. D. Haraway, *Signs of dominance: from a physiology to a cybernetics of primate biology*, C.R. Carpenter, 1939-1970, Studies in History of Biology, **6**, 129-219 (1983).
104. D. Johanson and M. Edey, *Lucy: The Beginnings of Humankind*, Simon and Schuster, New York, (1981).
105. B. Kurtén, *Our Earliest Ancestors*, Columbia University Press, New York, (1992).
106. R.E. Leakey and R. Lewin, *Origins Reconsidered*, Doubleday, New York, (1992).

107. P. Lieberman, *The Biology and Evolution of Language*, Harvard University Press, (1984).
108. J.D. Wall and M. Przeworski, *When did the human population size start increasing?*, *Genetics*, **155**, 1865-1874 (2000).
109. L. Aiello and C. Dean, *An Introduction to Human Evolutionary Anatomy*, Academic Press, London, (1990).
110. F. Ikawa-Smith, ed., *Early Paleolithic in South and East Asia*, Mouton, The Hague, (1978).
111. R.R. Baker, *Migration: Paths Through Space and Time*, Hodder and Stoughton, London, (1982).
112. P. Bellwood, *Prehistory of the Indo-Malaysian Archipelago*, Academic Press, Sidney, (1985).
113. P.J. Bowler, *Theories of Human Evolution: A Century of Debate, 1884-1944*, Basil Blackwell, Oxford, (1986).
114. G. Isaac and M. McCown, eds., *Human Origins: Louis Leaky and the East African Evidence*, Benjamin, Menlo Park, (1976).
115. F.J. Brown, R. Leaky, and A. Walker, *Early Homo erectus skeleton from west Lake Turkana, Kenya*, *Nature*, **316**, 788-92, (1985).
116. K.W. Butzer, *Archeology as Human Ecology*, Cambridge University Press, (1982).
117. A.T. Chamberlain and B.A. Wood, *Early hominid phylogeny*, *Journal of Human Evolution*, **16**, 119-33, (1987).
118. P. Mellars and C. Stringer, eds., *The Human Revolution: Behavioural and Biological Perspectives in the Origins of Modern Humans*, Edinburgh University Press, (1989).
119. G.C. Conroy, *Primate Evolution*, W.W. Norton, New York, (1990).
120. R.I.M. Dunbar, *Primate Social Systems*, Croom Helm, London, (1988).
121. B. Fagan, *The Great Journey: The Peopling of Ancient America*, Thames and Hudson, London, (1987).
122. R.A. Foley, ed., *Hominid Evolution and Community Ecology*, Academic Press, New York, (1984).
123. S.R. Binford and L.R. Binford, *Stone tools and human behavior*, *Scientific American*, **220**, 70-84, (1969).
124. G. Klein, *The Human Career, Human Biological and Cultural Origins*, University of Chicago Press, (1989).
125. B.F. Skinner and N. Chomsky, *Verbal behavior*, *Language*, **35** 26-58 (1959).
126. D. Bickerton, *The Roots of Language*, Karoma, Ann Arbor, Mich., (1981).
127. E. Lenneberg in *The Structure of Language: Readings in the Philosophy of Language*, J.A. Fodor and J.A. Katz editors, Prentice-Hall, Englewood Cliffs N.J., (1964).
128. S. Pinker, *Talk of genetics and visa versa*, *Nature*, **413**, 465-466, (2001).
129. S. Pinker, *Words and rules in the human brain*, *Nature*, **387**, 547-548, (1997).
130. M. Ruhelen, *The Origin of Language*, Wiley, New York, (1994).
131. C.B. Stringer and R. McKie, *African Exodus: The Origins of Modern Humanity*, Johnathan Cape, London (1996).

132. R.W. Sussman, *The Biological Basis of Human Behavior*, Prentice Hall, Englewood Cliffs, (1997).
133. D.P. Barash *Sociobiology and Behavior*, Elsevier, New York, (1977).
134. J.D. Carthy and F.J. Eblin, eds., *The Natural History of Aggression*, Academic Press, New York, (1964).
135. N.A. Chagnon and W. Irons, eds., *Evolutionary Biology and Human Social Behavior, an Anthropological Perspective*, Duxbury Press, N. Scituate, MA, (1979).
136. E. Danielson, *Vold, en Ond Arv?*, Gyldendal, Copenhagen, (1929).
137. M.R. Davie, *The Evolution of War*, Yale University Press, New Haven, CT, (1929).
138. T. Dobzhanski, *Mankind Evolving*, Yale University Press, New Haven, CT, (1962).
139. I. Eibl-Eibesfeldt, *Der Vorprogrammiert Mensch*, Molden, Vienna, (1973).
140. I. Eibl-Eibesfeldt, *Ethology, the Biology of Behavior*, Holt, Rinehart and Winston, New York, (1975).
141. I. Eibl-Eibesfeldt, *Liebe und Hass*, Molden, Vienna, (1973).
142. R.L. Holloway, *Primate Aggression: Territoriality and Xenophobia*, Academic Press, New York, (1974).
143. P. Kitcher, *Vaulting Ambition: Sociobiology and the Quest for Human Nature*, MIT Press, Cambridge, MA, (1985).
144. S.L.W. Mellen, *The Evolution of Love*, Freeman, Oxford, (1981).
145. A. Roe and G.G. Simpson, *Behavior and Evolution*, Yale University Press, New Haven, CT, (1958).
146. N.J. Smelser, *The Theory of Collective Behavior*, Free Press, New York, (1963).
147. R. Trivers, *Social Evolution*, Benjamin/Cummings, Menlo Park, CA, (1985).
148. W. Weiser, *Konrad Lorenz und seine Kritiker*, Piper, Munich, (1976).
149. W. Wickler, *Biologie der 10 Gebote*, Piper, Munich, (1971).
150. E.O. Wilson, *Sociobiology*, Harvard University Press (1975).
151. E.O. Wilson, *On Human Nature*, Bantam Books, New York, (1979).
152. C. Zahn-Waxler, *Altruism and Aggression: Biological and Social Origins*, Cambridge University Press, (1986).
153. J. Galtung, *A structural theory of aggression*, Journal of Peace Research, **1**, 95-119, (1964).
154. G.E. Kang, *Exogamy and peace relations of social units: A cross-cultural test*, Ethology, **18**, 85-99, (1979).
155. A. Montagu, *Man and Aggression*, Oxford University Press, New York, (1968).
156. W.A. Nesbitt, *Human Nature and War*, State Education Department of New York, Albany, (1973).
157. W. Suttles, *Subhuman and human fighting*, Anthropologica, **3**, 148-163, (1961).
158. V. Vale and Andrea Juno, editors, *Modern Primitives: An Investigation of Contemporary Adornment and Ritual*, San Francisco Re/Search, (1990).
159. R.A. Hinde, editor, *The Institution of War*, Cambridge University Press, (1991).
160. R.A. Hinde, *Individuals, Relationships and Culture: Links Between Ethology and the Social Sciences*, Cambridge University Press, (1987).
161. R.A. Hinde, *Ethology: Its Nature and Relationship With Other Sciences*

162. R.A. Hinde, *Animal Behaviour: A Synthesis of Ethology and Comparative Psychology*
163. R.A. Hinde, *Non-Verbal Communication*, Cambridge University Press, (1972).
164. R.A. Hinde, *Why Gods Persist: A Scientific Approach to Religion*, Routledge, London, (1999).
165. P.P.G. Bateson and R.A. Hinde, editors, *Growing Points in Ethology: Based on a Conference Sponsored by St. John's College and King's College, Cambridge*, Cambridge University Press, (1976).
166. R.A. Hinde, A.-N. Perret-Clermont and J. Stevenson-Hinde, editors, *Social Relationships and Cognitive Development*, Clarendon, Oxford, (1985).
167. R.A. Hinde and J. Stevenson-Hinde, editors, *Relationships Within Families: Mutual Influences*, Clarendon Press, Oxford, (1988).
168. P. Bateson, editor, *The Development and Integration of Behaviour: Essays in Honour of Robert Hinde*, Cambridge University Press, (1991).
169. C. Darwin, *The Expression of Emotions in Man and Animals*, The University of Chicago Press (1965).
170. P. Kropotkin, *Mutual Aid, A Factor in Evolution*, Walter Heinemann, London, (1902).
171. R.A. Fischer, *The Genetical Theory of Natural Selection*, Clarendon, Oxford, (1930).
172. J.B.S. Haldane, *Population genetics*, *New Biology* **18**, 34-51, (1955).
173. L. Margulis, *Symbiosis as a Source of Evolutionary Innovation: Speciation and Morphogenesis*, The MIT Press, (1991).
174. L. Margulis, *Symbiosis in Cell Evolution: Microbial Communities in the Archean and Proterozoic Eons*, W.H. Freeman, (1992).
175. N. Tinbergen, *The Study of Instinct*, Oxford University Press, (1951).
176. I. Eibl-Eibesfeldt, *The Biology of Peace and War*, Thames and Hudson, New York (1979).
177. E.O. Wilson, *On Human Nature*, Bantam Books, New York, (1979).
178. R.A. Hinde, *Biological Bases of Human Social Behavior*, McGraw-Hill, New York (1977).
179. R.A. Hinde, *Individuals, Relationships and Culture: Links Between Ethology and the Social Sciences*, Cambridge University Press, (1987).
180. W.M. Senner, editor, *The Origins of Writing*, University of Nebraska Press, Lincoln and London, (1989).
181. A. Robock, L. Oman, G. L. Stenchikov, O. B. Toon, C. Bardeen, and R. Turco, *Climatic consequences of regional nuclear conflicts*, *Atmospheric Chemistry and Physics*, Vol. 7, p. 2003-2012, (2007).
182. M. Mills, O. Toon, R. Turco, D. Kinnison, R. Garcia, *Massive global ozone loss predicted following regional nuclear conflict*, *Proceedings of the National Academy of Sciences (USA)*, vol. 105(14), pp. 5307-12, Apr 8, (2008).
183. O. Toon, A. Robock, and R. Turco, *The Environmental Consequences of Nuclear War*, *Physics Today*, vol. 61, No. 12, p. 37-42, (2008).

184. R. Turco, O. Toon, T. Ackermann, J. Pollack, and C. Sagan, *Nuclear Winter: Global consequences of multiple nuclear explosions*, Science, Vol. 222, No. 4630, pp. 1283-1292, December (1983).
185. A. Robock, L. Oman, G. Stenchikov, *Nuclear winter revisited with a modern climate model and current nuclear arsenals: Still catastrophic consequences*, Journal of Geophysical Research - Atmospheres, Vol. 112, No. D13, p. 4 of 14, (2007).
186. I. Helfand, *An Assessment of the Extent of Projected Global Famine Resulting From Limited, Regional Nuclear War*, International Physicians for the Prevention of Nuclear War, Physicians for Social Responsibility, Leeds, MA, (2007).
187. George P. Schultz, William J. Perry, Henry A. Kissinger and Sam Nunn, *A World Free of Nuclear Weapons*, The Wall Street Journal, January 4, 2007, page A15 and January 15, (2008), page A15.
188. Mikhail Gorbachev, *The Nuclear Threat*, The Wall Street Journal, January 30, (2007), page A15.
189. Massimo D'Alema, Gianfranco Fini, Giorgio La Malfa, Arturo Parisi and Francesco Calogero, *For a World Free of Nuclear Weapons*, Corriere Della Sera, July 24, (2008).
190. Hoover Institution, *Reykjavik Revisited; Steps Towards a World Free of Nuclear Weapons*, October, (2007).
191. Douglas Hurd, Malcolm Rifkind, David Owen and George Robertson, *Start Worrying and Learn to Ditch the Bomb*, The Times, June 30, (2008).
192. Des Brown, Secretary of State for Defense, UK, *Laying the Foundations for Multilateral Disarmament*, Geneva Conference on Disarmament, February 5, (2008).
193. Government of Norway, International Conference on *Achieving the Vision of a World Free of Nuclear Weapons*, Oslo, Norway, February 26-27, (2008).
194. Jonas Gahr Støre, Foreign Minister, Norway, *Statement at the Conference on Disarmament*, Geneva, March 4, (2008).
195. Anne-Grete Strøm-Erichsen, Defense Minister, Norway, *Emerging Opportunities for Nuclear Disarmament*, Pugwash Conference, Canada, July 11, (2008).
196. Kevin Rudd, Prime Minister, Australia, *International Commission on Nuclear Non-Proliferation and Disarmament*, Media Release, July 9, (2008).
197. Helmut Schmidt, Richard von Weizäcker, Egon Bahr and Hans-Dietrich Genscher, *Towards a Nuclear-Free World: a German View*, International Herald Tribune, January 9, (2009).
198. Hans M. Kristensen and Elliot Negin, *Support Growing for Removal of U.S. Nuclear Weapons from Europe*, Common Dreams Newscenter, first posted May 6, (2005).
199. David Krieger, *President-elect Obama and a World Free of Nuclear Weapons*, Nuclear Age Peace Foundation Website, (2008).
200. J.L. Henderson, *Hiroshima*, Longmans (1974).
201. A. Osada, *Children of the A-Bomb, The Testament of Boys and Girls of Hiroshima*, Putnam, New York (1963).
202. M. Hachiya, M.D., *Hiroshima Diary*, The University of North Carolina Press, Chapel Hill, N.C. (1955).
203. M. Yass, *Hiroshima*, G.P. Putnam's Sons, New York (1972).

204. R. Jungk, *Children of the Ashes*, Harcourt, Brace and World (1961).
205. B. Hirschfield, *A Cloud Over Hiroshima*, Baily Brothers and Swinfin Ltd. (1974).
206. J. Hersey, *Hiroshima*, Penguin Books Ltd. (1975).
207. R. Rhodes, *Dark Sun: The Making of the Hydrogen Bomb*, Simon and Schuster, New York, (1995)
208. R. Rhodes, *The Making of the Atomic Bomb*, Simon and Schuster, New York, (1988).
209. D.V. Babst et al., *Accidental Nuclear War: The Growing Peril*, Peace Research Institute, Dundas, Ontario, (1984).
210. S. Britten, *The Invisible Event: An Assessment of the Risk of Accidental or Unauthorized Detonation of Nuclear Weapons and of War by Miscalculation*, Menard Press, London, (1983).
211. M. Dando and P. Rogers, *The Death of Deterrence*, CND Publications, London, (1984).
212. N.F. Dixon, *On the Psychology of Military Incompetence*, Futura, London, (1976).
213. D. Frei and C. Catrina, *Risks of Unintentional Nuclear War*, United Nations, Geneva, (1982).
214. H. L'Etang, *Fit to Lead?*, Heinemann Medical, London, (1980).
215. SPANW, *Nuclear War by Mistake - Inevitable or Preventable?*, Swedish Physicians Against Nuclear War, Lulea, (1985).
216. J. Goldblat, *Nuclear Non-proliferation: The Why and the Wherefore*, (SIPRI Publications), Taylor and Francis, (1985).
217. J. Schear, ed., *Nuclear Weapons Proliferation and Nuclear Risk*, Gower, London, (1984).
218. D.P. Barash and J.E. Lipton, *Stop Nuclear War! A Handbook*, Grove Press, New York, (1982).
219. C.F. Barnaby and G.P. Thomas, eds., *The Nuclear Arms Race: Control or Catastrophe*, Francis Pinter, London, (1982).
220. L.R. Beres, *Apocalypse: Nuclear Catastrophe in World Politics*, Chicago University press, Chicago, IL, (1980).
221. F. Blackaby et al., eds., *No-first-use*, Taylor and Francis, London, (1984).
222. NS, ed., *New Statesman Papers on Destruction and Disarmament* (NS Report No. 3), New Statesman, London, (1981).
223. H. Caldicot, *Missile Envy: The Arms Race and Nuclear War*, William Morrow, New York, (1984).
224. R. Ehrlich, *Waging the Peace: The Technology and Politics of Nuclear Weapons*, State University of New York Press, Albany, NY, (1985).
225. W. Epstein, *The Prevention of Nuclear War: A United Nations Perspective*, Gunn and Hain, Cambridge, MA, (1984).
226. W. Epstein and T. Toyoda, eds., *A New Design for Nuclear Disarmament*, Spokesman, Nottingham, (1975).
227. G.F. Kennan, *The Nuclear Delusion*, Pantheon, New York, (1983).
228. R.J. Lifton and R. Falk, *Indefensible Weapons: The Political and Psychological Case Against Nuclearism*, Basic Books, New York, (1982).

229. J.R. Macy, *Despair and Personal Power in the Nuclear Age*, New Society Publishers, Philadelphia, PA, (1983).
230. A.S. Miller et al., eds., *Nuclear Weapons and Law*, Greenwood Press, Westport, CT, (1984).
231. MIT Coalition on Disarmament, eds., *The Nuclear Almanac: Confronting the Atom in War and Peace*, Addison-Wesley, Reading, MA, (1984).
232. UN, *Nuclear Weapons: Report of the Secretary-General of the United Nations*, United Nations, New York, (1980).
233. IC, *Proceedings of the Conference on Understanding Nuclear War*, Imperial College, London, (1980).
234. B. Russell, *Common Sense and Nuclear Warfare*, Allen and Unwin, London, (1959).
235. F. Barnaby, *The Nuclear Age*, Almqvist and Wiksell, Stockholm, (1974).
236. D. Albright, F. Berkhout and W. Walker, *Plutonium and Highly Enriched Uranium 1996: World Inventories, Capabilities and Policies*, Oxford University Press, Oxford, (1997).
237. G.T. Allison et al., *Avoiding Nuclear Anarchy: Containing the Threat of Loose Russian Nuclear Weapons and Fissile Material*, MIT Press, Cambridge MA, (1996).
238. B. Bailin, *The Making of the Indian Atomic Bomb: Science, Secrecy, and the Post-colonial State*, Zed Books, London, (1998).
239. P. Bidawi and A. Vanaik, *South Asia on a Short Fuse: Nuclear Politics and the Future of Global Disarmament*, Oxford University Press, Oxford, (2001).
240. F.A. Boyle, *The Criminality of Nuclear Deterrence: Could the U.S. War on Terrorism Go Nuclear?*, Clarity Press, Atlanta GA, (2002).
241. G. Burns, *The Atomic Papers: A Citizen's Guide to Selected Books and Articles on the Bomb, the Arms Race, Nuclear Power, the Peace Movement, and Related Issues*, Scarecrow Press, Metuchen NJ, (1984).
242. L. Butler, *A Voice of Reason*, The Bulletin of Atomic Scientists, **54**, 58-61, (1998).
243. R. Butler, *Fatal Choice: Nuclear Weapons and the Illusion of Missile Defense*, Westview Press, Boulder CO, (2001).
244. R.P. Carlisle (Ed.), *Encyclopedia of the Atomic Age*, Facts on File, New York, (2001).
245. G.A. Cheney, *Nuclear Proliferation: The Problems and Possibilities*, Franklin Watts, New York, (1999).
246. A. Cohen, *Israel and the Bomb*, Columbia University Press, New York, (1998).
247. S.J. Diehl and J.C. Moltz, *Nuclear Weapons and Nonproliferation: A Reference Handbook*, ABC-Clio Information Services, Santa Barbara CA, (2002).
248. H.A. Feiveson (Ed.), *The Nuclear Turning Point: A Blueprint for Deep Cuts and De-Alerting of Nuclear Weapons*, Brookings Institution Press, Washington D.C., (1999).
249. R. Hilsman, *From Nuclear Military Strategy to a World Without War: A History and a Proposal*, Praeger Publishers, Westport, (1999).
250. International Physicians for the Prevention of Nuclear War and The Institute for Energy and Environmental Research *Plutonium: Deadly Gold of the Nuclear Age*, International Physicians Press, Cambridge MA, (1992).

251. R.W. Jones and M.G. McDonough, *Tracking Nuclear Proliferation: A Guide in Maps and Charts, 1998*, The Carnegie Endowment for International Peace, Washington D.C., (1998).
252. R.J. Lifton and R. Falk, *Indefensible Weapons: The Political and Psychological Case Against Nuclearism*, Basic Books, New York, (1982).
253. R.E. Powaski, *March to Armageddon: The United States and the Nuclear Arms Race, 1939 to the Present*, Oxford University Press, (1987).
254. J. Rotblat, J. Steinberger and B. Udgaonkar (Eds.), *A Nuclear-Weapon-Free World: Desirable? Feasible?*, Westview Press, (1993).
255. The United Methodist Council of Bishops, *In Defense of Creation: The Nuclear Crisis and a Just Peace*, Graded Press, Nashville, (1986).
256. U.S. Congress Office of Technology Assessment (Ed.), *Dismantling the Bomb and Managing the Nuclear Materials*, U.S. Government Printing Office, Washington D.C., (1993).
257. S.R. Weart, *Nuclear Fear: A History of Images*, Harvard University Press, (1988).
258. P. Boyer, *By the Bomb's Early Light: American Thought and Culture at the Dawn of the Atomic Age*, University of North Carolina Press, (1985).
259. C. Perrow, *Normal Accidents: Living With High-Risk Technologies*, Basic Books, (1984).
260. P. Rogers, *The Risk of Nuclear Terrorism in Britain*, Oxford Research Group, Oxford, (2006).
261. MIT, *The Future of Nuclear Power: An Interdisciplinary MIT Study*, <http://web.mit.edu/nuclearpower> (2003).
262. Z. Mian and A. Glaser, *Life in a Nuclear Powered Crowd*, INES Newsletter No. 52, 9-13, April, (2006).
263. K. Bergeron, *Nuclear Weapons: The Death of No Dual-use*, Bulletin of the Atomic Scientists, 15-17, January, (2004).
264. E. Chivian, and others (eds.), *Last Aid: The Medical Dimensions of Nuclear War*, W.H. Freeman, San Francisco, (1982).
265. Medical Association's Board of Science and Education, *The Medical Effects of Nuclear War*, Wiley, (1983).
266. Kevin Rudd, Prime Minister, Australia, "International Commission on Nuclear Non-Proliferation and Disarmament", Media Release, July 9, 2008.
267. Global Zero, www.globalzero.org/paris-conference
268. Helmut Schmidt, Richard von Weizäcker, Egon Bahr and Hans-Dietrich Genscher, "Towards a Nuclear-Free World: a German View", International Herald Tribune, January 9, 2009.
269. Hans M. Kristensen and Elliot Negin, "Support Growing for Removal of U.S. Nuclear Weapons from Europe", Common Dreams Newscenter, first posted May 6, 2005.
270. David Krieger, "President-elect Obama and a World Free of Nuclear Weapons", Nuclear Age Peace Foundation Website, 2008.
271. J.L. Henderson, *Hiroshima*, Longmans (1974).

272. A. Osada, *Children of the A-Bomb, The Testament of Boys and Girls of Hiroshima*, Putnam, New York (1963).
273. M. Hachiya, M.D., *Hiroshima Diary*, The University of North Carolina Press, Chapel Hill, N.C. (1955).
274. M. Yass, *Hiroshima*, G.P. Putnam's Sons, New York (1972).
275. R. Jungk, *Children of the Ashes*, Harcourt, Brace and World (1961).
276. B. Hirschfield, *A Cloud Over Hiroshima*, Baily Brothers and Swinfin Ltd. (1974).
277. J. Hersey, *Hiroshima*, Penguin Books Ltd. (1975).
278. R. Rhodes, *Dark Sun: The Making of the Hydrogen Bomb*, Simon and Schuster, New York, (1995)
279. R. Rhodes, *The Making of the Atomic Bomb*, Simon and Schuster, New York, (1988).
280. D.V. Babst et al., *Accidental Nuclear War: The Growing Peril*, Peace Research Institute, Dundas, Ontario, (1984).
281. S. Britten, *The Invisible Event: An Assessment of the Risk of Accidental or Unauthorized Detonation of Nuclear Weapons and of War by Miscalculation*, Menard Press, London, (1983).
282. M. Dando and P. Rogers, *The Death of Deterrence*, CND Publications, London, (1984).
283. N.F. Dixon, *On the Psychology of Military Incompetence*, Futura, London, (1976).
284. D. Frei and C. Catrina, *Risks of Unintentional Nuclear War*, United Nations, Geneva, (1982).
285. H. L'Etang, *Fit to Lead?*, Heinemann Medical, London, (1980).
286. SPANW, *Nuclear War by Mistake - Inevitable or Preventable?*, Swedish Physicians Against Nuclear War, Lulea, (1985).
287. J. Goldblat, *Nuclear Non-proliferation: The Why and the Wherefore*, (SIPRI Publications), Taylor and Francis, (1985).
288. IAEA, *International Safeguards and the Non-proliferation of Nuclear Weapons*, International Atomic Energy Agency, Vienna, (1985).
289. J. Schear, ed., *Nuclear Weapons Proliferation and Nuclear Risk*, Gower, London, (1984).
290. D.P. Barash and J.E. Lipton, *Stop Nuclear War! A Handbook*, Grove Press, New York, (1982).
291. C.F. Barnaby and G.P. Thomas, eds., *The Nuclear Arms Race: Control or Catastrophe*, Francis Pinter, London, (1982).
292. L.R. Beres, *Apocalypse: Nuclear Catastrophe in World Politics*, Chicago University press, Chicago, IL, (1980).
293. F. Blackaby et al., eds., *No-first-use*, Taylor and Francis, London, (1984).
294. NS, ed., *New Statesman Papers on Destruction and Disarmament* (NS Report No. 3), New Statesman, London, (1981).
295. H. Caldicot, *Missile Envy: The Arms Race and Nuclear War*, William Morrow, New York, (1984).
296. R. Ehrlich, *Waging the Peace: The Technology and Politics of Nuclear Weapons*, State University of New York Press, Albany, NY, (1985).

297. W. Epstein, *The Prevention of Nuclear War: A United Nations Perspective*, Gunn and Hain, Cambridge, MA, (1984).
298. W. Epstein and T. Toyoda, eds., *A New Design for Nuclear Disarmament*, Spokesman, Nottingham, (1975).
299. G.F. Kennan, *The Nuclear Delusion*, Pantheon, New York, (1983).
300. R.J. Lifton and R. Falk, *Indefensible Weapons: The Political and Psychological Case Against Nuclearism*, Basic Books, New York, (1982).
301. J.R. Macy, *Despair and Personal Power in the Nuclear Age*, New Society Publishers, Philadelphia, PA, (1983).
302. A.S. Miller et al., eds., *Nuclear Weapons and Law*, Greenwood Press, Westport, CT, (1984).
303. MIT Coalition on Disarmament, eds., *The Nuclear Almanac: Confronting the Atom in War and Peace*, Addison-Wesley, Reading, MA, (1984).
304. UN, *Nuclear Weapons: Report of the Secretary-General of the United Nations*, United Nations, New York, (1980).
305. IC, *Proceedings of the Conference on Understanding Nuclear War*, Imperial College, London, (1980).
306. B. Russell, *Common Sense and Nuclear Warfare*, Allen and Unwin, London, (1959).
307. F. Barnaby, *The Nuclear Age*, Almqvist and Wiksell, Stockholm, (1974).
308. D. Albright, F. Berkhout and W. Walker, *Plutonium and Highly Enriched Uranium 1996: World Inventories, Capabilities and Policies*, Oxford University Press, Oxford, (1997).
309. G.T. Allison et al., *Avoiding Nuclear Anarchy: Containing the Threat of Loose Russian Nuclear Weapons and Fissile Material*, MIT Press, Cambridge MA, (1996).
310. B. Bailin, *The Making of the Indian Atomic Bomb: Science, Secrecy, and the Post-colonial State*, Zed Books, London, (1998).
311. G.K. Bertsch and S.R. Grillot, (Eds.), *Arms on the Market: Reducing the Risks of Proliferation in the Former Soviet Union*, Routledge, New York, (1998).
312. P. Bidawi and A. Vanaik, *South Asia on a Short Fuse: Nuclear Politics and the Future of Global Disarmament*, Oxford University Press, Oxford, (2001).
313. F.A. Boyle, *The Criminality of Nuclear Deterrence: Could the U.S. War on Terrorism Go Nuclear?*, Clarity Press, Atlanta GA, (2002).
314. G. Burns, *The Atomic Papers: A Citizen's Guide to Selected Books and Articles on the Bomb, the Arms Race, Nuclear Power, the Peace Movement, and Related Issues*, Scarecrow Press, Metuchen NJ, (1984).
315. L. Butler, *A Voice of Reason*, The Bulletin of Atomic Scientists, **54**, 58-61, (1998).
316. R. Butler, *Fatal Choice: Nuclear Weapons and the Illusion of Missile Defense*, Westview Press, Boulder CO, (2001).
317. R.P. Carlisle (Ed.), *Encyclopedia of the Atomic Age*, Facts on File, New York, (2001).
318. G.A. Cheney, *Nuclear Proliferation: The Problems and Possibilities*, Franklin Watts, New York, (1999).
319. A. Cohen, *Israel and the Bomb*, Columbia University Press, New York, (1998).

320. S.J. Diehl and J.C. Moltz, *Nuclear Weapons and Nonproliferation: A Reference Handbook*, ABC-Clio Information Services, Santa Barbara CA, (2002).
321. H.A. Feiveson (Ed.), *The Nuclear Turning Point: A Blueprint for Deep Cuts and De-Alerting of Nuclear Weapons*, Brookings Institution Press, Washington D.C., (1999).
322. R. Hilsman, *From Nuclear Military Strategy to a World Without War: A History and a Proposal*, Praeger Publishers, Westport, (1999).
323. International Physicians for the Prevention of Nuclear War and The Institute for Energy and Environmental Research *Plutonium: Deadly Gold of the Nuclear Age*, International Physicians Press, Cambridge MA, (1992).
324. R.W. Jones and M.G. McDonough, *Tracking Nuclear Proliferation: A Guide in Maps and Charts, 1998*, The Carnegie Endowment for International Peace, Washington D.C., (1998).
325. R.J. Lifton and R. Falk, *Indefensible Weapons: The Political and Psychological Case Against Nuclearism*, Basic Books, New York, (1982).
326. J. Rotblat, J. Steinberger and B. Udgaonkar (Eds.), *A Nuclear-Weapon-Free World: Desirable? Feasible?*, Westview Press, (1993).
327. The United Methodist Council of Bishops, *In Defense of Creation: The Nuclear Crisis and a Just Peace*, Graded Press, Nashville, (1986).
328. U.S. Congress Office of Technology Assessment (Ed.), *Dismantling the Bomb and Managing the Nuclear Materials*, U.S. Government Printing Office, Washington D.C., (1993).
329. S.R. Weart, *Nuclear Fear: A History of Images*, Harvard University Press, (1988).
330. P. Boyer, *By the Bomb's Early Light: American Thought and Culture at the Dawn of the Atomic Age*, University of North Carolina Press, (1985).
331. A. Makhijani and S. Saleska, *The Nuclear Power Deception: Nuclear Mythology From Electricity 'Too Cheap to Meter' to 'Inherently Safe' Reactors*, Apex Press, (1999).
332. C. Perrow, *Normal Accidents: Living With High-Risk Technologies*, Basic Books, (1984).
333. P. Rogers, *The Risk of Nuclear Terrorism in Britain*, Oxford Research Group, Oxford, (2006).
334. MIT, *The Future of Nuclear Power: An Interdisciplinary MIT Study*, <http://web.mit.edu/nuclearpow> (2003).
335. Z. Mian and A. Glaser, *Life in a Nuclear Powered Crowd*, INES Newsletter No. 52, 9-13, April, (2006).
336. E. Chivian, and others (eds.), *Last Aid: The Medical Dimensions of Nuclear War*, W.H. Freeman, San Fransisco, (1982).
337. P.B. Smith, J.D. Schilling and A.P. Haines, *Introduction and Summary*, in *Draft Report of the Pugwash Study Group: The World at the Crossroads*, Berlin, (1992).
338. World Resources Institute, *World Resources*, Oxford University Press, New York, (published annually).
339. J.R. Craig, D.J. Vaughan and B.J. Skinner, *Resources of the Earth: Origin, Use and Environmental Impact, Third Edition*, Prentice Hall, (2001).

340. W. Youngquist, *Geodesinies: The Inevitable Control of Earth Resources Over Nations and Individuals*, National Book Company, Portland Oregon, (1997).
341. M. Tanzer, *The Race for Resources. Continuing Struggles Over Minerals and Fuels*, Monthly Review Press, New York, (1980).
342. C.B. Reed, *Fuels, Minerals and Human Survival*, Ann Arbor Science Publishers Inc., Ann Arbor Michigan, (1975).
343. A.A. Bartlett, *Forgotten Fundamentals of the Energy Crisis*, American Journal of Physics, **46**, 876-888, (1978).
344. N. Gall, *We are Living Off Our Capital*, Forbes, September, (1986).

Chapter 13

THE CLIMATE EMERGENCY

13.1 Contrasting responses to the pandemic and the climate crisis

There is a remarkable contrast in the way that governments around the world have responded to the COVID-19 pandemic and the way that they have responded to the climate emergency. The pandemic, which indeed represents an extremely grave danger to humanity, has produced a massive global response. Borders have been closed, airlines have become virtually inoperative, industries, restaurants and entertainments have been closed, sporting events have been cancelled or postponed, people have been asked to stay at home and practice social distancing, and the everyday life of citizens around the world has been drastically changed.

By contrast, let us consider the threat that if immediate action is not taken to halt the extraction and use of fossil fuels, irreversible feedback loops will be initiated which will make catastrophic climate change inevitable despite human any human efforts to prevent it.

This threat is even more serious than the COVID-19 pandemic. Climate change could make much of the earth too hot for human life. It could produce a famine involving billions of people, rather than millions.

My own belief is that catastrophic climate change would not lead do the extinction of the human species; but I think that because much of the world would become uninhabitable, the global population of humans would be very much reduced.

How have governments responded to the climate emergency? A minority, for example the Scandinavian countries, have taken appropriate action. Most governments pay lip service to the emergency, but do not take effective action; and a few countries, such as the United States under Donald Trump, Bolsonaro's Brazil, and Saudi Arabia, deny that there is a climate emergency and actively sabotage action.

The world's net response has been totally inadequate. The Keeling Curve, which measures CO₂ concentrations in the atmosphere, continues to rise, and the rate of rising is even increasing.

What is the reason for this remarkable contrast in our response to two serious emergencies? We see clearly and respond to what is close to us, and are relatively indifferent to what is far away. We hear of people dying every day from the COVID-19 pandemic, and there is a danger that as many as 100 million people could die before it is over.

By contrast, although immediate climate action is needed today to avoid disaster, the worst consequences of climate change lie in the long-term future. Old people, like me, will not live to see massive deaths from starvation and overheating.

However, we have a responsibility to our children and grandchildren, and to all future generations. A large-scale global famine could occur by the middle of the present century, and children who are alive today could experience it.

13.2 Recovery from the pandemic offers climate action opportunities

When the COVID-19 pandemic is over, governments will be faced by the task of repairing the enormous economic damage that it has caused. The situation will be similar to the crisis that faced US President Franklin D. Roosevelt when he took office during the Great Depression of the 1930s. Roosevelt, encouraged by John Maynard Keynes, used federal funds to build much-needed infrastructure around the United States. His programs, the New Deal, ended the Great Depression in his country.

Today, the concept of a similar Green New Deal is being put forward globally. This concept visualizes government-sponsored programs aimed at simultaneously creating both jobs and urgently-needed renewable energy infrastructure. The Green New Deal programs could be administered in such a way as to correct social injustices.

13.3 Quick action is needed to save the long-term future

The worst effects of catastrophic climate change lie in the distant future, a century or even many centuries from the present; but disaster can only be avoided if quick action is taken. The nations of the world must act immediately to reduce and eventually stop the use of fossil fuels and the destruction of forests. If decisive action is not taken within the next few decades, feedback loops will make human intervention useless. These feedback loops include the albedo effect, the methane hydrate feedback loop, and the fact as tropical forests become drier, they become vulnerable to fires ignited by lightning. These fires accelerate the drying, and thus a feed-back loop is formed.

As time passes, and as the disastrous consequences of climate change become more apparent, the political will required for action will increase; but by that time it may be too late. We are rapidly approaching several crucial tipping points.

At present, the average global rate of use of primary energy is roughly 2 kW_t per person.

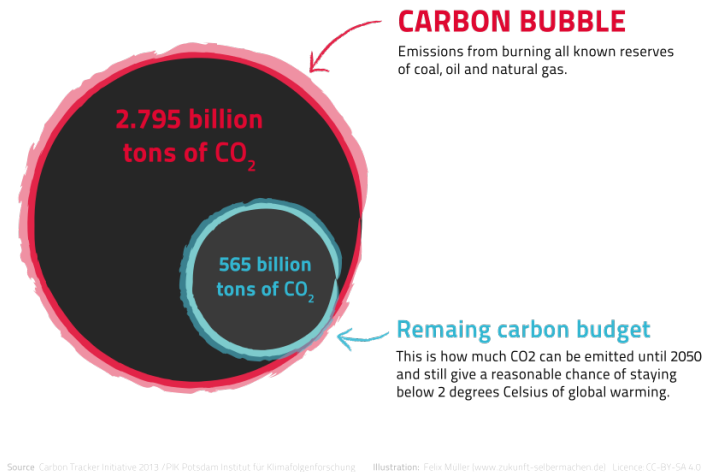

Figure 13.1: The Carbon Bubble according to data by the Carbon Tracker Initiative 2013. In order to avoid tipping points that will make human attempts to avoid catastrophic climate change useless, we must leave most of the known fossil fuel reserves in the ground!

In North America, the rate is 12 kW_t per capita, while in Europe, the figure is 6 kW_t. In Bangladesh, it is only 0.2 kW_t. This wide variation implies that considerable energy savings are possible, through changes in lifestyle, and through energy efficiency.

13.4 Is the transition to 100% renewable energy possible?

If we ask whether the transition to 100% renewable energy is possible, the answer is very simple: It is not only possible; it is inevitable! This is because the supply of fossil fuels is finite, and at the present rate of use they will be exhausted in less than a century. While the transition to 100% renewables is inevitable, the vitally important point to remember is that if we are to avoid disaster, the transition must come quickly.

| | Reserves | 2005 rate of use | Years remaining |
|-------------|----------|------------------|-----------------|
| Coal | 780 TWy | 3.5 TW | 217 years |
| Oil | 250 TWy | 6.0 TW | 42 years |
| Natural gas | 250 TWy | 3.7 TW | 68 years |
| Total | 1260 TWy | 13.2 TW | (95 years) |

| Year | Demand | Population | Per Capita |
|------|---------|------------|------------|
| 1980 | 9.48 TW | 4.45 bil. | 2.13 kW |
| 1985 | 10.3 TW | 4.84 bil. | 2.11 kW |
| 1990 | 11.6 TW | 5.99 bil. | 2.20 kW |
| 1995 | 12.3 TW | 5.68 bil. | 2.16 kW |
| 2003 | 14.1 TW | 6.30 bil. | 2.23 kW |
| 2010 | 17.1 TW | 6.84 bil. | 2.50 kW |
| 2015 | 18.9 TW | 7.23 bil. | 2.58 kW |
| 2020 | 20.5 TW | 7.61 bil. | 2.70 kW |
| 2025 | 22.3 TW | 7.91 bil. | 2.82 kW |
| 2030 | 24.2 TW | 8.30 bil. | 2.93 kW |

In this book, we will use kilowatts (kW), megawatts (MW) and terawatts (TW) as the units in which we discuss the rate of use of energy. A megawatt is equal to a thousand kilowatts or a million watts. A terawatt is equal to a thousand megawatts, or a million kilowatts or a billion (1,000,000,000) watts. A citizen of the European Union uses energy at the rate of about 6 kilowatts, while in North America, the rate of energy use is double that amount. The global average rate of energy use is a little over 2 kilowatts. Since there are now 7.5 billion people in the world, our present rate of energy use is roughly 15 terawatts,

The total available energy from fossil fuels can be measured in terawatt.years (TWy). Rough estimates of global coal reserves of coal, oil and natural gas are given by the table shown above.

The present rate of use of fossil fuels is greater than the 2005 rate shown in the table, and the remaining reserves are smaller than those shown. It is assumed that as oil becomes exhausted, coal will be converted into liquid fuels, as was done in Germany during World War II.

A second table, shown below, illustrates the historical and projected total global energy demand as a function of time between 1980 and 2030. In this slightly out-of-date table, the last year using historical data is 2003, later years being estimates based on projections.

Notice that the per capita energy use is almost constant. Our rapidly growing demand for energy is primarily the result of the world's rapidly growing population of humans. It would be wise to stabilize human populations because of the threat of human-caused ecological catastrophes and the danger of an extremely large-scale famine, involving billions of people rather than millions. Such a famine is threatened because growing populations require a growing food supply, climate changes threaten agriculture through droughts, melting glaciers and loss of agricultural land. The end of the fossil fuel era will also mean the end of high-yield petroleum-based agriculture.

The rate of growth of renewable energy

There is reason for hope that even the high energy demands show in the second table can be met by renewables. The basis of this hope can be found in the extremely high present rate of growth of renewable energy, and in the remarkable properties of exponential growth. According to figures recently released by the Earth Policy Institute, the global installed photovoltaic capacity is currently able to deliver 242,000 megawatts, and it is increasing at the rate of 27.8% per year. Wind energy can now deliver 370,000 megawatts, and it is increasing at the rate of roughly 20% per year.

Because of the astonishing properties of exponential growth, we can calculate that if these growth rates are maintained, renewable energy can give us 24.8 terawatts within only 15 years! This is far more than the world's present use of all forms of energy.

13.5 Renewables are now much cheaper than fossil fuels!

According to an article written by Megan Darby and published in *The Guardian* on 26 January, 2016, "Solar power costs are tumbling so fast the technology is likely to fast outstrip mainstream energy forecasts.

"That is the conclusion of Oxford University researchers, based on a new forecasting

model published in *Research Policy*¹.

“Commercial prices have fallen by 58% since 2012 and by 16

“Since the 1980s, panels to generate electricity from sunshine have got 10% cheaper each year. That is likely to continue, the study said, putting solar on course to meet 20% of global energy needs by 2027.’ ’

Solar energy

Unlike the burning of fossil fuels, renewables like solar energy do not release pollutants into the atmosphere. In China, public opinion has shifted in favor of renewables because of air pollution in cities.

Photovoltaic cells

The price of solar photovoltaic panels has declined 99 percent over the last four decades, from \$74 a watt in 1972 to less than 70 cents a watt in 2014.

Between 2009 and 2014, solar panel prices dropped by three fourths, helping global PV installations grow 50 percent per year.

Deutsche Bank notes that as of early 2014, solar PV was already competitive with average residential, commercial or industrial electricity rates in 14 countries, and in California - even without subsidies. By late 2014 there were nearly 600,000 individual PV systems in the United States, almost twice as many as in 2012. This number may well pass 1 million in 2016.

In 2013, just 12 percent of U.S homebuilders offered solar panels as an option for new single-family homes. More than half of them anticipate doing so by 2016. Four of the top five U.S. home construction firms - DR Horton, Lennar Corp, PulteGroup and KB Home - now automatically include solar panels on every new house in certain markets.

In 2007 there were only 8,000 rooftop solar installations in coal-heavy Australia; now there are over a million.

Saudi Arabia has 41,000 megawatts of solar PV operating, under construction and planned - enough to generate up to two thirds of the country's electricity.

For the roughly 1.3 billion people without access to electricity, it is now often cheaper and more efficient simply to install solar panels rooftop-by-rooftop than to build a central power plant and transmission infrastructure.

Wind energy

Over the past decade, world wind power capacity grew more than 20 percent a year, its increase driven by its many attractive features, by public policies supporting its expansion, and by falling costs.

¹<http://www.sciencedirect.com/science/article/pii/S0048733315001699>

By the end of 2014, global wind generating capacity totaled 369,000 megawatts, enough to power more than 90 million U.S. homes. Wind currently has a big lead on solar PV, which has enough worldwide capacity to power roughly 30 million U.S. homes.

China is now generating more electricity from wind farms than from nuclear plants, and should have little trouble meeting its official 2020 wind power goal of 200,000 megawatts. For perspective, that would be enough to satisfy the annual electricity needs of Brazil.

In nine U.S. states, wind provides at least 12 percent of electricity. Iowa and South Dakota are each generating more than one quarter of their electricity from wind.

In the Midwestern United States, contracts for wind power are being signed at a price of 2.5 cents per kilowatt-hour (kWh), which compares with the nationwide average grid price of 10-12 cents per kWh.

Although a wind farm can cover many square miles, turbines occupy little land. Coupled with access roads and other permanent features, a wind farm's footprint typically comes to just over 1 percent of the total land area covered by the project.

Wind energy yield per acre is off the charts. For example, a farmer in northern Iowa could plant an acre in corn that would yield enough grain to produce roughly \$1,000 worth of fuel-grade ethanol per year, or the farmer could put on that same acre a turbine that generates \$300,000 worth of electricity per year. Farmers typically receive \$3,000 to \$10,000 per turbine each year in royalties. As wind farms spread across the U.S. Great Plains, wind royalties for many ranchers will exceed their earnings from cattle sales.

The problem of intermittency

Many forms of renewable energy encounter the problem of intermittency. For example, on windy days, Denmark's windmills generate more than enough electricity to meet the needs of the country, but on days when the wind is less strong, the electrical energy generated is insufficient. Denmark solves this problem by selling surplus electrical power to Germany on windy days, and buying power from hydroelectric-rich Norway on less windy days.

The problem of intermittency can alternatively be solved by pumping water to uphill reservoirs when the wind is strong, and letting the stored water drive turbines when the wind is weak. The problem of intermittency can also be solved with lithium ion storage batteries, by splitting water into hydrogen and oxygen, or by using other types of fuel cells.

Developing countries: No need for grids

When cell phones came into general use, developing countries with no telephone networks were able to use the new technology through satellites, thus jumping over the need for country-wide telephone lines. Similarly, village solar or wind installations in the developing countries can supply power locally, bypassing the need for a grid.

13.6 An economic tipping point

Renewables are now cheaper than fossil fuels

Solar energy and wind energy have recently become cheaper than fossil fuels. Thus a tipping point has been passed. From now on, despite frantic efforts of giant fossil fuel corporations to prevent it from happening, the transition to 100% renewable energy will be driven by economic forces alone.

Subsidies to the fossil fuel industry

<http://www.imf.org/en/News/Articles/2015/09/28/04/53/sonew070215a>
<http://priceofoil.org/fossil-fuel-subsidies/>

13.7 An unprecedented investment opportunity

Investment in electric vehicles

On July 5, 2017, the Volvo Car Group made the following announcement: ²

“Volvo Cars, the premium car maker, has announced that every Volvo it launches from 2019 will have an electric motor, marking the historic end of cars that only have an internal combustion engine (ICE) and placing electrification at the core of its future business.

“The announcement represents one of the most significant moves by any car maker to embrace electrification and highlights how over a century after the invention of the internal combustion engine electrification is paving the way for a new chapter in automotive history.

“This is about the customer,” said Håkan Samuelsson, president and chief executive. “People increasingly demand electrified cars and we want to respond to our customers’ current and future needs. You can now pick and choose whichever electrified Volvo you wish.”

“Volvo Cars will introduce a portfolio of electrified cars across its model range, embracing fully electric cars, plug in hybrid cars and mild hybrid cars.

“It will launch five fully electric cars between 2019 and 2021, three of which will be Volvo models and two of which will be high performance electrified cars from Polestar, Volvo Cars’ performance car arm. Full details of these models will be announced at a later date.”

The electric vehicle investment opportunity was also illustrated by the 2017 vote of Germany’s Bundesrat to ban the manufacture of internal combustion engines after 2030 ³.

The article announcing the vote adds that “It’s a strong statement in a nation where the auto industry is one of the largest sectors of the economy; Germany produces more

²<https://www.media.volvocars.com/global/en-gb/media/pressreleases/210058/volvo-cars-to-go-all-electric>

³<https://arstechnica.com/cars/2016/10/germanys-bundesrat-votes-to-ban-the-internal-combustion-engine-by-2030/>

automobiles than any other country in Europe and is the third largest in the world. The resolution passed by the Bundesrat calls on the European Commission (the executive arm of the European Union) to 'evaluate the recent tax and contribution practices of Member States on their effectiveness in promoting zero-emission mobility,' which many are taking to mean an end to the lower levels of tax currently levied on diesel fuel across Europe."

France plans to end the sale of vehicles powered by gasoline and diesel by 2040, environment minister Nicolas Hulot announced recently.

Hulot made the announcement on Thursday, June 13, 2017, in Paris as he launched the country's new Climate Plan to accelerate the transition to clean energy and to meet its targets under the Paris climate agreement.

To ease the transition, Hulot said the French government will offer tax incentives to replace fossil-fuel burning cars with clean alternatives.

Furthermore, the government of India has recently announced its intention to only have electric vehicles by 2030⁴. This hugely ambitious plan was announced during the 2017 Confederation of Indian Industry Annual Session. Besides the avoidance of climate change, which might make many regions of India uninhabitable, the motive for replacing 28 million combustion engine vehicles by electric ones was the severe air pollution from which India suffers. Severe air pollution also motivates efforts by the government of China to promote the transition to electric vehicles.

The governments of Norway and the Netherlands have taken steps towards banning the internal combustion engine⁵. Both the upper and lower houses of the Netherlands' government voted to ban cars driven by internal combustion engines by 2025, the same year in which Norway plans to sell nothing but zero-emission vehicles.

In a report commissioned by the investment bankers Cowan & Co, managing director and senior research analyst Jeffrey Osborne, predicted that electric vehicles will cost less than gasoline-powered cars by the early- to mid-2020s due to falling battery prices as well as the costs that traditional carmakers will incur as they comply to new fuel-efficiency standards. Osbourne pointed out that a number of major car brands are hopping onto the electric bandwagon to compete in a space carved out by industry disrupter, Tesla.

"We see the competitive tides shifting in 2019 and beyond as European [car makers] roiled by the diesel scandal and loss of share to Tesla in the high margin luxury segment step on the gas and accelerate the pace of EV introductions", he wrote.

Bloomberg New Energy Finance reported similar predictions: "Falling battery costs will mean electric vehicles will also be cheaper to buy in the U.S. and Europe as soon as 2025," the report said. "Batteries currently account for about half the cost of EVs, and their prices will fall by about 77 percent between 2016 and 2030."

In October, 2017, General Motors unveiled plans to roll out 20 new entirely electric car models by 2023, with two of the new EVs coming out in the next 18 months. Meanwhile, Ford announced the creation of "Team Edison," intended to accelerate the company's EV

⁴<https://www.greentechmedia.com/articles/read/what-country-will-become-the-first-to-ban-internal-combustion-cars>

⁵<http://www.prnewswire.com/news-releases/the-dutch-revolution-in-smart-charging-of-electric-vehicles-597268791.html>

development and partnership work. The name, is “seemingly in direct response to Elon Musk’s Tesla, which recently surpassed Ford’s market capitalization.”

Tesla’s Chairman, highly successful inventor and entrepreneur Elon Musk, has made massive investments in factories manufacturing electric vehicles, improved lithium ion storage cells, and photovoltaic panels, as will be discussed in Chapter 2.

Investment in wind turbine energy

In Denmark, the wind turbine industry contributes substantially to the country’s positive balance of payments. According to Wikipedia, “The Danish wind turbine industry is the world’s largest. Around 90% of the national output is exported, and Danish companies accounted for 38% of the world turbine market in 2003, when the industry employed some 20,000 people and had a turnover of around 3 billion euro.”

Denmark’s two largest wind turbine manufacturers are Vestas and Simiens Wind Power. Vestas employs more than 21000 people globally. In February 2016, Vestas got its largest order of 1,000 MW (278 x 3.6 MW) for the Fosen project near Trondheim in Norway. It costs DKK 11 billion, and should deliver 3.4 TWh per year.

In 2015 Siemens Wind had a combined market share of 63% of European offshore wind turbines (nearly 75% in 2009 by capacity and number). In 2011, Siemens Wind Power had 6.3% share of the world wind turbine market, and was the second largest in 2014.

In many countries, including Australia, Canada, Denmark, Germany, India, The Netherlands, United Kingdom, and United States, wind turbine cooperatives have sprung up. In these cooperatives, communities share the costs and profits of wind turbine projects. For example, the Hepburn Wind Project in Victoria, Australia, owns two 2MW wind turbines which produce enough power for 2,300 households.

Investment in solar energy

Global revenues from solar photovoltaic installations are expected to reach \$1.2 trillion between the present and 2024 according to a recent article⁶

Another article⁷ states that “The global electric power industry is evolving into a model that offers more diversity, both in terms of generation and in the ownership of generation assets, and solar PV is one technology at the head of this change. Following years of unsustainable pricing and oversupply, demand for solar PV systems has finally caught up, with 2015 expected to be the year when the global solar PV market shifts and starts to compete with other technologies. According to a recent report from Navigant Research, global revenue from solar PV installations is expected to total more than \$1.2 trillion from 2015 to 2024.”

⁶<https://cleantechnica.com/2016/01/25/global-revenue-solar-pv-installations-expected-reach-1-2-trillion/>

⁷<http://www.navigantresearch.com/newsroom/global-revenue-from-solar-pv-installations-is-expected-to-total-more-than-1-2-trillion-from-2015-to-2024>

13.8 For creating jobs, renewables beat fossil fuels

Here are some excerpts from a 2016 report issued by the Solar Foundation:

- One out of every 50 new jobs added in the United States in 2016 was created by the solar industry, representing 2 percent of all new jobs.
- Solar jobs in the United States have increased at least 20 percent per year for the past four years, and jobs have nearly tripled since the first Solar Jobs Census was released in 2010.
- Over the next 12 months, employers surveyed expect one out of every 50 new jobs added in the United States in 2016 was created by the solar industry, representing 2 percent of all new jobs.
- In 2016, the five states with the most solar jobs were California, Massachusetts, Texas, Nevada, and Florida.
- The solar industry added \$84 billion to the US GDP in 2016 to see total solar industry employment increase by 10 percent to 286,335 solar workers.
- The solar industry added \$84 billion to the US GDP in 2016.

13.9 The Stern Review

Background of the Stern Review

The Stern Review on the Economics of Climate Change is a 700 page document commissioned by the government of the United Kingdom and released on 30 October, 2006. The research behind this report was conducted by a team led by Nicolas Stern (Baron Stern of Brentford), chair of the Grantham Research Institute on Climate Change and the Environment.

The Stern Review discusses the catastrophic climate change which will result if prompt action is not taken, and it proposes that 1% of global GDP be used annually to prevent such disasters. In 2014, the global GDP was estimated to be 77.9 trillion dollars, so that the 1% investment in renewable energy recommended by Lord Stern and his research team would have amounted to nearly a trillion dollars.

The Middle East

According to current estimates, 81.5% of the world's proven crude oil reserves are located in OPEC Member Countries, with the bulk of OPEC oil reserves in the Middle East, amounting to 65.5% of the OPEC total.

China

China's large reserves of coal lie near to the surface, and are thus very easily accessible. Mining of coal has driven the country's rapid industrial growth, but it has also produced a severe public health problem because of air pollution.

In April, 2017, China's rate of economic growth was 6.9%⁸. This rate of growth, if continued, would mean that China's economy would double every ten years. and increase by a factor of 1024 every century. Obviously this is impossible. Never-ending economic growth on a finite planet is a logical absurdity. China's high economic growth rate, is driven by its use of coal, and this must quickly stop if ecological disaster is to be avoided.

India

The MIT Technology Review recently published an important article entitled *India's Energy Crisis*⁹.

The article makes alarming reading in view of the world's urgent need to make a very rapid transition from fossil fuels to 100% renewable energy. We must make this change quickly in order to avoid a tipping point beyond which catastrophic climate change will be unavoidable.

The MIT article states that "Since he took power in May, 2014, Prime Minister Narendra Modi has made universal access to electricity a key part of his administration's ambitions. At the same time, he has pledged to help lead international efforts to limit climate change. Among other plans, he has promised to increase India's total power generating capacity to 175 gigawatts, including 100 gigawatts of solar, by 2022. (That's about the total power generation of Germany.)"

However India plans to expand its industrial economy, and to do this, it is planning to very much increase its domestic production and use of coal. The MIT article continues, pointing out that

However India plans to expand its industrial economy, and to do this, it is planning to very much increase its domestic production and use of coal. The MIT article continues, pointing out that "Such growth would easily swamp efforts elsewhere in the world to curtail carbon emissions, dooming any chance to head off the dire effects of global climate change. (Overall, the world will need to reduce its current annual emissions of 40 billion tons by 40 to 70 percent between now and 2050.) By 2050, India will have roughly 20 percent of the world's population. If those people rely heavily on fossil fuels such as coal to expand the economy and raise their living standards to the level people in the rich world have enjoyed for the last 50 years, the result will be a climate catastrophe regardless of anything the United States or even China does to decrease its emissions. Reversing these trends will require radical transformations in two main areas: how India produces electricity, and how it distributes it."

⁸<https://tradingeconomics.com/china/gdp-growth-annual>

⁹<http://www.technologyreview.com/featuredstory/542091/indias-energy-crisis/>

The Indian Minister of Power, Piyush Goyal, is an enthusiastic supporter of renewable energy expansion, but he also supports, with equal enthusiasm, the large-scale expansion of domestic coal production in India.

Meanwhile, the consequences of global warming are being felt by the people of India. For example, last May, a heat wave killed over 1,400 people and melted asphalt streets.¹⁰

Have India's economic planners really thought about the long-term future? Have they considered the fact that drastic climate change could make India completely uninhabitable?

Russia

According to Wikipedia, "The petroleum industry in Russia is one of the largest in the world. Russia has the largest reserves, and is the largest exporter, of natural gas. It has the second largest coal reserves, the eighth largest oil reserves, and is one of the largest producer of oil. It is the third largest energy user."

One of the difficulties of reducing Russia's fossil fuel production is that the Russian economy depends so heavily on its oil and gas industries. Many European countries also depend on natural gas from Russia for winter heating of homes and workplaces.

North America

Canadian oil sands

Canada's oil-sands deposits contain an amount of carbon comparable to the world's total reserves of conventional oil. Oil is currently being extracted by methods that release four times as much carbon into the atmosphere as is contained in the refined oil from the deposits. Nevertheless, the government of Canada wholeheartedly supports extraction of oil from the tar sands.

The position of the Canadian government has been strongly criticized by leading climate scientist Professor James Hansen. A recent article in *The Guardian*¹¹, reported him as saying; "To leave our children with a manageable situation, we need to leave the unconventional fuel in the ground. Canada's ministers are acting as salesmen for those people who will gain from the profits of that industry. But I don't think they are looking after the rights and wellbeing of the population as a whole.

"The thing we are facing overall is that the fossil fuel industry has so much money that they are buying off governments. Our democracies are seriously handicapped by the money that is driving decisions in Washington and other capitals."

Fracking in the United States

According to the US Department of Energy (DOE), in 2013 at least two million oil and gas wells in the US have been hydraulically fractured, and that of new wells being drilled,

¹⁰<https://www.rt.com/news/262641-india-heat-wave-killed/>

¹¹<https://www.theguardian.com/environment/2013/may/19/tar-sands-exploitation-climate-scientist>

up to 95% are hydraulically fractured. The output from these wells makes up 43% of the oil production and 67% of the natural gas production in the United States.

Because of earthquakes and poisoning of water supplies caused by fracking, this practice has been banned by several states in the US, and nine countries or regions in Europe: France, Bulgaria, Roumania, Germany, The Czech Republic, Luxembourg, Northern Ireland, Spain and Switzerland,

Latin America

Venezuela's Belt of Tar

The Orinoco River Basin in Venezuela contains the world's largest deposit of extra-heavy oil and tar. The amount of carbon contained in this deposit is comparable to the carbon content of all the world's known reserves of conventional oil, and also larger than the carbon contained in Canada's oil sands.

The Belt of Tar follows the line of the Orinoco river. It is approximately 600 kilometers (370 mi) from east to west, and 70 kilometers (43 mi) from north to south, with an area about 55,314 square kilometers (21,357 sq mi). The Orinoco deposit is estimated to contain 1.2 trillion barrels of extra-heavy oil.

The government of Venezuela has no plans for halting extraction from the Belt of Tar. On the contrary, detailed plans have been made for expanded exploitation of the deposit¹².

Extraction of oil in Brazil

According to a recent article in *The Guardian*¹³ "The discovery of tens of billions of barrels of oil in fields far off the coast of Rio de Janeiro was billed as one of the biggest finds of this century when it was announced in 2006.

"Many hoped it would deliver a bonanza for education and health and make Brazil one of world's major economies.

"But with the country's biggest energy company, Petrobras, mired in debt and scandal, the low price of oil and the dangers of a second Deepwater Horizon, the viability of this massive undertaking has never been under more scrutiny."

The Brazilian offshore deposits are called "presalt oil", since they lie under a thick layer of salt deposits.

According to the article in *The Guardian*, "Suggestions by climate campaigners that this reservoir of fossil fuel is a 'carbon bomb' that should be left in the ground, are dismissed as hypocrisy."

The article quotes the geologist who discovered the off-shore fields as saying "The big countries of the world today developed without any concern for the environment. The

¹²<https://en.wikipedia.org/wiki/PDVSA>

¹³<https://www.theguardian.com/environment/ng-interactive/2015/jun/25/brazils-gamble-on-deep-water-oil-guanabara-bay>

base of US development was the oil in the Gulf of Mexico. The base of the UK's industrial revolution was coal. How can they now say we can't use our own pre-salt?"

The European Union

Coal in Germany and Poland

In 2016, Germany produced 176,100,000 tonnes of coal while Poland produced 131,100,000 tonnes. In the past, Poland experienced severe ecological effects from acid rain due to the burning of coal. Polish forests were destroyed by the effects of acid rain, and the facades of statues and buildings in Krakow and elsewhere were dissolved by the acid. Today the situation is improving, but the two countries are still heavily dependant on coal.

North Sea oil

According to Wikipedia, "The British and Norwegian sections hold most of the remainder of the large oil reserves. It is estimated that the Norwegian section alone contains 54% of the sea's oil reserves and 45% of its gas reserves- More than half of the North Sea oil reserves have been extracted, according to official sources in both Norway and the UK. For Norway, the Norwegian Petroleum Directorate [28] gives a figure of 4,601 million cubic meters of oil (corresponding to 29 billion barrels) for the Norwegian North Sea alone (excluding smaller reserves in Norwegian Sea and Barents Sea) of which 2,778 million cubic meters (60%) has already been produced prior to January 2007. UK sources give a range of estimates of reserves, but even using the most optimistic 'maximum' estimate of ultimate recovery, 76% had been recovered at end 2010.[citation needed] Note the UK figure includes fields which are not in the North Sea (onshore, West of Shetland).

13.10 Major producers of fossil fuels

The top 20 oil-producing nations in 2016

Wikipedia's article entitles *List of countries by oil production* gives information shown in the table below. In the table, which is based on data from the International Energy Agency, production is measured in barrels of oil per day

| | | |
|----|----------------------|------------|
| 1 | Russia | 10,551,497 |
| 2 | Saudi Arabia | 10,460,710 |
| 3 | United States | 8,875,817 |
| 4 | Iraq | 4,451,516 |
| 5 | Iran | 3,990,956 |
| 6 | China | 3,980,650 |
| 7 | Canada | 3,662,694 |
| 8 | United Arab Emirates | 3,106,077 |
| 9 | Kuwait | 2,923,825 |
| 10 | Brazil | 2,515,459 |
| 11 | Venezuela | 2,276,967 |
| 12 | Mexico | 2,186,877 |
| 13 | Nigeria | 1,999,885 |
| 14 | Angola | 1,769,615 |
| 15 | Norway | 1,647,975 |
| 16 | Kazakhstan | 1,595,199 |
| 17 | Qatar | 1,522,902 |
| 18 | Algeria | 1,348,361 |
| 19 | Oman | 1,006,841 |
| 20 | United Kingdom | 939,760 |

The top 10 coal producing nations in 2016

Wikipedia gives a similar list of coal producing nations. Only the top 10 are shown here, since these countries completely dominate global coal production. In the table, production is measured in millions of tonnes per year.

| | | |
|----|---------------|---------|
| 1 | China | 3411.0 |
| 2 | India | 692.4 |
| 3 | United States | 660.6 |
| 4 | Australia | 492.8 |
| 5 | Indonesia | 434.0 |
| 6 | Russia | 385.4 |
| 7 | South Africa | 251.3 |
| 8 | Germany | 176.1 |
| 9 | Poland | 131.1 |
| 10 | Kazakhstan | 102.4 |
| | World | 7,460.4 |

The world production of coal is falling. In 2014 it was 8,164.9 tonnes, in 2015, 7,861.1 tonnes, and in 2016 7,460.4 tonnes. Nevertheless, global production of coal remains worryingly high. If catastrophic climate change is to be avoided, it must stop altogether within one or two decades. At the moment the world is still producing roughly 1 tonne of coal per capita each year.

List of countries by natural gas production

Here is a similar table for natural gas. Production is measured in m³ per year. The final column indicates the date of the data.

| | | | |
|----|---------------|-------------------|------|
| 1 | United States | 728,200,000,000 | 2014 |
| 2 | Russia | 578,700,000,000 | 2014 |
| 3 | Iran | 438,000,000,000 | 2017 |
| 4 | Canada | 143,100,000,000 | 2012 |
| 5 | Qatar | 133,200,000,000 | 2011 |
| 6 | Norway | 114,700,000,000 | 2012 |
| 7 | China | 107,200,000,000 | 2012 |
| 8 | Saudi Arabia | 103,200,000,000 | 2012 |
| 9 | Algeria | 82,760,000,000 | 2011 |
| 10 | Netherlands | 80,780,000,000 | 2012 |
| | World | 4,359,000,000,000 | 2010 |

13.11 Blood for oil

There is a close relationship between petroleum and war. James A. Paul, Executive Director of the Global Policy Forum, has described this relationship very clearly in the following words:

“Modern warfare particularly depends on oil, because virtually all weapons systems rely on oil-based fuel - tanks, trucks, armored vehicles, self-propelled artillery pieces, airplanes, and naval ships. For this reason, the governments and general staffs of powerful nations seek to ensure a steady supply of oil during wartime, to fuel oil-hungry military forces in far-flung operational theaters.”

“Just as governments like the US and UK need oil companies to secure fuel for their global war-making capacity, so the oil companies need their governments to secure control over global oilfields and transportation routes. It is no accident, then, that the world’s largest oil companies are located in the world’s most powerful countries.”

“Almost all of the world’s oil-producing countries have suffered abusive, corrupt and undemocratic governments and an absence of durable development. Indonesia, Saudi Arabia, Libya, Iraq, Iran, Angola, Colombia, Venezuela, Kuwait, Mexico, Algeria - these and many other oil producers have a sad record, which includes dictatorships installed from abroad, bloody coups engineered by foreign intelligence services, militarization of government and intolerant right-wing nationalism.”

The resource curse

The way in which the industrialized countries maintain their control over less developed nations can be illustrated by the “resource curse”, i.e. the fact that resource-rich developing countries are no better off economically than those that lack resources, but are cursed with

corrupt and undemocratic governments. This is because foreign corporations extracting local resources under unfair agreements exist in a symbiotic relationship with corrupt local officials.

One might think that taxation of foreign resource-extracting firms would provide developing countries with large incomes. However, there is at present no international law governing multinational tax arrangements. These are usually agreed to on a bilateral basis, and the industrialized countries have stronger bargaining powers in arranging the bilateral agreements.

13.12 Fossil fuel extraction must stop!

“Leave the oil in the soil! Leave the coal in the hole! Leave the gas under the grass!” That was message of protesters at the 2017 G20 meeting. But from the facts shown in this chapter, we can see that on the whole, fossil fuels are not being left in the ground, where they have to remain if an ecological disaster is to be avoided. On the contrary, the extraction of coal, oil and gas continues almost as though the climate emergency did not exist. Most politicians, with their eyes focused on the present, seem blind to future dangers. They think primarily about the jobs and living standards of their constituents, and about the next election. Meanwhile, the future of human civilization is neglected and remains in peril.¹⁴

The fact that historically, the highly industrialized nations were primarily responsible for atmospheric CO₂ increases does not excuse the developing countries from their responsibility for saving the future. Today China’s coal, India’s coal, Venezuela’s tar sands and Brazil’s pre-salt oil are among the greatest threats, and in these countries as elsewhere, extraction must stop.

We have to wake up! Business as usual cannot continue!

13.13 Permian-Triassic extinction event

The geological record shows five major extinction events.

- Ordovician-Silurian Extinction. around 439 million years ago.
- Late Devonian Extinction. 375-360 million years ago.
- Permian-Triassic extinction. 352 million years ago.
- Triassic-Jurassic extinction, 201 million years ago.
- Cretaceous-Paleogene extinction, 66 million years ago.

¹⁴See <https://www.theguardian.com/commentisfree/2017/sep/18/enough-tiptoeing-around-lets-make-this-clear-coal-kills-people>

The most devastating of these was the Permian-Triassic extinction, which occurred 252 million years ago.¹⁵ In the Permian-Triassic extinction, 96% of all marine species and 76% of all terrestrial vertebrates disappeared forever. The cause of this extremely severe event is disputed, but according to one of the most plausible theories it was triggered by a massive volcanic eruption in Siberia, which released enormous amounts of CO₂ into the earth's atmosphere.

The region where massive volcanic eruptions are known to have occurred 252 million years ago called the "Siberian Traps". (The "Traps" part of the name comes from the fact that many of the volcanic rock formations in the region resemble staircases. The Swedish word for staircase is "trapped".) The eruptions continued for about a million years.

Today the area covered is about 2 million square kilometers, roughly equal to western Europe in land area. Estimates of the original coverage are as high as 7 million square kilometers. The original volume of lava is estimated to range from 1 to 4 million cubic kilometers.

The CO₂ released by the Siberian Traps eruption is believed to have caused a global temperature increase of 6°C, and this was enough to trigger the methane-hydrate feedback loop, which will be discussed below. The earth's temperature is thought to have continued to rise for 85,000 years, finally reaching 15° above normal.

13.14 Tipping points and feedback loops

A tipping point is usually defined as the threshold for an abrupt and irreversible change¹⁶. To illustrate this idea, we can think of a book lying on a table. If we gradually push the book towards the edge of the table, we will finally reach a point after which more than half of the weight of the book will not be supported by the table. When this "tipping point" is passed the situation will suddenly become unstable, and the book will fall to the floor. Analogously, as the earth's climate gradually changes, we may reach tipping points. If we pass these points, sudden instabilities and abrupt climatic changes will occur.

Greenland ice cores supply a record of temperatures in the past, and through geological evidence we have evidence of sea levels in past epochs. These historical records show that abrupt climatic changes have occurred in the past.

Timothy Michael Lenton, FRS, Professor of Climate Change and Earth System Science at the University of Exeter, lists the following examples of climatic tipping points:

- Boreal forest dieback

¹⁵ <https://www.thomhartmann.com/bigpicture/last-hours-climate-change>
The Last Hours of Humanity: Warming the World To Extinction (book), by Thom Hartmann
<https://www.amazon.com/Last-Hours-Humanity-Warming-Extinction/dp/1629213640>
<http://www.mediaite.com/online/leonardo-dicaprio-boosts-thom-hartmann-apocalyptic-global-warming-film-last-hours/>

¹⁶Other definitions of tipping points are possible. A few authors define these as points beyond which change is inevitable, emphasizing that while inevitable, the change may be slow.

- Amazon rainforest dieback
- Loss of Arctic and Antarctic sea ice (Polar ice packs) and melting of Greenland and Antarctic ice sheets
- Disruption to Indian and West African monsoon
- Formation of Atlantic deep water near the Arctic ocean, which is a component process of the thermohaline circulation.
- Loss of permafrost, leading to potential Arctic methane release and clathrate gun effect

It can be seen from this list that climate tipping points are associated with feedback loops. For example, the boreal forest dieback and the Amazon rainforest dieback tipping points are associated with the feedback loop involving the drying of forests and forest fires, while the tipping point involving loss of Arctic and Antarctic sea ice is associated with the Albedo effect feedback loop. The tipping point involving loss of permafrost is associated with the methane hydrate feedback loop.

Once a positive feedback loop starts to operate in earnest, change may be abrupt.

13.15 Greta Thunberg's TED talk

While political leaders and the older generation have been slow to react to the climate crisis, young people, whose future is at stake, are wide awake and are warning the world that action must be taken immediately if disaster is to be avoided. Massive global demonstrations have been initiated by the teenage activist, Greta Thunberg, who has succeeded where others have failed by speaking with extraordinary clarity, honesty and forcefulness.

Greta was born in Sweden in 2003. Her father, Svante Thunberg, is related to Svante Arrhenius, one of the important pioneers of climate science, and is named after him. Greta's mother was a successful opera singer. Greta Thunberg's strong belief in the urgency of action to prevent catastrophic climate change converted her parents, so that they made changes in their lives. For example, Greta's mother gave up her career as an opera singer because it involved air travel.

In November, 2018, Greta Thunberg gave an impressively clear TEDx talk in Stockholm, the video of which was recently released.¹⁷ Here is a transcript of the talk.

When I was about 8 years old, I first heard about something called 'climate change' or 'global warming'. Apparently, that was something humans had created by our way of living. I was told to turn off the lights to save energy and to recycle paper to save resources. I remember thinking that it was very

¹⁷<https://www.dailykos.com/stories/2018/12/16/1819508/-A-Call-to-Action-on-Climate-Change-by-15-year-Old-Greta-Thunberg>

strange that humans, who are an animal species among others, could be capable of changing the Earth's climate. Because, if we were, and if it was really happening, we wouldn't be talking about anything else. As soon as you turn on the TV, everything would be about that. Headlines, radio, newspapers: You would never read or hear about anything else. As if there was a world war going on, but no one ever talked about it. If burning fossil fuels was so bad that it threatened our very existence, how could we just continue like before? Why were there no restrictions? Why wasn't it made illegal?

To me, that did not add up. It was too unreal.

So, when I was 11, I became ill, I fell into depression, I stopped talking, and I stopped eating. In two months, I lost about 10 kilos of weight. Later on, I was diagnosed with Asperger's syndrome, OCD and selective mutism. This basically means, I only speak, when I think it is necessary.

Now is one of those moments.

For those of us, who are on the spectrum, almost everything is black or white. We aren't very good at lying and we usually don't enjoy participating in the social games that the rest of you seem so fond of. I think, in many ways, that we autistic are the normal ones and the rest of the people are pretty strange. Especially when it comes to the sustainability crisis: Where everyone keeps saying that climate change is an existential threat and the most important issue of all. And yet, they just carry on like before.

I don't understand that. Because if the emissions have to stop, then we must stop the emissions. To me, that is black or white. There are no gray areas when it comes to survival. Either we go on as a civilization or we don't.

We have to change.

Rich countries like Sweden need to start reducing emissions by at least 15% every year. And that is so that we can stay below a 2 degrees warming target. Yet, as the IPCC has recently demonstrated, aiming instead for 1.5 degrees Celsius would significantly reduce the climate impacts. But we can only imagine what that means for reducing emissions.

You would think the media and every one of our leaders would be talking about nothing else. But they never even mention it.

Nor does anyone ever mentioned the greenhouse gases already locked in the system. Nor that air pollution is hiding some warming; so that, when we stop burning fossil fuels, we already have an extra level of warming - perhaps as high as 0.5 to 1.1 degrees Celsius.

Furthermore, does hardly anyone speak about the fact that we are in the midst of the sixth mass extinction: With up to 200 species going extinct every single day. That the extinction rate is today between 1000 and 10,000 times higher than what is seen as normal.

Nor does hardly anyone ever speak about the aspect of equity or climate justice, clearly stated everywhere in the Paris agreement, which is absolutely necessary to make it work on a global scale. That means that rich countries

need to get down to zero emissions within 6 to 12 years with today's emission speed. And that is so that people in poorer countries can have a chance to heighten their standard of living by building some of the infrastructures that we have already built, such as roads, schools, hospitals, clean drinking water, electricity, and so on. Because, how can we expect countries like India or Nigeria to care about the climate crisis if we, who already have everything, don't care even a second about it or our actual commitments to the Paris agreement?

So why are we not reducing our emissions? Why are they in fact still increasing? Are we knowingly causing a mass extinction? Are we evil?

No, of course, not. People keep doing what they do because the vast majority doesn't have a clue about the actual consequences for their everyday life. And they don't know that rapid change is required.

We all think we know and we all think everybody knows. But we don't.

Because, how could we? If there really was a crisis, and if this crisis was caused by our emissions, you would at least see some signs. Not just flooded cities. Tens of thousands of dead people and whole nations leveled to piles of torn down buildings. You would see some restrictions.

But no. And no one talks about it. There are no emergency meetings, no headlines, no breaking news. No one is acting as if we were in a crisis.

Even most climate scientists or green politicians keep on flying around the world, eating meat and dairy.

If I live to be 100, I will be alive in the year 2103. When you think about the future today, you don't think beyond the year 2050. By then I will, in the best case, not even have lived half of my life. What happens next? In the year 2078, I will celebrate my 75th birthday. If I have children or grandchildren, maybe they will spend that day with me. Maybe they will ask me about you, the people who were around back in 2018. Maybe they will ask why you didn't do anything while there still was time to act. What we do or don't do right now, will affect my entire life and the lives of my children and grandchildren. What we do or don't do right now, me and my generation can't undo in the future.

So, when school started in August of this year, I decided that this was enough. I set myself down on the ground outside the Swedish parliament. I school-striking for the climate.

Some people say that I should be in school instead. Some people say that I should study, to become a climate scientist so that I can solve the climate crisis.

But the climate crisis has already been solved. We already have all the facts and solutions. All we have to do is to wake up and change.

And why should I be studying for a future that soon will be no more, when no one is doing anything whatsoever to save that future? And what is the point of learning facts in the school system, when the most important facts

given by the finest science of that same school system clearly means nothing to our politicians and our society?

Some people say that Sweden is just a small country and that it doesn't matter what we do. But I think that if a few children can get headlines all over the world just by not coming to school for a few weeks, imagine what we could all do together if we wanted to?

Now we're almost at the end of my talk and this is where people usually people usually start talking about hope. Solar panels, wind power, circular economy, and so on. But I'm not going to do that. We've had 30 years of pep talking and selling positive ideas. And I'm sorry but it doesn't work because if it would have, the emissions would have gone down by now. They haven't.

And yes, we do need hope. Of course, we do. But the one thing we need more than hope is action. Once we start to act, hope is everywhere. So instead of looking for hope, look for action. Then and only then, hope will come today.

Today we use 100 million barrels of oil every single day. There are no politics to change that. There are no rules to keep that oil in the ground. So, we can't save the world by playing by the rules, because the rules have to be changed.

Everything needs to change and it has to start today.

Thank you.

13.16 Only immediate climate action can save the future

Immediate action to halt the extraction of fossil fuels and greatly reduce the emission of CO₂ and other greenhouse gasses is needed to save the long-term future of human civilization and the biosphere.

At the opening ceremony of United Nations-sponsored climate talks in Katowice, Poland, Sir David Attenborough said "Right now, we are facing a man-made disaster of global scale. Our greatest threat in thousands of years. Climate change. If we don't take action, the collapse of our civilizations and the extinction of much of the natural world is on the horizon. The world's people have spoken. Their message is clear. Time is running out. They want you, the decision-makers, to act now."

Antonio Guterres, UN Secretary-General, said climate change was already "a matter of life and death" for many countries. He added that the world is "nowhere near where it needs to be" on the transition to a low-carbon economy.

Swedish student Greta Thunberg, is a 16-year-old who has launched a climate protest movement in her country. She said, in a short but very clear speech after that of UN leader Antonio Guterres: "Some people say that I should be in school instead. Some people say that I should study to become a climate scientist so that I can 'solve the climate crisis'. But the climate crisis has already been solved. We already have all the facts and solutions."

She added: “Why should I be studying for a future that soon may be no more, when no one is doing anything to save that future? And what is the point of learning facts when the most important facts clearly mean nothing to our society?”

Thunberg continued: “Today we use 100 million barrels of oil every single day. There are no politics to change that. There are no rules to keep that oil in the ground. So we can’t save the world by playing by the rules. Because the rules have to be changed.”

She concluded by saying that “since our leaders are behaving like children, we will have to take the responsibility they should have taken long ago.”

Appearing among billionaires, corporate CEO’s and heads of state at the Davos Economic Forum in Switzerland, like a new Joan of Arc, 16-year-old Swedish climate activist Greta Thunberg called on decision-makers to fulfil their responsibilities towards future generations. Here are some excerpts from her speech:

Greta’s speech at Davos

Our house is on fire. I am here to say, our house is on fire. According to the IPCC, we are less than 12 years away from not being able to undo our mistakes. In that time, unprecedented changes in all aspects of society need to have taken place, including a reduction of our CO₂ emissions by at least 50%...

Here in Davos - just like everywhere else - everyone is talking about money. It seems money and growth are our only main concerns.

And since the climate crisis has never once been treated as a crisis, people are simply not aware of the full consequences on our everyday life. People are not aware that there is such a thing as a carbon budget, and just how incredibly small that remaining carbon budget is. That needs to change today.

No other current challenge can match the importance of establishing a wide, public awareness and understanding of our rapidly disappearing carbon budget, that should and must become our new global currency and the very heart of our future and present economics.

We are at a time in history where everyone with any insight of the climate crisis that threatens our civilization - and the entire biosphere - must speak out in clear language, no matter how uncomfortable and unprofitable that may be.

We must change almost everything in our current societies. The bigger your carbon footprint, the bigger your moral duty. The bigger your platform, the bigger your responsibility.

13.17 Worldwide school strike, 15 March, 2019

Over 1.4 million young students across all continents took to the streets on Friday March 15th for the first ever global climate strike. Messages in more than 40 languages were loud and clear: world leaders must act now to address the climate crisis and save our future. The school strike was the largest climate action in history. Nevertheless it went almost unmentioned in the media,

Here are some of the statements by the students explaining why they took part in the strikes:

In India, no one talks about climate change. You don't see it on the news or in the papers or hear about it from government. We want global leaders to declare a climate emergency. If we don't act today, then we will have no tomorrow. - Vidit Baya, 17, Udaipur, India.

We face heartbreaking loss due to increasingly extreme weather events. We urge the Taiwanese government to implement mitigation measures and face up to the vulnerability of indigenous people, halt construction projects in the indigenous traditional realm, and recognize the legal status of Plains Indigenous People, in order to implement environmental protection as a bottom-up approach - Kaisanan Ahuan, Puli City, Taiwan.

We have reached a point in history when we have the technical capacities to solve poverty, malnutrition, inequality and of course global warming. The deciding factors for whether we take advantage of our potential will be our activism, our international unity and our ability to develop the art of making the impossible possible. Whether we succeed or not depends on our political will - Eyal Weintraub, 18, and Bruno Rodriguez, 18, Argentina.

The damage done by multinationals is enormous: the lack of transparency, dubious contracts, the weakening of the soil, the destruction of flora and fauna, the lack of respect for mining codes, the contamination of groundwater. In Mali, the state exercises insufficient control over the practices of the multinationals, and it is us, the citizens, who suffer the consequences. The climate alarm has sounded, and the time has come for us all to realize that there is still time to act locally, in our homes, our villages, our cities - Mone Fousseny, 22, Mali.

13.18 Understatement of existential climate risk

Here are some excerpts from a 44-page report entitled *What Lies Beneath: The Understanding of Existential Climate Risk*, by David Spratt and Ian Dunlop¹⁸:

Three decades ago, when serious debate on human-induced climate change began at the global level, a great deal of statesmanship was on display. There was a preparedness to recognize that this was an issue transcending nation states, ideologies and political parties which had to be addressed pro-actively in the long-term interests of humanity as a whole. This was the case even though the existential nature of the risk it posed was far less clear cut than it is today.

As global institutions, such as the United Nations Framework Convention on Climate Change (UNFCCC) which was established at the Rio Earth Summit in 1992, were developed to take up this challenge, and the extent of change this would demand of the fossil-fuel-dominated world order became clearer, the forces of resistance began to mobilize. Today, as a consequence, and despite the diplomatic triumph of the 2015 Paris Agreement, the debate around climate change policy has never been more dysfunctional, indeed Orwellian.

In his book 1984, George Orwell describes a double-think totalitarian state where most of the population accepts “the most flagrant violations of reality, because they never fully grasped the enormity of what was demanded of them, and were not sufficiently interested in public events to notice what was happening. By lack of understanding they remained sane.”

Orwell could have been writing about climate change and policymaking. International agreements talk of limiting global warming to 1.5-2 degrees Celsius (°C), but in reality they set the world on a path of 3-5°C of warming. Goals are reaffirmed, only to be abandoned. Coal is “clean”. Just 1°C of warming is already dangerous, but this cannot be admitted. The planetary future is hostage to myopic national self-interest. Action is delayed on the assumption that as yet unproven technologies will save the day, decades hence. The risks are existential, but it is “alarmist” to say so.

A one-in-two or one-in-three chance of missing a goal is normalized as reasonable. Moral hazard permeates official thinking, in that there is an incentive to ignore the risks in the interests of political expediency.

Climate policymaking for years has been cognitively dissonant, “a flagrant violation of reality”. So it is unsurprising that there is a lack of understanding amongst the public and elites of the full measure of the climate challenge. Yet most Australians sense where we are heading: three-quarters of Australians see climate change as catastrophic risk, and half see our way of life ending within the next 100 years.

¹⁸<https://www.breakthroughonline.org.au/>

Politics and policymaking have norms: rules and practices, assumptions and boundaries, that constrain and shape them. In recent years, the previous norms of statesmanship and long-term thinking have disappeared, replaced by an obsession with short-term political and commercial advantage. Climate policymaking is no exception. Since 1992, short-term economic interest has trumped environmental and future human needs.

The world today emits 50% more carbon dioxide (CO₂) from the consumption of energy than it did 25 years ago, and the global economy has more than doubled in size. The UNFCCC strives “to enable economic development to proceed in a sustainable manner”, but every year humanity’s ecological footprint becomes larger and less sustainable. Humanity now requires the biophysical capacity of 1.7 Earths annually as it rapidly chews up natural capital.

A fast, emergency-scale transition to a post-fossil fuel world is absolutely necessary to address climate change. But this is excluded from consideration by policymakers because it is considered to be too disruptive. The orthodoxy is that there is time for an orderly economic transition within the current short-termist political paradigm. Discussion of what would be safe - less warming than we presently experience - is non-existent. And so we have a policy failure of epic proportions.

Policymakers, in their magical thinking, imagine a mitigation path of gradual change to be constructed over many decades in a growing, prosperous world. The world not imagined is the one that now exists: of looming financial instability; of a global crisis of political legitimacy and “fake news”; of a sustainability crisis that extends far beyond climate change to include all the fundamentals of human existence and most significant planetary boundaries (soils, potable water, oceans, the atmosphere, biodiversity, and so on); and of severe global energy-sector dislocation.

In anticipation of the upheaval that climate change would impose upon the global order, the IPCC was established by the United Nations (UN) in 1988, charged with regularly assessing the global consensus on climate science as a basis for policymaking. The IPCC Assessment Reports (AR), produced every five-to-eight years, play a large part in the public framing of the climate narrative: new reports are a global media event.

AR5 was produced in 2013-14, with AR6 due in 2022. The IPCC has done critical, indispensable work of the highest standard in pulling together a periodic consensus of what must be the most exhaustive scientific investigation in world history.

It does not carry out its own research, but reviews and collates peer-reviewed material from across the spectrum of this incredibly complex area, identifying key issues and trends for policymaker consideration. However, the IPCC process suffers from all the dangers of consensus-building in such a wide-ranging and complex arena. For example, IPCC reports, of necessity, do not always contain the latest available information. Consensus-building can lead to

“least drama”, lowest-common-denominator outcomes, which overlook critical issues. This is particularly the case with the “fat-tails” of probability distributions, that is, the high-impact but lower-probability events where scientific knowledge is more limited.

Vested-interest pressure is acute in all directions; climate denialists accuse the IPCC of alarmism, whereas many climate action proponents consider the IPCC to be far too conservative. To cap it all, the IPCC conclusions are subject to intense political oversight before being released, which historically has had the effect of substantially watering-down sound scientific findings.

These limitations are understandable, and arguably were not of overriding importance in the early period of the IPCC. However, as time has progressed, it is now clear that the risks posed by climate change are far greater than previously anticipated. We have moved out of the twilight period of much talk, but relatively limited climate impacts, into the harsh light of physically-evident existential threats. Climate change is now turning nasty, as we have witnessed recently in the North America, East and South Asia, the Middle East and Europe, with record-breaking heatwaves and wildfires, more intense flooding and more damaging hurricanes.

The distinction between climate science and risk is the critical issue, for the two are not the same. Scientific reticence - a reluctance to spell out the full risk implications of climate science in the absence of perfect information - has become a major problem. Whilst this is understandable, particularly when scientists are continually criticized by denialists and political apparatchiks for speaking out, it is extremely dangerous given the fat-tail risks of climate change. Waiting for perfect information, as we are continually urged to do by political and economic elites, means it will be too late to act. Time is not on our side. Sensible risk management addresses risk in time to prevent it happening, and that time is now.

Irreversible, adverse climate change on the global scale now occurring is an existential risk to human civilization. Many of the world’s top climate scientists - Kevin Anderson, James Hansen, Michael E. Mann, Michael Oppenheimer, Naomi Oreskes, Stefan Rahmstorf, Eric Rignot, Hans Joachim Schellnhuber, Kevin Trenberth and others - who are quoted in this report well understand these implications and are forthright about their findings, where we are heading, and the limitations of IPCC reports.

This report seeks to alert the wider community and business and political leaders to these limitations and urges changes to the IPCC approach, to the wider UNFCCC negotiations, and to national policymaking. It is clear that existing processes will not deliver the transformation to a carbon-negative world in the limited time now available. We urgently require a re-framing of scientific research within an existential risk-management framework. This requires special precautions that go well beyond conventional risk management. Like an iceberg, there is great danger in “what lies beneath”.

Existential Risk to Human Civilization

In 2016, the World Economic Forum survey of the most impactful risks for the years ahead elevated the failure of climate change mitigation and adaptation to the top of the list, ahead of weapons of mass destruction, ranking second, and water crises, ranking third. By 2018, following a year characterized by high-impact hurricanes and extreme temperatures, extreme-weather events were seen as the single most prominent risk. As the survey noted: “We have been pushing our planet to the brink and the damage is becoming increasingly clear.”

Climate change is an existential risk to human civilization: that is, an adverse outcome that would either annihilate intelligent life or permanently and drastically curtail its potential.

Temperature rises that are now in prospect, after the Paris Agreement, are in the range of 3-5 °C. At present, the Paris Agreement voluntary emission reduction commitments, if implemented, would result in planetary warming of 3.4 °C by 2100, without taking into account “long-term” carbon-cycle feedbacks. With a higher climate sensitivity figure of 4.5 °C, for example, which would account for such feedbacks, the Paris path would result in around 5 °C of warming, according to a MIT study.

A study by Schroeder Investment Management published in June 2017 found - after taking into account indicators across a wide range of the political, financial, energy and regulatory sectors - the average temperature increase implied for the Paris Agreement across all sectors was 4.1 °C.

Yet 3 °C of warming already constitutes an existential risk. A 2007 study by two US national security think-tanks concluded that 3 °C of warming and a 0.5 meter sea-level rise would likely lead to “outright chaos” and “nuclear war is possible”, emphasizing how “massive non-linear events in the global environment give rise to massive nonlinear societal event”.

The Global Challenges Foundation (GCF) explains what could happen: “If climate change was to reach 3 °C, most of Bangladesh and Florida would drown, while major coastal cities - Shanghai, Lagos, Mumbai - would be swamped, likely creating large flows of climate refugees. Most regions in the world would see a significant drop in food production and increasing numbers of extreme weather events, whether heat waves, floods or storms. This likely scenario for a 3 °C rise does not take into account the considerable risk that self-reinforcing feedback loops set in when a certain threshold is reached, leading to an ever increasing rise in temperature. Potential thresholds include the melting of the Arctic permafrost releasing methane into the atmosphere, forest die-back releasing the carbon currently stored in the Amazon and boreal forests, or the melting of polar ice caps that would no longer reflect away light and heat from the sun.”

Warming of 4 °C or more could reduce the global human population by 80% or 90%, and the World Bank reports “there is no certainty that adaptation to

a 4 °C world is possible.”

Prof. Kevin Anderson says a 4 °C future “is incompatible with an organized global community, is likely to be beyond ‘adaptation’, is devastating to the majority of ecosystems, and has a high probability of not being stable”.

This is a commonly-held sentiment amongst climate scientists. A recent study by the European Commission’s Joint Research Centre found that if the global temperature rose 4 °C, then extreme heatwaves with “apparent temperatures” peaking at over 55 °C will begin to regularly affect many densely populated parts of the world, forcing much activity in the modern industrial world to stop. (“Apparent temperatures” refers to the Heat Index, which quantifies the combined effect of heat and humidity to provide people with a means of avoiding dangerous conditions.)

In 2017, one of the first research papers to focus explicitly on existential climate risks proposed that “mitigation goals be set in terms of climate risk category instead of a temperature threshold”, and established a “dangerous” risk category of warming greater than 1.5 °C, and a “catastrophic” category for warming of 3 °C or more. The authors focussed on the impacts on the world’s poorest three billion people, on health and heat stress, and the impacts of climate extremes on such people with limited adaptation resources. They found that a 2 °C warming “would double the land area subject to deadly heat and expose 48% of the population (to deadly heat). A 4 °C warming by 2100 would subject 47% of the land area and almost 74% of the world population to deadly heat, which could pose existential risks to humans and mammals alike unless massive adaptation measures are implemented.”

A 2017 survey of global catastrophic risks by the Global Challenges Foundation found that: “In high-end [climate] scenarios, the scale of destruction is beyond our capacity to model, with a high likelihood of human civilization coming to an end.”

84% of 8000 people in eight countries surveyed for the Foundation considered climate change a “global catastrophic risk”.

Existential risk may arise from a fast rate of system change, since the capacity to adapt, in both the natural and human worlds, is inversely proportional to the pace of change, amongst other factors. In 2004, researchers reported on the rate of warming as a driver of extinction...

At 4 °C of warming “the limits for adaptation for natural systems would largely be exceeded throughout the world”.

Ecological breakdown of this scale would ensure an existential human crisis. By slow degrees, these existential risks are being recognized. In May 2018, an inquiry by the Australian Senate into national security and global warming recognized “climate change as a current and existential national security risk... defined as ‘one that threatens the premature extinction of Earth-originating intelligent life or the permanent and drastic destruction of its potential for desirable future development’”.

In April 2018, the Intelligence on European Pensions and Institutional Investment think-tank warned business leaders that “climate change is an existential risk whose elimination must become a corporate objective”.

However the most recent IPCC Assessment Report did not consider the issue. Whilst the term “risk management” appears in the 2014 IPCC Synthesis Report fourteen times, the terms “existential” and “catastrophic” do not appear...

13.19 The 2018 IPCC report

Excerpts from an article summarizing the report

Here are excerpts from an article entitled **UN Experts Warn of 'Climate Catastrophe' by 2040** by Jesica Corbett. The article was published in *Common Dreams* on Monday, October 8, 2018.¹⁹:

“The climate crisis is here and already impacting the most vulnerable,” notes 350.org’s program director. “Staying under 1.5°C is now a matter of political will.”

Underscoring the need for “rapid, far-reaching, and unprecedented” changes to life as we know it to combat the global climate crisis, a new report from the Intergovernmental Panel on Climate Change (IPCC) - the United Nations’ leading body for climate science - details what the world could look like if the global temperature rises to 1.5°C versus 2°C (2.7°F versus 3.6°F) above pre-industrial levels, and outlines pathways to reducing greenhouse gas emissions in the context of sustainable development and efforts to eradicate poverty.

“Climate change represents an urgent and potentially irreversible threat to human societies and the planet,” the report reads. “Human-induced warming has already reached about 1°C (1.8°F) above pre-industrial levels at the time of writing of this Special Report... If the current warming rate continues, the world would reach human-induced global warming of 1.5°C around 2040.”

Approved by the IPCC in South Korea on Saturday ahead of COP24 in Poland in December, *Global Warming of 1.5°C* was produced by 91 authors and reviewers from 40 countries. Its release has elicited calls to action from climate campaigners and policymakers the world over.

“This is a climate emergency. The IPCC 1.5 report starkly illustrates the difference between temperature rises of 1.5°C and 2°C - for many around the world this is a matter of life and death,” declared Karin Nansen, chair of Friends of the Earth International (FOEI). “It is crucial to keep temperature

¹⁹<https://www.commondreams.org/news/2018/10/08/un-experts-warn-climate-catastrophe-2040-without-rapid-and-unprecedented-global>

rise well below 1.5 degrees ... but the evidence presented by the IPCC shows that there is a narrow and shrinking window in which to do so.”

The report was requested when the international community came together in December of 2015 for the Paris agreement, which aims to keep global warming within this century “well below” 2°C, with an ultimate target of 1.5°C. President Donald Trump’s predecessor supported the accord, but Trump has vowed to withdraw the United States, even as every other nation on the planet has pledged their support for it. In many cases, however, sworn support hasn’t led to effective policy.

“It’s a fresh reminder, if one was needed, that current emissions reduction pledges are not enough to meet the long-term goals of the Paris agreement. Indeed, they are not enough for any appropriately ambitious temperature target, given what we know about dangerous climate impacts already unfolding even at lower temperature thresholds,” Rachel Cleetus, lead economist and climate policy manager for the Union of Concerned Scientists (UCS), wrote ahead of its release.

“The policy implications of the report are obvious: We need to implement a suite of policies to sharply limit carbon emissions and build climate resilience, and we must do all this in a way that prioritizes equitable outcomes particularly for the world’s poor and marginalized communities,” Cleetus added.

“We want a just transition to a clean energy system that benefits people not corporations,” Nansen emphasized. “Only with a radical transformation of our energy, food and economic systems, embracing environmental, social, gender and economic justice, can we prevent climate catastrophe and temperature rises exceeding 1.5°C.”

Only immediate climate action can save the future

Immediate action to halt the extraction of fossil fuels and greatly reduce the emission of CO₂ and other greenhouse gasses is needed to save the long-term future of human civilization and the biosphere.

At the opening ceremony of United Nations-sponsored climate talks in Katowice, Poland, Sir David Attenborough said “Right now, we are facing a man-made disaster of global scale. Our greatest threat in thousands of years. Climate change. If we don’t take action, the collapse of our civilizations and the extinction of much of the natural world is on the horizon. The world’s people have spoken. Their message is clear. Time is running out. They want you, the decision-makers, to act now.”

Antonio Guterres, UN Secretary-General, said climate change was already “a matter of life and death” for many countries. He added that the world is “nowhere near where it needs to be” on the transition to a low-carbon economy.

Swedish student Greta Thunberg, is a 16-year-old who has launched a climate protest movement in her country. She said, in a short but very clear speech after that of UN leader Antonio Guterres: “Some people say that I should be in school instead. Some people say

that I should study to become a climate scientist so that I can ‘solve the climate crisis’. But the climate crisis has already been solved. We already have all the facts and solutions.”

She added: “Why should I be studying for a future that soon may be no more, when no one is doing anything to save that future? And what is the point of learning facts when the most important facts clearly mean nothing to our society?”

Thunberg continued: “Today we use 100 million barrels of oil every single day. There are no politics to change that. There are no rules to keep that oil in the ground. So we can’t save the world by playing by the rules. Because the rules have to be changed.”

She concluded by saying that “since our leaders are behaving like children, we will have to take the responsibility they should have taken long ago.”

Institutional inertia

Our collective failure to respond adequately to the current crisis is very largely due to institutional inertia. Our financial system is deeply embedded and resistant to change. Our entire industrial infrastructure is based on fossil fuels; but if the future is to be saved, the use of fossil fuels must stop. International relations are still based based on the concept of absolutely sovereign nation states, even though this concept has become a dangerous anachronism in an era of instantaneous global communication and economic interdependence. Within nations, systems of law and education change very slowly, although present dangers demand rapid revolutions in outlook and lifestyle.

The failure of the recent climate conferences to produce strong final documents can be attributed to the fact that the nations attending the conferences felt themselves to be in competition with each other, when in fact they ought to have cooperated in response to a common danger. The heavy hand of the fossil fuel industry also made itself felt at the conferences.

Until the development of coal-driven steam engines in the 19th century humans lived more or less in harmony with their environment. Then, fossil fuels, representing many millions of years of stored sunlight, were extracted and burned in two centuries, driving a frenzy of growth of population and industry that has lasted until the present. But today, the party is over. Coal, oil and gas are nearly exhausted, and what remains of them must be left in the ground to avoid existential threats to humans and the biosphere. Big coal and oil corporations base the value of their stocks on ownership of the remaining resources that are still buried, and they can be counted on to use every trick, fair or unfair, to turn those resources into money.

In general corporations represent a strong force resisting change. By law, the directors of corporations are obliged to put the profits of stockholders above every other consideration. No room whatever is left for an ecological or social conscience. Increasingly, corporations have taken control of our mass media and our political system. They intervene in such a way as to make themselves richer, and thus to increase their control of the system.

Polite conversation and cultural inertia

Each day, the conventions of polite conversation contribute to our sense that everything is as it always was. Politeness requires that we do not talk about issues that might be contrary to another person's beliefs. Thus polite conversation is dominated by trivia, entertainment, sports, the weather, gossip, food, and so on. Worries about the distant future, the danger of nuclear war, the danger of uncontrollable climate change, or the danger of widespread famine seldom appear in conversations at the dinner table, over coffee or at the pub. In conversations between polite people, we obtain the false impression that all is well with the world. But in fact, all is not well. We have to act promptly and adequately to save the future.

The situation is exactly the same in the mass media. The programs and articles are dominated by trivia and entertainment. Serious discussions of the sudden crisis which civilization now faces are almost entirely absent, because the focus is on popularity and ratings. As Neil Postman remarked, we are entertaining ourselves to death.

Further growth implies future collapse

We have to face the fact that endless economic growth on a finite planet is a logical impossibility, and that we have reached or passed the sustainable limits to growth.

In today's world, we are pressing against the absolute limits of the earth's carrying capacity, and further growth carries with it the danger of future collapse. In the long run, neither the growth of industry nor that of population is sustainable; and we have now reached or exceeded the sustainable limits.

Our responsibility to future generations and to the biosphere

All of the technology needed for the replacement of fossil fuels by renewable energy is already in place. Although renewable sources currently supply only 19 percent of the world's energy requirements, they are growing rapidly. For example, wind energy is growing at the rate of 30 percent per year. Because of the remarkable properties of exponential growth, this will mean that wind will soon become a major supplier of the world's energy requirements, despite bitter opposition from the fossil fuel industry.

Both wind and solar energy can now compete economically with fossil fuels, and this situation will become even more pronounced if more countries put a tax on carbon emissions, as Finland, the Netherlands, Norway, Costa Rica, the United Kingdom and Ireland already have done.²⁰

Much research and thought have also been devoted to the concept of a steady-state economy. The only thing that is lacking is political will. It is up to the people of the world to make their collective will felt.²¹

²⁰<http://eruditio.worldacademy.org/issue-5/article/urgent-need-renewable-energy>

²¹<http://steadystate.org/category/herman-daly/>

History has given to our generation an enormous responsibility towards future generations. We must achieve a new kind of economy, a steady-state economy. We must stabilize global population. We must replace fossil fuels by renewable energy. We must abolish nuclear weapons. We must end the institution of war. We must reclaim democracy in our own countries when it has been lost. We must replace nationalism by a just system of international law. We must prevent degradation of the earth's environment. We must act with dedication and fearlessness to save the future of the earth for human civilization and for the plants and animals with which we share the gift of life.

“And yes, we do need hope. Of course, we do. But the one thing we need more than hope is action. Once we start to act, hope is everywhere. So instead of looking for hope, look for action. Then and only then, hope will come today.”
Greta Thunberg

Suggestions for further reading

1. A. Gore, *An Inconvenient Truth: The Planetary Emergency of Global Warming and What We Can Do About It*, Rodale Books, New York, (2006).
2. A. Gore, *Earth in the Balance: Forging a New Common Purpose*, Earthscan, (1992).
3. A.H. Ehrlich and P.R. Ehrlich, *Earth*, Thames and Methuen, (1987).
4. P.R. Ehrlich and A.H. Ehrlich, *The Population Explosion*, Simon and Schuster, (1990).
5. P.R. Ehrlich and A.H. Ehrlich, *Healing the Planet: Strategies for Resolving the Environmental Crisis*, Addison-Wesley, (1991).
6. P.R. Ehrlich and A.H. Ehrlich, *Betrayal of Science and Reason: How Anti-Environmental Rhetoric Threatens our Future*, Island Press, (1998).
7. P.R. Ehrlich and A.H. Ehrlich, *One With Nineveh: Politics, Consumption and the Human Future*, Island Press, (2004).
8. D.H. Meadows, D.L. Meadows, J. Randers, and W.W. Behrens III, *The Limits to Growth: A Report for the Club of Rome's Project on the Predicament of Mankind*, Universe Books, New York, (1972).
9. D.H. Meadows et al., *Beyond the Limits. Confronting Global Collapse and Envisioning a Sustainable Future*, Chelsea Green Publishing, Post Mills, Vermont, (1992).
10. D.H. Meadows, J. Randers and D.L. Meadows, *Limits to Growth: the 30-Year Update*, Chelsea Green Publishing, White River Jct., VT 05001, (2004).
11. A. Peccei and D. Ikeda, *Before it is Too Late*, Kodansha International, Tokyo, (1984).
12. V.K. Smith, ed., *Scarcity and Growth Reconsidered*, Johns Hopkins University Press, Baltimore, (1979).
13. British Petroleum, *BP Statistical Review of World Energy*, (published yearly).
14. R. Costanza, ed., *Ecological Economics: The Science and Management of Sustainability*, Colombia University Press, New York, (1991).
15. J. Darmstadter, *A Global Energy Perspective*, Sustainable Development Issue Backgrounder, Resources for the Future, (2002).

16. D.C. Hall and J.V. Hall, *Concepts and Measures of Natural Resource Scarcity*, *Journal of Environmental Economics and Management*, **11**, 363-379, (1984).
17. M.K. Hubbert, *Energy Resources*, in *Resources and Man: A Study and Recommendations*, Committee on Resources and Man, National Academy of Sciences, National Research Council, W.H. Freeman, San Francisco, (1969).
18. Intergovernmental Panel on Climate Change, *Climate Change 2001: The Scientific Basis*, IPCC, (2001).
19. J.A. Krautkraemer, *Nonrenewable Resource Scarcity*, *Journal of Economic Literature*, **36**, 2065-2107, (1998).
20. N. Stern et al., *The Stern Review*, www.sternreview.org.uk, (2006).
21. T.M. Swanson, ed., *The Economics and Ecology of Biodiversity Decline: The Forces Driving Global Change*, Cambridge University Press, (1995).
22. P.M. Vitousek, H.A. Mooney, J. Lubchenco and J.M. Melillo, *Human Domination of Earth's Ecosystems*, *Science*, **277**, 494-499, (1997).
23. World Resources Institute, *World Resources 200-2001: People and Ecosystems: The Fraying Web of Life*, WRI, Washington D.C., (2000).
24. A. Sampson, *The Seven Sisters: The Great Oil Companies of the World and How They Were Made*, Hodder and Staughton, London, (1988).
25. D. Yergin, *The Prize*, Simon and Schuster, New York, (1991).
26. M.B. Stoff, *Oil, War and American Security: The Search for a National Policy on Oil, 1941-1947*, Yale University Press, New Haven, (1980).
27. J. Stork, *Middle East Oil and the Energy Crisis*, *Monthly Review*, New York, (1976).
28. F. Benn, *Oil Diplomacy in the Twentieth Century*, St. Martin's Press, New York, (1986).
29. K. Roosevelt, *Countercoup: The Struggle for the Control of Iran*, McGraw-Hill, New York, (1979).
30. E. Abrahamian, *Iran Between Two Revolutions*, Princeton University Press, Princeton, (1982).
31. J.M. Blair, *The Control of Oil*, Random House, New York, (1976).
32. M.T. Klare, *Resource Wars: The New Landscape of Global Conflict*, Owl Books reprint edition, New York, (2002).
33. H. Mejcher, *Imperial Quest for Oil: Iraq, 1910-1928*, Ithaca Books, London, (1976).
34. P. Sluglett, *Britain in Iraq, 1914-1932*, Ithaca Press, London, (1976).
35. D.E. Omissi, *British Air Power and Colonial Control in Iraq, 1920-1925*, Manchester University Press, Manchester, (1990).
36. V.G. Kiernan, *Colonial Empires and Armies, 1815-1960*, Sutton, Stroud, (1998).
37. R. Solh, *Britain's 2 Wars With Iraq*, Ithaca Press, Reading, (1996).
38. D. Morgan and D.B. Ottaway, *In Iraqi War Scenario, Oil is Key Issue as U.S. Drillers Eye Huge petroleum Pool*, *Washington Post*, September 15, (2002).
39. C.J. Cleveland, *Physical and Economic Aspects of Natural Resource Scarcity: The Cost of Oil Supply in the Lower 48 United States 1936-1987*, *Resources and Energy* **13**, 163-188, (1991).

40. C.J. Cleveland, *Yield Per Effort for Additions to Crude Oil Reserves in the Lower 48 States, 1946-1989*, American Association of Petroleum Geologists Bulletin, **76**, 948-958, (1992).
41. M.K. Hubbert, *Technique of Prediction as Applied to the Production of Oil and Gas*, in *NBS Special Publication 631*, US Department of Commerce, National Bureau of Standards, (1982).
42. L.F. Ivanhoe, *Oil Discovery Indices and Projected Discoveries*, Oil and Gas Journal, **11**, 19, (1984).
43. L.F. Ivanhoe, *Future Crude Oil Supplies and Prices*, Oil and Gas Journal, July 25, 111-112, (1988).
44. L.F. Ivanhoe, *Updated Hubbert Curves Analyze World Oil Supply*, World Oil, November, 91-94, (1996).
45. L.F. Ivanhoe, *Get Ready for Another Oil Shock!*, The Futurist, January-February, 20-23, (1997).
46. Energy Information Administration, *International Energy Outlook, 2001*, US Department of Energy, (2001).
47. Energy Information Administration, *Caspian Sea Region*, US Department of Energy, (2001).
48. National Energy Policy Development Group, *National Energy Policy*, The White House, (<http://www.whitehouse.gov/energy/>), (2004).
49. M. Klare, *Bush-Cheney Energy Strategy: Procuring the Rest of the World's Oil*, Foreign Policy in Focus, (Interhemispheric Resource Center/Institute for Policy Studies/SEEN), Washington DC and Silver City NM, January, (2004).
50. IEA, *CO2 from Fuel Combustion Fact-Sheet*, International Energy Agency, (2005).
51. H. Youguo, *China's Coal Demand Outlook for 2020 and Analysis of Coal Supply Capacity*, International Energy Agency, (2003).
52. R.H. Williams, *Advanced Energy Supply Technologies*, in **World Energy Assessment: Energy and the Challenge of Sustainability**, UNDP, (2000).
53. H. Lehmann, *Energy Rich Japan*, Institute for Sustainable Solutions and Innovations, Aachen, (2003).
54. D. King, *Climate Change Science: Adapt, Mitigate or Ignore*, Science, **303** (5655), pp. 176-177, (2004).
55. S. Connor, *Global Warming Past Point of No Return*, The Independent, (116 September, 2005).
56. D. Rind, *Drying Out the Tropics*, New Scientist (6 May, 1995).
57. J. Patz et al., *Impact of Regional Climate Change on Human Health*, Nature, (17 November, 2005).
58. M. McCarthy, *China Crisis: Threat to the Global Environment*, The Independent, (19 October, 2005).
59. L.R. Brown, *The Twenty-Ninth Day*, W.W. Norton, New York, (1978).
60. W.V. Chandler, *Materials Recycling: The Virtue of Necessity*, Worldwatch Paper 56, Worldwatch Institute, Washington D.C, (1983).

61. W.C. Clark and others, *Managing Planet Earth*, Special Issue, *Scientific American*, September, (1989).
62. B. Commoner, *The Closing Circle: Nature, Man and Technology*, Bantam Books, New York, (1972).
63. C. Flavin, *Slowing Global Warming: A Worldwide Strategy*, Worldwatch Paper 91, Worldwatch Institute, Washington D.C., (1989).
64. J.R. Frisch, *Energy 2000-2020: World Prospects and Regional Stresses*, World Energy Conference, Graham and Trotman, (1983).
65. J. Gever, R. Kaufmann, D. Skole and C. Vorosmarty, *Beyond Oil: The Threat to Food and Fuel in the Coming Decades*, Ballinger, Cambridge MA, (1986).
66. J. Holdren and P. Herrera, *Energy*, Sierra Club Books, New York, (1971).
67. N. Myers, *The Sinking Ark*, Pergamon, New York, (1972).
68. National Academy of Sciences, *Energy and Climate*, NAS, Washington D.C., (1977).
69. W. Ophuls, *Ecology and the Politics of Scarcity*, W.H. Freeman, San Francisco, (1977).
70. A. Peccei, *The Human Quality*, Pergamon Press, Oxford, (1977).
71. A. Peccei, *One Hundred Pages for the Future*, Pergamon Press, New York, (1977).
72. E. Pestel, *Beyond the Limits to Growth*, Universe Books, New York, (1989).
73. C. Pollock, *Mining Urban Wastes: The Potential for Recycling*, Worldwatch Paper 76, Worldwatch Institute, Washington D.C., (1987).
74. S.H. Schneider, *The Genesis Strategy: Climate and Global Survival*, Plenum Press, (1976).
75. P.B. Smith, J.D. Schilling and A.P. Haines, *Introduction and Summary*, in *Draft Report of the Pugwash Study Group: The World at the Crossroads*, Berlin, (1992).
76. World Resources Institute, *World Resources*, Oxford University Press, New York, (published annually).
77. J.E. Young, John E., *Mining the Earth*, Worldwatch Paper 109, Worldwatch Institute, Washington D.C., (1992).
78. J.R. Craig, D.J. Vaughan and B.J. Skinner, *Resources of the Earth: Origin, Use and Environmental Impact, Third Edition*, Prentice Hall, (2001).
79. W. Youngquist, *Geodesinies: The Inevitable Control of Earth Resources Over Nations and Individuals*, National Book Company, Portland Oregon, (1997).
80. M. Tanzer, *The Race for Resources. Continuing Struggles Over Minerals and Fuels*, Monthly Review Press, New York, (1980).
81. C.B. Reed, *Fuels, Minerals and Human Survival*, Ann Arbor Science Publishers Inc., Ann Arbor Michigan, (1975).
82. A.A. Bartlett, *Forgotten Fundamentals of the Energy Crisis*, American Journal of Physics, **46**, 876-888, (1978).
83. N. Gall, *We are Living Off Our Capital*, Forbes, September, (1986).
84. M. Anklin et al., *Climate instability during the last interglacial period recorded in the GRIP ice core*. Nature **364**, 15 July: 203-207, (1993).
85. O. J. Blanchard and S. Fischer, *Lectures on Macroeconomics*. Cambridge, Mass.: MIT Press. (1989).

86. Ehrlich P-R (1995) *The scale of the human enterprise and biodiversity loss*, in *Extinction Rates*, eds Lawton JH, May RM (Oxford Univ Press, Oxford, UK), pp 214-226.
87. Dirzo R, et al. (2014) *Defaunation in the Anthropocene*. *Science* **345**:401-406.
88. Young HS, McCauley DJ, Galletti M, Dirzo R (2016) *Patterns, causes, and consequences of Anthropocene defaunation*. *Annu Rev Ecol Evol Syst* **47**:433-458.
89. World Wide Fund for Nature (2016) *Living Planet Report 2016. Risk and resilience in a new era*. (WWF International, Gland, Switzerland), 2017.
90. Maxwell SL, Fuller RA, Brooks TM, Watson JEM (2016) *Biodiversity: The ravages of guns, nets and bulldozers*. *Nature* **536**:143-145.
91. Laliberte AS, Ripple WJ (2004) *Range contractions of North American carnivores and ungulates*. *BioScience* **54**:123-138.
92. Worm B, Tittensor DP (2011) *Range contraction in large pelagic predators*. *Proc Natl Acad Sci USA* **108**:11942-11947.
93. Ripple WJ, et al. (2014) *Status and ecological effects of the world's largest carnivores*. *Science* **343**:1241484.
94. Barnosky AD, et al. (2011) *Has the Earth's sixth mass extinction already arrived?* *Nature* **471**:51-57.
95. Ceballos G, Garcia A, Ehrlich PR (2010) *The sixth extinction crisis: Loss of animal populations and species*. *J. Cosmology* **8**:1821-1831.
96. Ceballos G, et al. (2015) *Accelerated modern human-induced species losses: Entering the sixth mass extinction*. *Sci Adv* **1**:e1400253.
97. Wake DB, Vredenburg VT (2008) *Colloquium paper: Are we in the midst of the sixth mass extinction? A view from the world of amphibians*. *Proc Natl Acad Sci USA* **105**:11466-11473.
98. McCallum ML (2015) *Vertebrate biodiversity losses point to a sixth mass extinction*. *Biol Conserv* **24**:2497-2519.
99. Pimm SL, et al. (2014) *The biodiversity of species and their rates of extinction, distribution, and protection*. *Science* **344**:1246752.
100. McCauley DJ, et al. (2015) *Marine defaunation: Animal loss in the global ocean*. *Science* **347**:1255641.
101. Collen B, Böhm M, Kemp R, Baillie J (2012) *Spineless: Status and Trends of the World's Invertebrates* (Zoological Society of London, London). Red List
102. Daily G (1997) *Nature's Services: Societal Dependence on Natural Ecosystems*. (Island Press, Covello, CA).
103. Naeem S, Duffy JE, Zavaleta E (2012) *The functions of biological diversity in an age of extinction*. *Science* **336**:1401-1406.
104. Estes JA, et al. (2011) *Trophic downgrading of planet Earth*. *Science* **333**:301-306.
105. Brosi BJ, Briggs HM (2013) *Single pollinator species losses reduce floral fidelity and plant reproductive function*. *Proc Natl Acad Sci USA* **110**:13044-13048.
106. Briggs JC (2014) *Global biodiversity gain is concurrent with decreasing population sizes*. *Biodiver J* **5**:447-452.
107. Hooper DU, et al. (2012) *A global synthesis reveals biRed List diversity loss as a major driver of ecosystem change*. *Nature* **486**:105-108. Red List

108. Ehrlich PR (2014) *The case against de-extinction: It's a fascinating but dumb idea*. Yale Environment 360 (Yale University, New Haven, CT). Available at bit.ly/1gAIuJF. Accessed JunStudiese 10, 2017.
109. Hobbs RJ, Mooney HA (1998) *Broadening the extinction debate: Population deletions and additions in California and Western Australia*. *Conserv Biol* **12**:271-283. Studies
110. Hughes JB, Daily GC, Ehrlich PR (1997) *Population diversity: Its extent and extinction*. *Science* 278:689-692.
111. Ceballos G, Ehrlich PR (2002) Mammal population losses and the extinction crisis. *Science* **296**:904-907.
112. Gaston KJ, Fuller RA (2008) *Commonness, population depletion and conservation biology*. *Trends Ecol Evol* **23**:14-19.
113. International Union of Conservation of Nature (2015) *The IUCN Red List of Threatened Species, Version 2015.2* (IUCN, 2015). Available at www.iucnredlist.org. Accessed February 10, 2016. Revised January 10, 2017.
114. Durant SM, et al. (2017) *The global decline of cheetah *Acinonyx jubatus* and what it means for conservation*. *Proc Natl Acad Sci USA* **114**:528-533.
115. Henschel P, et al. (2014) *The lion in West Africa is critically endangered*. *PLoS One* **9**:e83500.
116. Challender D, et al. (2016) *On scaling up pangolin conservation*. *Traffic Bulletin* **28**: 19-21.
117. Fennessy J, et al. (2016) *Multi-locus analyses reveal four giraffe species instead of one*. *Curr Biol* **26**:2543-2549.
118. Butchart S, Dunn E (2003) *Using the IUCN Red List criteria to assess species with declining populations*. *Conserv Biol* **17**:1200-1202.
119. Gaston K, Blackburn T (2008) *Pattern and Process in Macroecology* (Blackwell Publishing, Hoboken, NJ). Red List
120. Thomas JA (2016) *ECOLOGY. Butterfly communities under threat*. *Science* 353:216-218.
121. Régnier C, et al. (2015) *Mass extinction in poorly known taxa*. *Proc Natl Acad Sci USA* **112**:7761-7766.25.
122. Hughes JB, Daily GC, Ehrlich PR (1997) *Population diversity: Its extent and extinction*. *Science* **278**:689-692.
123. Ceballos G, Ehrlich PR (2002) *Mammal population losses and the extinction crisis*. *Science* **296**:904-907.
124. Cardinale BJ, et al. (2012) *Biodiversity loss and its impact on humanity*. *Nature* **486**: 59-67.
125. Hurlbert AH, Jetz W (2007) *Species richness, hotspots, and the scale dependence of range maps in ecology and conservation*. *Proc Natl Acad Sci USA* **104**:13384-13389.
126. Peterson AT, Navarro-Sigüenza AG, Gordillo A (2016) *Assumption- versus data-based approaches to summarizing species' ranges*. *Conserv Biol*, 10.1111/cobi.12801.
127. Martnez-Ramos M, Ortz-Rodrguez I, Pinero D, Dirzo R, Sarukhn J (2016) *Humans disrupt ecological processes within tropical rainforest reserves*. *Proc Natl Acad Sci USA* **113**:5323-5328.

128. Camargo-Sanabria AA, Mendoza E, Guevara R, Mart[~]Áñez-Ramos M, Dirzo R (2015) *Experimental defaunation of terrestrial mammalian herbivores alters tropical rain-forest understorey diversity*. Proc Biol Sci **282**:20142580.
129. Petipas RH, Brody AK (2014) *Termites and ungulates affect arbuscular mycorrhizal richness and infectivity in a semiarid savanna*. Botany **92**:233-240.
130. Wardle DA, et al. (2004) *Ecological linkages between aboveground and belowground biota*. Science **304**:1629-1633.
131. Ceballos G, Ehrlich AH, Ehrlich PR (2015) **The Annihilation of Nature: Human Extinction of Birds and Mammals**, (Johns Hopkins Univ Press, Baltimore).
132. Knoll AH (2015) *Life on a Young Planet: The First Three Billion Years of Evolution on Earth*, (Princeton Univ Press, Princeton, NJ).
133. Barnosky AD, et al. (2014) *Introducing the scientific consensus on maintaining humanity's life support systems in the 21st century: Information for policy makers*. The Anthropocene Review **1**:78-109.
134. Ceballos G, Ehrlich PR, Soberón J, Salazar I, Fay JP (2005) *Global mammal conservation: What must we manage?* Science **309**:603-607.
135. Brown IL, Ehrlich PR (1980) *Population biology of the checkerspot butterfly, Euphydryas chalcedona structure of the Jasper Ridge colony*. Oecologia **47**:239-251.
136. Environmental Systems Research Institute (2011) *Release 10. Documentation Manual*, (Environmental Systems Research Institute, Redlands, CA).
137. Balling, R. C. 1988. *The climate impact of Sonoran vegetation discontinuity*. Climate Change **13**: 99-109.
138. Balling, R. C. 1991. *Impact of desertification on regional and global warming*. Bulletin of the American Meteorological Society **72**: 232-234.
139. Barigozzi, C. (ed.). 1986. *The Origin and Domestication of Cultivated Plants*. Amsterdam: Elsevier.
140. Botkin, D. B. 1989. *Science and the global environment*. In: D. B. Botkin et al., *Global Change*. New York: Academic Press, pp. 1-14.
141. Bryson, R. 1972. *Climate modification by air pollution*. In: N. Polunin (ed.), *The Environmental Future*. London: Macmillan, pp. 133-174.
142. Dregne, H. E., M. Kassas, and B. Rozanov. 1991. *A new assessment of the world status of desertification*. Desertification Control Bulletin, **no. 20**: 6-18.
143. FAO (Food and Agriculture Organization). 1991. *Protection of land resources: Deforestation* UNCED Prepcomm., 2nd session, Doc. A/CONF. 15/PC/27.
144. Hare, F. K. and L. A. J. Ogallo. 1993. *Climate Variation, Drought and Desertification*. WMO-No. 653. Geneva: WMO.
145. Houghton, J. T., B. A. Callander, and S. K. Varney (eds.). 1992. *Climate Change 1992. The Supplementary Report to the IPCC Scientific Assessment*. (Cambridge: Cambridge University Press).
146. Hulme, M. and M. Kelly. 1993. *Exploring the links between desertification and climate change*. Environment **35(6)**: 5-11, 39-45.
147. Jackson, R. D. and S. B. Idso. 1975. *Surface albedo and desertification*. Science **189**: 1012-1013.

148. Matthews, E. 1983. *Global vegetation and land use: New high-resolution databases for climatic studies*. *Journal of Climate and Meteorology* **22**: 474-487.
149. Schlesinger, W. H., et al. 1990. *Biological feedback in global desertification*. *Science* **247**: 1043-1048.
150. Turner, B. L., et al. 1990. "Two types of global environmental changes: Definitional and special-scale issues in their human dimensions." *Global Environmental Change* 1: 14-22.
151. UNESCO. 1960. *Medicinal plants of arid zones*. *Arid Zone Research* 13.
152. Vavilov, N. I. 1949. *The Origin, Variation, Immunity and Breeding of Cultivated Plants*. Waltham, Mass.: Chronica Botanical

Chapter 14

THE BIRTH OF ETHICS

14.1 Ethics can overwrite tribalism!

After the invention of agriculture, roughly 10,000 years ago, humans began to live in progressively larger groups, which were sometimes multi-ethnic. In order to make towns, cities and finally nations function without excessive injustice and violence, both ethical and legal systems were needed. Today, in an era of global economic interdependence, instantaneous worldwide communication and all-destroying thermonuclear weapons, we urgently need new global ethical principles and a just and enforceable system of international laws.

The very long childhood of humans allows learned behavior to overwrite instinctive behavior. A newborn antelope is able to stand on its feet and follow the herd almost immediately after birth. By contrast, a newborn human is totally helpless. With cultural evolution, the period of dependence has become progressively longer. Today, advanced education often requires humans to remain dependent on parental or state support until they are in their middle 20's!

Humans are capable of tribalistic inter-group atrocities such as genocides and wars, but they also have a genius for cooperation. Cultural evolution implies inter-group exchange of ideas and techniques. It is a cooperative enterprise in which all humans participate. It is cultural evolution that has given our special dominance. But cultural evolution depends on overwriting destructive tribalism with the principles of law, ethics and politeness. The success of human cultural evolution demonstrates that this is possible. Ethics can overwrite tribalism!

What is law?

The principles of law, ethics, politeness and kindness function in slightly different ways, but all of these behavioral rules help human societies to function in a cohesive and trouble-free way. Law is the most coarse. The mesh is made finer by ethics, while the rules of politeness and kindness fill in the remaining gaps.



Figure 14.1: **Hammurabi's code**

Legal systems began at a time at a time when tribal life was being replaced by life in villages, towns and cities. One of the oldest legal documents that we know of is a code of laws enacted by the Babylonian king Hammurabi in about 1754 BC. It consists of 282 laws, with scaled punishments, governing household behavior, marriage, divorce, paternity, inheritance, payments for services, and so on. An ancient 2.24 meter stele inscribed with Hammurabi's Code can be seen in the Louvre. The laws are written in the Akkadian language, using cuneiform script.

Humanity's great ethical systems also began during a period when the social unit was growing very quickly. It is an interesting fact that many of history's greatest ethical teachers lived at a time when the human societies were rapidly increasing in size. One can think, for example of Moses, Confucius, Lao Tzu, Gautama Buddha, the Greek philosophers, and Jesus. Muhammad came slightly later, but he lived and taught at a time when tribal life was being replaced by city life in the Arab world. During the period when these great teachers lived, ethical systems had become necessary to over-write raw inherited human emotional behavior patterns in such a way that increasingly large societies could function in a harmonious and cooperative way, with a minimum of conflicts.



Figure 14.2: Hammurabi's code

14.2 The Ten Commandments

Here is a description of the Ten Commandments, as given in the chapter Exodus 20 of the King James Version of the Bible:

And God spake all these words, saying,

I am the Lord thy God, which have brought thee out of the land of Egypt, out of the house of bondage.

Thou shalt have no other gods before me.

Thou shalt not make unto thee any graven image, or any likeness of any thing that is in heaven above, or that is in the earth beneath, or that is in the water under the earth.

Thou shalt not bow down thyself to them, nor serve them: for I the Lord thy God am a jealous God, visiting the iniquity of the fathers upon the children unto the third and fourth generation of them that hate me;

And showing mercy unto thousands of them that love me, and keep my commandments.

Thou shalt not take the name of the Lord thy God in vain; for the Lord will not hold him guiltless that taketh his name in vain.

Remember the sabbath day, to keep it holy.

Six days shalt thou labor, and do all thy work:

But the seventh day is the sabbath of the Lord thy God: in it thou shalt not do any work, thou, nor thy son, nor thy daughter, thy manservant, nor thy maidservant, nor thy cattle, nor thy stranger that is within thy gates:

For in six days the Lord made heaven and earth, the sea, and all that in them is, and rested the seventh day: wherefore the Lord blessed the sabbath day, and hallowed it.

Honor thy father and thy mother: that thy days may be long upon the land which the Lord thy God giveth thee.

Thou shalt not kill.

Thou shalt not commit adultery.

Thou shalt not steal.

Thou shalt not bear false witness against thy neighbor.

Thou shalt not covet thy neighbor's house, thou shalt not covet thy neighbor's wife, nor his manservant, nor his maidservant, nor his ox, nor his ass, nor any thing that is thy neighbor's.

And all the people saw the thunderings, and the lightnings, and the noise of the trumpet, and the mountain smoking: and when the people saw it, they removed, and stood afar off.

And they said unto Moses, Speak thou with us, and we will hear: but let not God speak with us, lest we die.

And Moses said unto the people, Fear not: for God is come to prove you, and that his fear may be before your faces, that ye sin not.

And the people stood afar off, and Moses drew near unto the thick darkness where God was.

And the Lord said unto Moses, Thus thou shalt say unto the children of Israel, Ye have seen that I have talked with you from heaven.

Ye shall not make with me gods of silver, neither shall ye make unto you gods of gold.

An altar of earth thou shalt make unto me, and shalt sacrifice thereon thy burnt offerings, and thy peace offerings, thy sheep, and thine oxen: in all places where I record my name I will come unto thee, and I will bless thee.

And if thou wilt make me an altar of stone, thou shalt not build it of hewn stone: for if thou lift up thy tool upon it, thou hast polluted it.



Figure 14.3: The Ten Commandments

Neither shalt thou go up by steps unto mine altar, that thy nakedness be not discovered thereon.

14.3 The life and message of Gautama Buddha

Evidence of a very early river-valley civilization in India has been found at a site called Mohenjo-Daro. However, in about 2,500 B.C., this early civilization was destroyed by some great disaster, perhaps a series of floods; and for the next thousand years, little is known about the history of India. During this dark period between 2,500 B.C. and 1,500 B.C., India was invaded by the Indo-Aryans, who spoke Sanskrit, a language related to Greek. The Indo-Aryans partly drove out and partly enslaved the smaller and darker native Dravidians. However, there was much intermarriage between the groups, and to prevent further intermarriage, the Indo-Aryans introduced a caste system sanctioned by religion.

According to Hindu religious belief, the soul of a person who has died is reborn in another body. If, throughout his life, the person has faithfully performed the duties of his caste, then his or her soul may be reborn into a higher caste. Finally, after existing as a Brahman, the soul may be so purified that it can be released from the cycle of death and rebirth.

In the 6th century B.C., Gautama Buddha founded a new religion in India. Gautama Buddha was convinced that all the troubles of humankind spring from attachment to earthly things. He felt that the only escape from sorrow is through the renunciation of earthly desires. He also urged his disciples to follow a high ethical code, the Eightfold Way.

Among the sayings of Buddha are the following:

“Hatred does not cease by hatred at any time; hatred ceases by love.”

“Let a man overcome anger by love; let him overcome evil by good.”

“All men tremble at punishment. All men love life. Remember that you are like them, and do not cause slaughter.”

One of the early converts to Buddhism was the emperor Ashoka Maurya, who reigned in India between 273 B.C. and 232 B.C.. During one of his wars of conquest, Ashoka Maurya became so sickened by the slaughter that he resolved never again to use war as an instrument of policy. He became one of the most humane rulers in history, and he also did much to promote the spread of Buddhism throughout Asia.

Under the Mauryan dynasty (322 B.C. - 184 B.C.), the Gupta dynasty (320 B.C. - 500 A.D.) and also under the rajah Harsha (606 A.D. - 647 A.D.), India had periods of unity, peace and prosperity. At other times, the country was divided and upset by internal wars. The Gupta period especially is regarded as the golden age of India's classical past. During this period, India led the world in such fields as medicine and mathematics.

The Guptas established both universities and hospitals. According to the Chinese Buddhist pilgrim, Fa-Hsien, who visited India in 405 A.D., “The nobles and householders have founded hospitals within the city to which the poor of all countries, the destitute, crippled and diseased may go. They receive every kind of help without payment.”

Indian doctors were trained in cleansing wounds, in using ointments and in surgery. They also developed antidotes for poisons and for snakebite, and they knew some techniques for the prevention of disease through vaccination.

When they had completed their training, medical students in India took an oath, which resembled the Hippocratic oath: “Not for yourself, not for the fulfillment of any earthly desire or gain, but solely for the good of suffering humanity should you treat your patients.”

In Indian mathematics, algebra and trigonometry were especially highly developed. For example, the astronomer Brahmagupta (598 A.D. - 660 A.D.) applied algebraic methods to astronomical problems. The notation for zero and the decimal system were invented in India, probably during the 8th or 9th century A.D.. These mathematical techniques were later transmitted to Europe by the Arabs.

Many Indian techniques of manufacture were also transmitted to the west by the Arabs. Textile manufacture in particular was highly developed in India, and the Arabs, who were the middlemen in the trade with the west, learned to duplicate some of the most famous kinds of cloth. One kind of textile which they copied was called “quttan” by the Arabs, a word which in English has become “cotton”. Other Indian textiles included cashmere (Kashmir), chintz and calico (from Calcutta, which was once called Calicut). Muslin derives its name from Mosul, an Arab city where it was manufactured, while damask was made in Damascus.

Indian mining and metallurgy were also highly developed. The Europeans of the middle ages prized fine laminated steel from Damascus; but it was not in Damascus that the technique of making steel originated. The Arabs learned steelmaking from the Persians, and Persia learned it from India.

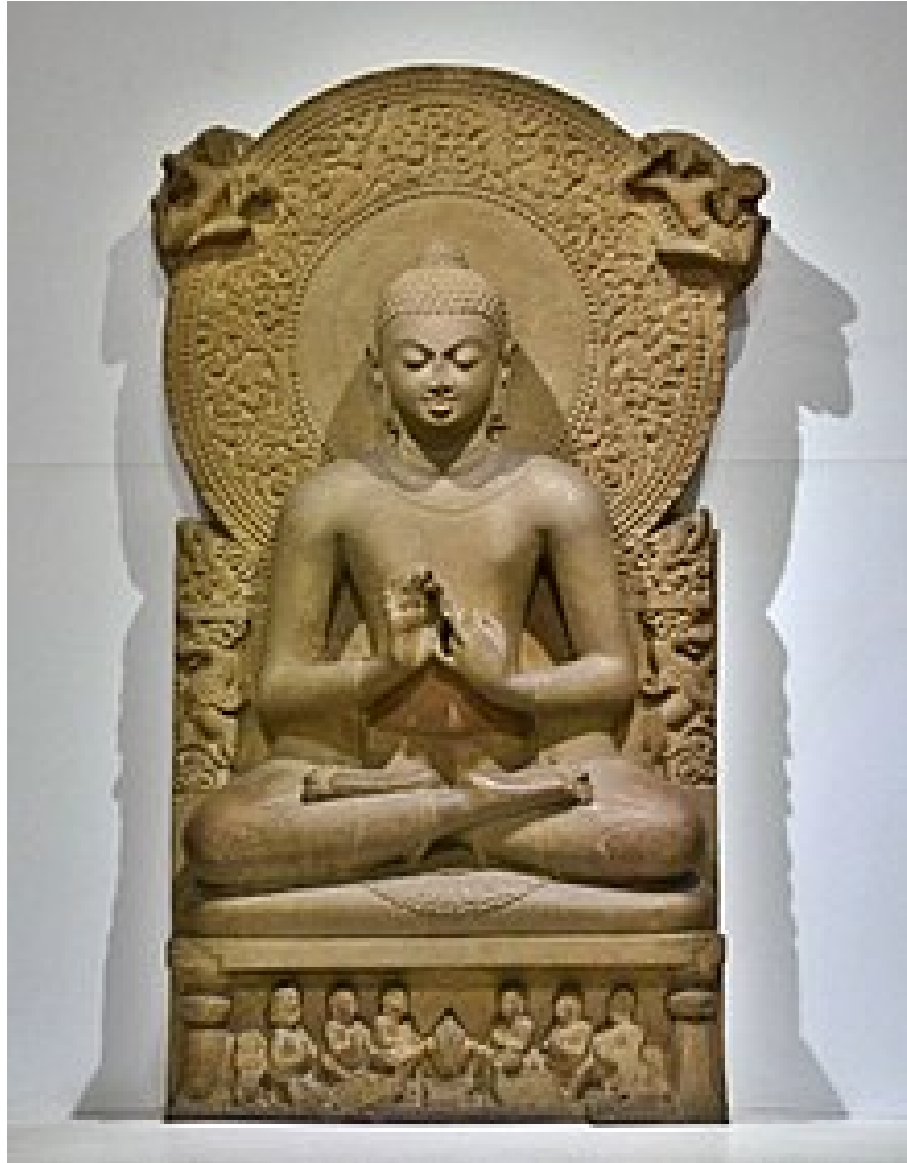

Figure 14.4: A statue of the Buddha from Sarnath, Uttar Pradesh, India, circa 475 CE. The Buddha is depicted teaching in the lotus position.

The Noble Eightfold Path

1. *Right understanding. And what is right understanding? There are fruits, and results of good and bad actions. There is this world and the next world. There is mother and father. There are spontaneously reborn beings; there are contemplatives and Brahmans who faring rightly and practicing rightly, proclaim this world and the next after having directly known and realized it for themselves.’ This is the right view with effluents, siding with merit, resulting in acquisitions*
2. *Right resolve. And what is right resolve? Being resolved on renunciation, on freedom from ill will, on harmlessness: This is called right resolve.*
3. *Right speech. And what is right speech? Abstaining from lying, from divisive speech, from abusive speech, and from idle chatter: This is called right speech.*
4. *Right action. And what is right action? Abstaining from killing, abstaining from stealing, abstaining from sexual misconduct. This is called right action.*
5. *Right livelihood. And what is right livelihood? Not possessing more than is strictly necessary. Avoiding causing suffering to sentient beings by cheating them, or harming or killing them in any way.*
6. *Right effort. And what is right effort? Here the monk arouses his will, puts forth effort, generates energy, exerts his mind, and strives to prevent the arising of evil and unwholesome mental states that have not yet arisen. He arouses his will... and strives to eliminate evil and unwholesome mental states that have already arisen, to keep them free of delusion, to develop, increase, cultivate, and perfect them. This is called right effort.*
7. *Right mindfulness. And what is right mindfulness? Here the monk remains contemplating the body as body, resolute, aware and mindful, having put aside worldly desire and sadness; he remains contemplating feelings as feelings; he remains contemplating mental states as mental states; he remains contemplating mental objects as mental objects, resolute, aware and mindful, having put aside worldly desire and sadness; This is called right mindfulness.*
8. *Right concentration. And what is right concentration? [i] Here, the monk, detached from sense-desires, detached from unwholesome states, enters and remains in the first jhana (level of concentration, in which there is applied and sustained thinking, together with joy and pleasure born of detachment; [ii] And through the subsiding of applied and sustained thinking, with the gaining of inner stillness and oneness of mind, he enters and remains in the second jhana, which is without applied and sustained thinking, and in which there are joy and pleasure born of concentration; [iii] And through the fading of joy, he remains equanimous, mindful and aware, and he experiences in his body the pleasure of which the Noble Ones say: “equanimous,*

mindful and dwelling in pleasure”, and thus he enters and remains in the third jhana; [iv] And through the giving up of pleasure and pain, and through the previous disappearance of happiness and sadness, he enters and remains in the fourth jhana, which is without pleasure and pain, and in which there is pure equanimity and mindfulness. This is called right concentration.

Some of the sayings of Gautama Buddha

In the end, only three things matter: How much you loved, how gently you lived, and how gracefully you let go of things not meant for you.

Buddha was asked, “What have you gained from meditation?” He replied NOTHING! However let me tell you what i have lost: anger, anxiety, depression, insecurity, fear of old age and death.

When the student is ready, the teacher will appear.

The less you respond to negative people, the more peaceful your life will become.

Health is the greatest gift, contentment is the greatest wealth, A trusted friend is the best relative, liberated mind is the greatest bliss.

The thought manifests as the word: the word manifests as the deed: the deed develops into character. So watch the thought and its ways with care, and let it spring from love born out of concern for all beings.

Do not learn how to react learn how to respond.

If your compassion does not include yourself, It is incomplete.

Everything that has a beginning has an ending. Make your peace with that and all will be well.

If anything is worth doing, do it with all your heart.

Your worst enemy cannot harm you as much as your own unguarded thoughts.

The root of suffering is attachment.

Holding onto anger is like drinking poison and expecting the other person to die.

All that we are is the result of what we have thought.

Do not dwell in the past, do not dream of the future, concentrate the mind on the present moment.

What you think you become, what you feel, you attract. what you imagine, you create.

Nothing can harm you as much as your own thoughts unguarded.

The trouble is you think you have time.

Your work is to discover your world and then with all your heart give yourself to it.

Believe nothing, no matter where you read it or who has said it, not even if i have said it. Unless it agrees with your own reason and your own common sense.

On the long journey of human life, Faith is the best of companions.

To understand everything is to forgive everything.

No one saves us but ourselves. No one can and no one may. We ourselves must walk the past.

There is no path to happiness: Happiness is the path.

No matter how hard the past, you can always begin again.

If you want to fly, give up everything that weighs you down.

You only lose what you cling to.

When we meet real tragedy in life, we can react in two ways- Either by losing hope and falling into self-destructive habits or by using the challenge to find our inner strength.

Don't rush anything. When the time is right, it will happen.

The whole secret of existence is to have no fear.

Be kind to all creatures; this is the true religion.

Those who are free of resentful thoughts surely find peace.

It is during our darkest moments that we must focus to see the light

Quiet the mind, and the soul will speak.

Each morning we are born again. What we do today is what matters most.

A man who conquers himself is greater than one who conquers a thousand men in a battle.

All human unhappiness comes from not facing reality squarely, exactly as it is.

It is better to be hated for what you are than to be loved for what you are not.

He who does not understand your silence will probably not understand your words.

You will not be punished for your anger, you will be punished by your anger.

Whatever befalls you, walk on untouched, unattached.

14.4 Confucius and Chinese civilization

After the fall of Rome in the 5th century A.D., Europe became a culturally backward area. However, the great civilizations of Asia and the Middle East continued to flourish, and it was through contact with these civilizations that science was reborn in the west.

During the dark ages of Europe, a particularly high level of civilization existed in China. The art of working in bronze was developed in China during the Shang dynasty (1,500 B.C. - 1,100 B.C.) and it reached a high pitch of excellence in the Chou dynasty (1,100 B.C. - 250 B.C.). “ In the Chou period, many of the cultural characteristics which we recognize as particularly Chinese were developed. During this period, the Chinese evolved a code of behavior based on politeness and ethics. Much of this code of behavior is derived from the teachings of K’ung Fu-tzu (Confucius), a philosopher and government official who lived between 551 B.C. and 479 B.C.. In his writings about ethics and politics, K’ung Fu-tzu advocated respect for tradition and authority, and the effect of his teaching was to strengthen the conservative tendencies in Chinese civilization. He was not a religious leader, but a moral and political philosopher, like the philosophers of ancient Greece. He is traditionally given credit for the compilation of the Five Classics of Chinese Literature, which include books of history, philosophy and poetry, together with rules for religious ceremonies.

Some sayings of Confucius

By three methods we may learn wisdom: First, by reflection, which is noblest; Second, by imitation, which is easiest; and third by experience, which is the bitterest.

Everything has beauty, but not everyone sees it.

Wheresoever you go, go with all your heart.

It does not matter how slowly you go as long as you do not stop.

Life is really simple, but we insist on making it complicated.

If you make a mistake and do not correct it, this is called a mistake.

The man who moves a mountain begins by carrying away small stones.

The funniest people are the saddest ones.

Before you embark on a journey of revenge, dig two graves.

To be wronged is nothing, unless you continue to remember it.

Respect yourself and others will respect you.

Silence is a true friend who never betrays.

You cannot open a book without learning something.

When you see a good person, think of becoming like her/him. When you see someone not so good, reflect on your own weak points.

Attack the evil that is within yourself, rather than attacking the evil that is in others.

The man who asks a question is a fool for a minute, the man who does not ask is a fool for life.

What the superior man seeks is in himself; what the small man seeks is in others.

I hear and I forget. I see and I remember. I do and I understand.

Music produces a kind of pleasure which human nature cannot do without.

The hardest thing of all is to find a black cat in a dark room, especially if there is no cat.

It is not the failure of others to appreciate your abilities that should trouble you, but rather your failure to appreciate theirs.

The man of wisdom is never of two minds; the man of benevolence never worries; the man of courage is never afraid.

The gem cannot be polished without friction, nor man perfected without trials.

Give a bowl of rice to a man and you will feed him for a day. Teach him how to grow his own rice and you will save his life.

Only the wisest and stupidest of men never change.

It is more shameful to distrust our friends than to be deceived by them.

Real knowledge is to know the extent of one's ignorance.

And remember, no matter where you go, there you are.

Hold faithfulness and sincerity as first principles.

If what one has to say is not better than silence, then one should keep silent.

Forget injuries, never forget kindnesses.

When it is obvious that the goals cannot be reached, don't adjust the goals, adjust the action steps.

Better a diamond with a flaw than a pebble without.

To put the world in order, we must first put the nation in order; to put the nation in order, we must first put the family in order; to put the family in order, we must first cultivate our personal life; we must first set our hearts right.

A lion chased me up a tree, and I greatly enjoyed the view from the top.

To be wealthy and honored in an unjust society is a disgrace.

In a country well governed, poverty is something to be ashamed of. In a country badly governed, wealth is something to be ashamed of.

If your plan is for one year plant rice. If your plan is for ten years plant trees. If your plan is for one hundred years educate children.



Figure 14.5: Confucius

Don't do unto others what you don't want done unto you.

Education breeds confidence. Confidence breeds hope. Hope breeds peace.

To see what is right and not do it is the worst cowardice.

Time flows away like the water in the river.

The superior man thinks always of virtue; the common man thinks of comfort.

14.5 Lao Tzu: Unity with nature

The rational teachings of K'ung Fu-tzu were complemented by the more mystical and intuitive doctrines of Lao Tzu and his followers. Lao Tzu lived at about the same time as K'ung Fu-tzu, and he founded the Taoist religion. The Taoists believed that unity with nature could be achieved by passively blending oneself with the forces of nature.

On the whole, politicians and scholars followed the practical teachings of K'ung Fu-tzu, while poets and artists became Taoists. The intuitive sensitivity to nature inspired by Taoist beliefs allowed these artists and poets to achieve literature and art of unusual vividness and force with great economy of means. The Taoist religion has much in common with Buddhism, and its existence in China paved the way for the spread of Buddhism from India to China and Japan.

From 800 B.C. onwards, the central authority of the Chou dynasty weakened, and China was ruled by local landlords. This period of disunity was ended in 246 B.C. by Shih Huang Ti, a chieftain from the small northern state of Ch'in, who became the first real emperor of China. (In fact, China derives its name from the state of Ch'in).

Shih Huang Ti was an effective but ruthless ruler. It was during his reign (246 B.C. -210 B.C.) that the great wall of China was built. This wall, built to protect China from the savage attacks of the mounted Mongolian hordes, is one of the wonders of the world. It runs 1,400 miles, over all kinds of terrain, marking a rainfall boundary between the rich agricultural land to the south and the arid steppes to the north.

In most places, the great wall is 25 feet high and 15 feet thick. To complete this fantastic building project, Shih Huang Ti carried absolutism to great extremes, uprooting thousands of families and transporting them to the comfortless north to work on the wall. He burned all the copies of the Confucian classics which he could find, since his opponents quoted these classics to show that his absolutism had exceeded proper bounds.

Soon after the death of Shih Huang Ti, there was a popular reaction to the harshness of his government, and Shih's heirs were overthrown. However, Shih Huang Ti's unification of China endured, although the Ch'in dynasty (250 B.C. - 202 B.C.) was replaced by the Han dynasty (202 B.C. -220 A.D.). The Han emperors extended the boundaries of China to the west into Turkestan, and thus a trade route was opened, through which China exported silk to Persia and Rome.

During the Han period, China was quite receptive to foreign ideas, and was much influenced by the civilization of India. For example, the Chinese pagoda was inspired by the Buddhist shrines of India. The Han emperors adopted Confucianism as the official philosophy of China, and they had the Confucian classics recopied in large numbers. The invention of paper at the end of the first century A.D. facilitated this project, and it greatly stimulated scholarship and literature.

The Han emperors honored scholarship and, in accordance with the political ideas of K'ung Fu-tzu, they made scholarship a means of access to high governmental positions. During the Han dynasty, the imperial government carried through many large-scale irrigation and flood-control projects. These projects were very successful. They increased the food production of China, and gave much prestige to the imperial government.

Like the Roman Empire, the Han dynasty was ended by attacks of barbarians from the north. However, the Huns who overran northern China in 220 A.D. were quicker to adopt civilization than were the tribes which conquered Rome. Also, in the south, the Chinese remained independent; and therefore the dark ages of China were shorter than the European dark ages.

In 581 A.D., China was reunited under the Sui dynasty, whose emperors expelled most of the Huns, built a system of roads and canals, and constructed huge granaries for the prevention of famine. These were worthwhile projects, but in order to accomplish them, the Sui emperors used very harsh methods. The result was that their dynasty was soon overthrown and replaced by the T'ang dynasty (618 A.D. - 906 A.D.).

The T'ang period was a brilliant one for China. Just as Europe was sinking further and further into a mire of superstition, ignorance and bloodshed, China entered a period

of peace, creativity and culture. During this period, China included Turkestan, northern Indochina and Korea. The T'ang emperors re-established and strengthened the system of civil-service examinations which had been initiated during the Han dynasty.

Some sayings of Lau Tzu

Being deeply loved by someone gives you strength, while loving someone deeply gives you courage.

Simplicity, patience, compassion. These three are your greatest treasures. Simple in actions and thoughts, you return to the source of being. Patient with both friends and enemies, you accord with the way things are. Compassionate toward yourself, you reconcile all beings in the world.

The journey of a thousand miles begins with a single step."

Knowing others is intelligence; knowing yourself is true wisdom. Mastering others is strength; mastering yourself is true power.

A good traveler has no fixed plans and is not intent on arriving.

Life is a series of natural and spontaneous changes. Don't resist them; that only creates sorrow. Let reality be reality. Let things flow naturally forward in whatever way they like.

Those who know do not speak. Those who speak do not know.

When you are content to be simply yourself and don't compare or compete, everyone will respect you.

The truth is not always beautiful, nor beautiful words the truth

When I let go of what I am, I become what I might be.

Time is a created thing. To say 'I don't have time,' is like saying, 'I don't want to.

Because one believes in oneself, one doesn't try to convince others. Because one is content with oneself, one doesn't need others' approval. Because one accepts oneself, the whole world accepts him or her.

A man with outward courage dares to die; a man with inner courage dares to live.

Care about what other people think and you will always be their prisoner.

If you are depressed you are living in the past. If you are anxious you are living in the future. If you are at peace you are living in the present.

Be careful what you water your dreams with. Water them with worry and fear and you will produce weeds that choke the life from your dream. Water them with optimism and solutions and you will cultivate success. Always be on the lookout for ways to turn a problem into an opportunity for success. Always be on the lookout for ways to nurture your dream.

Be content with what you have; rejoice in the way things are. When you realize there is nothing lacking, the whole world belongs to you.

Nature does not hurry, yet everything is accomplished.

Silence is a source of Great Strength.

Do you have the patience to wait until your mud settles and the water is clear?

If you understand others you are smart. If you understand yourself you are illuminated. If you overcome others you are powerful. If you overcome yourself you have strength. If you know how to be satisfied you are rich. If you can act with vigor, you have a will. If you don't lose your objectives you can be long-lasting. If you die without loss, you are eternal.

Kindness in words creates confidence. Kindness in thinking creates profoundness. Kindness in giving creates love.

Manifest plainness, Embrace simplicity, Reduce selfishness, Have few desires.

The flame that burns Twice as bright burns half as long.

Music in the soul can be heard by the universe.

Respond intelligently even to unintelligent treatment.

Act without expectation.



Figure 14.6: Lao Tzu

14.6 Socrates and Plato: Dialogues on ethics

The Sophists and Socrates

Since Athens was a democracy, the citizens often found themselves speaking at public meetings. Eloquence could be turned into influence, and the wealthy Athenians imported teachers to help them master the art of rhetoric. These teachers, called “Sophists” (literally “wisdomists”), besides teaching rhetoric, also taught a form of philosophy which denied the existence of absolute truth, absolute beauty and absolute justice. According to the Sophists, “man is the measure of all things”, all truths are relative, “beauty is in the eye of the beholder”, and justice is not divine or absolute but is a human institution.

Opposed to the Sophists was the philosopher Socrates, who believed passionately in the existence of the absolutes which the Sophists denied. According to Socrates, a beautiful object would be beautiful whether or not there were any humans to observe it. Socrates adopted from the Sophists a method of conducting arguments by asking questions which made people see for themselves the things which Socrates wanted them to see.

The Sophists talked about moral and political questions, rather than about the nature of the universe. Socrates was an opponent of the Sophists, but like them he also neglected the study of nature and concentrated on the moral and political problems of man, “the measure of all things”. The Sophists, together with Socrates and his pupil Plato, exerted a great influence in causing a split between moral philosophy and natural philosophy.

The beginning of the end of classical Greek civilization came in 431 B.C., when Athens, pushing her aggressive commercial policy to an extreme, began to expel Corinthian merchants from markets around the Aegean. Corinth reacted by persuading the Peloponesian

League to declare war on Athens. This was the beginning of a long war which ruined Greece.

Realizing that they could not resist the Spartan land forces, the Athenians abandoned the farmland outside their city, and took refuge inside the walls. The Athenians continued their prosperous foreign trade, and they fed their population with grain imported from the east. Ships bringing grain also brought the plague. A large part of the population of Athens died of the plague, including the city's great leader, Pericles. No leader of equal stature was found to replace him, and the democratic Athenian government degenerated into mob rule.

In 404 B.C., when the fleet of Athens was destroyed in a disastrous battle, the city surrendered to the Spartans. However, the Spartans remembered that without Athens, they would be unable to resist the Persian Empire. Therefore they did not destroy Athens totally, but were content to destroy the walls of Athens, reducing the city to the status of a satellite of Sparta.

Looking for scapegoats on whom to blame this disaster, the Athenian mobs seized Socrates (one of the few intellectuals who remained alive after the Peloponnesian War), and they condemned him to death for failing to believe in the gods of the city.

For a short period, Sparta dominated the Greek world; but soon war broke out again, and the political scene degenerated into a chaos of wars between the city states.

Plato

Darkness was falling on the classical Greek world, but the light of civilization had not quite gone out. Socrates was dead, but Plato, the student of Socrates, kept his memory alive by writing dialogues in which Socrates appeared as a character.

Plato (427 B.C. - 317 B.C.) was an Athenian aristocrat, descended from the early kings of Athens. His real name was Aristocles, but he was called by his nickname, Platon (meaning "broad") because of his broad shoulders. After the death of Socrates, Plato left Athens, saying that the troubles of the city would never end until a philosopher became king. (He may have had himself in mind!) He travelled to Italy and studied under the Pythagoreans. In 387 he returned to Athens and founded a school, which was called the Academy because it stood on ground which had once belonged to a Greek named Academus.

Plato developed a philosophy which was based on the idealism of the Pythagoreans. In Pythagorean philosophy, a clear distinction was made between mathematical ideas and their physical expression. For example, geometry was considered to deal, not with real physical objects, but with idealized figures, constructed from lines of perfect straightness and infinite thinness. Plato developed and exaggerated the idealism of Pythagoras. In Plato's philosophy, the real world is corruptible and base, but the world of ideas is divine and eternal. A real table, for example, is an imperfect expression of the idea of a table. Therefore we ought to turn our eyes away from the real world and live in the world of ideas.



Figure 14.7: **Socrates**



Figure 14.8: **Plato**

Plato's philosophy was just what the Athenians wanted! All around them, their world was crumbling. They gladly turned their backs on the unpleasantness of the real world, and accepted Plato's invitation to live in the world of ideas, where nothing decays and where the golden laws of mathematics rule eternally.

By all accounts, Plato was an excellent mathematician, and through his influence mathematics obtained a permanent place in education.

According to Plato, Socrates thought that knowledge is of the utmost importance because, since no man sins wittingly, only knowledge is needed to make men and women perfectly virtuous.

14.7 The ethical message of Greek drama

In ancient Greece, drama was an essential part of ethical culture. Performances of the plays of great dramatists, such as Sophocles, Aeschylus and Euripides, allowed the public to debate questions of morality. A recurring theme was the punishment of *hubris* (excessive pride) by *nemesis* (the revenge of the gods). Hubris is arrogance in word, deed and thought. For example, hubris is having or maintaining stubbornly an attitude which goes against or ignores, say, the prophecies, counsel or pronouncements of the Delphic Oracle. The central meaning of hubris is doing deeds and thinking thoughts more than a mere mortal human should do and think, thereby showing impiety towards the gods.

Starting in approximately 500 B.C., drama flourished in the Greek city-states, especially in Athens, which was an important cultural center. The presentation of dramas was part of a festival dedicated to the god Dionysus. Masks were used by the actors, and by members of the chorus. The chorus commented on the action, and often pointed to the moral that could be drawn from it.

The Trojan Women, by Euripides

An example of a Greek tragedy with ethical implications, *The Trojan Women* follows the fate of the women of Troy after all their husbands and sons had been slaughtered by the conquering Greeks. The play makes it clear to the audience that the conquering Greeks were guilty of *hubris*.

Lysistrata, by Aristophanes

Although *The Trojan Women* protested against the atrocities and horrors of war, the play did not attack the institution of war itself. However, in *Lysistrata*, a comedy by Aristophanes first performed in Athens in 411 B.C., war as an institution is attacked. In the play, the women of all parts of Greece are persuaded to withhold sex from their husbands and lovers until the painfully long Peloponnesian Wars are ended. After much comic struggle, the men, of course, give in and agree to peace, since their overpowering desire for sex is greater than their addiction to fighting.

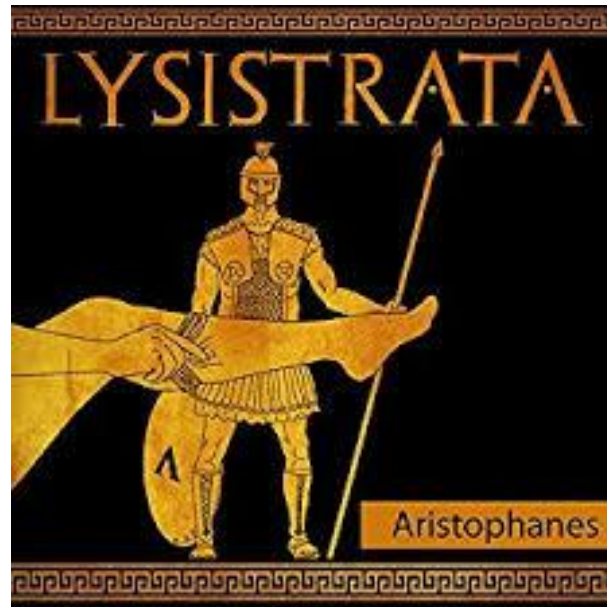

Figure 14.9: *Lysistrata*

14.8 Christian ethics

The three Abrahamic religions, Judaism, Christianity and Islam, have a total of 4 billion followers today, of which 2.4 billion are Christian. At its start, the Christian religion can be seen as a reform of Jewish traditions, a protest against the overly legalistic teachings of the Pharisees and a revelation of a new, more powerful and more universal system of ethics. Later, Saint Paul saw it as his mission to bring Christianity to the Gentiles (i.e. non-Jews).

If Christian ethics were really followed, war would be impossible, but wars have nevertheless persisted, and many of the most brutal wars have been fought in the name of Christianity. In the words of the American poet, Edna St. Vincent Millay,¹

*Up goes the man of God before the crowd.
 With voice of honey and with eyes of steel
 He drones your humble Gospel to the proud.
 Nobody listens, less than the wind that blows
 Are all your words to us you died to save.
 Oh Prince of Peace! O Sharon's dewy Rose!
 How mute you lie within your vaulted grave!
 The stone the angel rolled away with tears
 Is back upon your mouth these thousand years.*

¹from her poem. *To Jesus, on His Birthday*

The Seven Deadly Sins

Here is a list of important human failings as recognized by Christianity. They are rooted in emotions which we share with our animal ancestors. Today these emotions are inappropriate for civilized human society, and they must be overwritten by ethical principles.

1. *LUST* Regarding lust, Schopenhauer wrote: *Lust is the ultimate goal of almost all human endeavor, exerts an adverse influence on the most important affairs, interrupts the most serious business, sometimes for a while confuses even the greatest minds, does not hesitate with its trumpery to disrupt the negotiations of statesmen and the research of scholars, has the knack of slipping its love-letters and ringlets even into ministerial portfolios and philosophical manuscripts.*
2. *GLUTTONY* Saint Thomas Aquinas argued that gluttony could include, besides eating too much, an obsessive anticipation of meals, and the constant eating of delicacies and excessively costly foods. He even proposed five categories of Gluttony: *1. Laute: eating too expensively. 2. Studiose: eating too daintily. 3. Nimis: eating too much. 4. Praepropere: eating too soon. 5. Ardenter: eating too eagerly.*
3. *GREED* As defined outside Christian writings, greed is an inordinate desire to acquire or possess more than one needs, especially with respect to material wealth. Like pride, it can lead to not just some, but all evil. Saint Thomas Aquinas wrote: *Greed is a sin against God, just as all mortal sins, in as much as man condemns things eternal for the sake of temporal things.* In the New Testament, we can find many passages condemning greed, for example: *For the love of money is the root of all evil: which while some coveted after, they have erred from the faith, and pierced themselves through with many sorrows.* Timothy 6:10, and *Lay not up for yourselves treasures upon earth, where moth and rust doth corrupt, and where thieves break through and steal.* Mathew 6:19
4. *SLOTH* Unlike the other deadly sins, Sloth is characterized by sins of omission. In his play *Per Gynt*, Henrik Ibsen portrays his protagonist as hearing voices which tell him: *We are the tears you should have shed. That cutting ice, which all hearts dread, we could have melted, but now its dart is frozen into a stubborn heart. Our power is lost. We are the deeds you should have done, strangled by doubt, spoiled e're begun. At the judgement day, we will be there to tell our tale. How will you fare?* *Per Gynt* answers: *You can't condemn a man for what he has not done!*, but Ibsen's message is: Yes, you can condemn a person for sins of omission. They too are deadly sins.
5. *WRATH* According to the Catholic Church, *Hatred is the sin of desiring that someone else may suffer misfortune or evil, and is a mortal sin when one desires grave harm.* The Catholic Church also states that *If anger reaches the point of a deliberate desire to kill or seriously wound a neighbor, it is gravely against charity; it is a mortal*

sin. We can also remember the words of Gautama Buddha, *Hatred does not cease by hatred at any time; hatred ceases by love.*

6. *ENVY* Envy can be directly related to the Ten Commandments, specifically, *Neither shall you covet... anything that belongs to your neighbor.* If we are free from envy, our happiness is greatly increased, since we can derive pleasure from the success and happiness of others.
7. *PRIDE* C.S. Lewis wrote that *Unchastity, anger, greed, drunkenness, and all that, are mere fleabites in comparison: it was through Pride that the devil became the devil: Pride leads to every other vice: it is the complete anti-God state of mind.* In ancient Greece, both philosophers and dramatists considered excessive pride, which they called *hubris*, to be a sin against the gods, which always led to punishment. According to Wikipedia, *Hubris means extreme pride or arrogance. Hubris often indicates a loss of contact with reality, and an overestimation of one's own competence or capabilities, especially when the person exhibiting it is in a position of power.... The word is also used to describe actions of those who challenged the gods or their laws, especially in Greek tragedy, resulting in the protagonist's fall.* We can think, for example of the Titanic. The invention and use of nuclear weapons can also be thought of as an example of *hubris*.

Excerpts from *The Sermon on the Mount*

Many of the important ethical principles of Christianity are contained in the Sermon on the Mount. Here is the first part of the sermon, as given by the Gospel According to Mathew, Chapter 6:

And seeing the multitudes, he went up into a mountain: and when he was set, his disciples came unto him: And he opened his mouth, and taught them, saying,

Blessed are the poor in spirit: for theirs is the kingdom of heaven.

Blessed are they that mourn: for they shall be comforted.

Blessed are the meek: for they shall inherit the earth.

Blessed are they which do hunger and thirst after righteousness: for they shall be filled.

Blessed are the merciful: for they shall obtain mercy.

Blessed are the pure in heart: for they shall see God.

Blessed are the peacemakers: for they shall be called the children of God.

Blessed are they which are persecuted for righteousness' sake: for theirs is the kingdom of heaven.

Blessed are ye, when men shall revile you, and persecute you, and shall say all manner of evil against you falsely, for my sake.

Rejoice, and be exceeding glad: for great is your reward in heaven: for so persecuted they the prophets which were before you.

Ye are the salt of the earth: but if the salt have lost his savour, wherewith shall it be salted? it is thenceforth good for nothing, but to be cast out, and to be trodden under foot of men.

Ye are the light of the world. A city that is set on an hill cannot be hid. Neither do men light a candle, and put it under a bushel, but on a candlestick; and it giveth light unto all that are in the house.

Let your light so shine before men, that they may see your good works, and glorify your Father which is in heaven.

Think not that I am come to destroy the law, or the prophets: I am not come to destroy, but to fulfil.

For verily I say unto you, Till heaven and earth pass, one jot or one tittle shall in no wise pass from the law, till all be fulfilled.

Whosoever therefore shall break one of these least commandments, and shall teach men so, he shall be called the least in the kingdom of heaven: but whosoever shall do and teach them, the same shall be called great in the kingdom of heaven.

For I say unto you, That except your righteousness shall exceed the righteousness of the scribes and Pharisees, ye shall in no case enter into the kingdom of heaven.

Ye have heard that it was said by them of old time, Thou shalt not kill; and whosoever shall kill shall be in danger of the judgment:

But I say unto you, That whosoever is angry with his brother without a cause shall be in danger of the judgment: and whosoever shall say to his brother, Raca, shall be in danger of the council: but whosoever shall say, Thou fool, shall be in danger of hell fire.

Therefore if thou bring thy gift to the altar, and there rememberest that thy brother hath ought against thee;

Leave there thy gift before the altar, and go thy way; first be reconciled to thy brother, and then come and offer thy gift.

Agree with thine adversary quickly, whiles thou art in the way with him; lest at any time the adversary deliver thee to the judge, and the judge deliver thee to the officer, and thou be cast into prison.

Verily I say unto thee, Thou shalt by no means come out thence, till thou hast paid the uttermost farthing. Ye have heard that it was said by them of old time, Thou shalt not commit adultery:

But I say unto you, That whosoever looketh on a woman to lust after her hath committed adultery with her already in his heart.

And if thy right eye offend thee, pluck it out, and cast it from thee: for it is profitable for thee that one of thy members should perish, and not that thy whole body should be cast into hell.

And if thy right hand offend thee, cut it off, and cast it from thee: for it is profitable for thee that one of thy members should perish, and not that thy whole body should be cast into hell.

It hath been said, Whosoever shall put away his wife, let him give her a writing of divorcement: But I say unto you, That whosoever shall put away his wife, saving for the cause of fornication, causeth her to commit adultery: and whosoever shall marry her that is divorced committeth adultery.

Again, ye have heard that it hath been said by them of old time, Thou shalt not forswear thyself, but shalt perform unto the Lord thine oaths:

But I say unto you, Swear not at all; neither by heaven; for it is God's throne:

Nor by the earth; for it is his footstool: neither by Jerusalem; for it is the city of the great King. Neither shalt thou swear by thy head, because thou canst not make one hair white or black. But let your communication be, Yea, yea; Nay, nay: for whatsoever is more than these cometh of evil. Ye have heard that it hath been said, An eye for an eye, and a tooth for a tooth:

But I say unto you, That ye resist not evil: but whosoever shall smite thee on thy right cheek, turn to him the other also.

And if any man will sue thee at the law, and take away thy coat, let him have thy cloke also.

And whosoever shall compel thee to go a mile, go with him twain.

Give to him that asketh thee, and from him that would borrow of thee turn not thou away.

Ye have heard that it hath been said, Thou shalt love thy neighbour, and hate thine enemy.

But I say unto you, Love your enemies, bless them that curse you, do good to them that hate you, and pray for them which despitefully use you, and persecute you;

That ye may be the children of your Father which is in heaven: for he maketh his sun to rise on the evil and on the good, and sendeth rain on the just and on the unjust.

For if ye love them which love you, what reward have ye? do not even the publicans the same?

And if ye salute your brethren only, what do ye more than others? do not even the publicans so?

Be ye therefore perfect, even as your Father which is in heaven is perfect.

Notice particularly that Christians are required to love their enemies and to do good to those who have wronged them. This seemingly impractical advice is in fact very practical. Endless escalating cycles of revenge and counter-revenge can only be prevented by unilateral acts of kindness.

But do the governments of supposedly Christian countries follow this commandment? Absolutely not! As Edna St. Vincent Millay says, “Nobody listens. Less than the winds that blow are all your words to us you died to save.”

Contrast the duty to love and do good to one’s enemies with the doctrine of massive retaliation which is built into the concept of nuclear deterrence. In a nuclear war, the hundreds of millions, or even billions, of victims in every country of the world, also neutral countries, would include people of every kind: women, men, old people, children and infants, completely irrespective of any degree of guilt that they might have. This type of killing has to be classified as genocide.

If Christians were true to their beliefs, not only nuclear war, but every kind of war would be forbidden to them.

The Parable of the Good Samaritan

All of the major religions of humanity contain some form of the Golden Rule. Christianity offers an especially clear statement of this central ethical principle: According to the



Figure 14.10: An ikon depicting Jesus

Gospel of Luke, after being told that he must love his neighbor as much as he loves himself, a man asks Jesus, "Who is my neighbor?". Jesus then replies with the Parable of the Good Samaritan, in which we are told that our neighbor need not be a member of our own tribe, but can live far away and can belong to a completely different nation or ethnic group. Nevertheless, that person is still our neighbor, and deserves our love and care.

And, behold, a certain lawyer stood up, and tempted him, saying, Master, what shall I do to inherit eternal life?

He said unto him, What is written in the law? how readest thou?

And he answering said, Thou shalt love the Lord thy God with all thy heart, and with all thy soul, and with all thy strength, and with all thy mind; and thy neighbour as thyself.

And he said unto him, Thou hast answered right: this do, and thou shalt live.

But he, willing to justify himself, said unto Jesus, And who is my neighbour?

And Jesus answering said, A certain man went down from Jerusalem to Jericho, and fell among thieves, which stripped him of his raiment, and wounded him, and departed, leaving him half dead.

And by chance there came down a certain priest that way: and when he saw him, he passed by on the other side.

And likewise a Levite, when he was at the place, came and looked on him, and passed by on the other side.

But a certain Samaritan, as he journeyed, came where he was: and when he saw him, he had compassion on him,

And went to him, and bound up his wounds, pouring in oil and wine, and set him on his own beast, and brought him to an inn, and took care of him.

And on the morrow when he departed, he took out two pence, and gave them to the host, and said unto him, Take care of him; and whatsoever thou spendest more, when I come again, I will repay thee.

Which now of these three, thinkest thou, was neighbour unto him that fell among the thieves?

And he said, He that shewed mercy on him. Then said Jesus unto him, Go, and do thou likewise.

Saint Paul's letter to the Corinthians

If I speak in the tongues of men or of angels, but do not have love, I am only a resounding gong or a clanging cymbal. If I have the gift of prophecy and can fathom all mysteries and all knowledge, and if I have a faith that can move mountains, but do not have love, I am nothing. If I give all I possess to the poor and give over my body to hardship that I may boast, but do not have love, I gain nothing.

Love is patient, love is kind. It does not envy, it does not boast, it is not proud. It does not dishonor others, it is not self-seeking, it is not easily angered, it keeps no record of wrongs. Love does not delight in evil but rejoices with the truth. It always protects, always trusts, always hopes, always perseveres. Love never fails. But where there are prophecies,

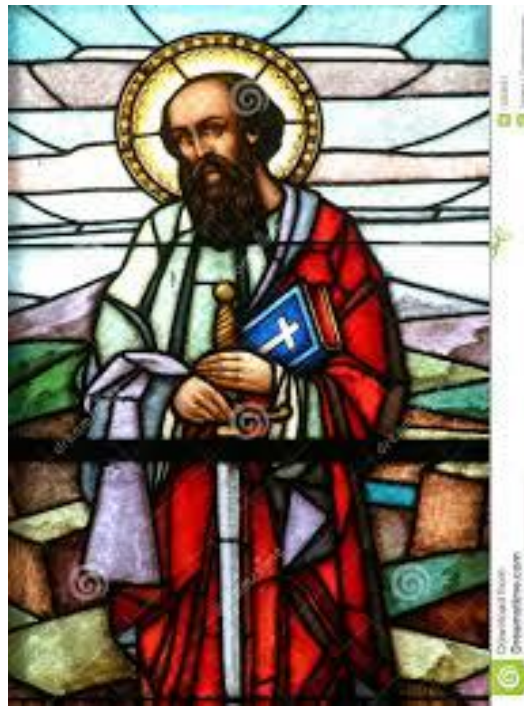

Figure 14.11: **Saint Paul**

they will cease; where there are tongues, they will be stilled; where there is knowledge, it will pass away. For we know in part and we prophesy in part, but when completeness comes, what is in part disappears. When I was a child, I talked like a child, I thought like a child, I reasoned like a child. When I became a man, I put the ways of childhood behind me. For now we see only a reflection as in a mirror; then we shall see face to face. Now I know in part; then I shall know fully, even as I am fully known.

And now these three remain: faith, hope and love. But the greatest of these is love.



Figure 14.12: Saint Francis, in a painting by Giotto, preaching to the birds. Today Pope Francis I carries to us the message of Saint Francis. Pope Francis tells us that the true interpretation of Christianity includes respect for nature, social justice and opposition to the institution of war.

14.9 The ethical message of Islam

Some Islamic contributions to civilization

In the 5th century A.D., there was a split in the Christian church of Byzantium; and the Nestorian church, separated from the official Byzantine church. The Nestorians were bitterly persecuted by the Byzantines, and therefore they migrated, first to Mesopotamia, and later to south-west Persia. (Some Nestorians migrated as far as China.)

During the early part of the middle ages, the Nestorian capital at Gondisapur was a great center of intellectual activity. The works of Plato, Aristotle, Hippocrates, Euclid, Archimedes, Ptolemy, Hero and Galen were translated into Syriac by Nestorian scholars, who had brought these books with them from Byzantium.

Among the most distinguished of the Nestorian translators were the members of a family called Bukht-Yishu (meaning “Jesus hath delivered”), which produced seven generations of outstanding scholars. Members of this family were fluent not only in Greek and Syriac, but also in Arabic and Persian.

In the 7th century A.D., the Islamic religion suddenly emerged as a conquering and proselytizing force. Inspired by the teachings of Mohammad (570 A.D. - 632 A.D.), the Arabs and their converts rapidly conquered western Asia, northern Africa, and Spain. During the initial stages of the conquest, the Islamic religion inspired a fanaticism in its followers which was often hostile to learning. However, this initial fanaticism quickly changed to an appreciation of the ancient cultures of the conquered territories; and during

the middle ages, the Islamic world reached a very high level of culture and civilization.

Thus, while the century from 750 to 850 was primarily a period of translation from Greek to Syriac, the century from 850 to 950 was a period of translation from Syriac to Arabic. It was during this latter century that Yuhanna Ibn Masawiah (a member of the Bukht-Yishu family, and medical advisor to Caliph Harun al-Rashid) produced many important translations into Arabic.

The skill of the physicians of the Bukht-Yishu family convinced the Caliphs of the value of Greek learning; and in this way the family played an extremely important role in the preservation of the western cultural heritage. Caliph al-Mamun, the son of Harun al-Rashid, established at Baghdad a library and a school for translation, and soon Baghdad replaced Gondisapur as a center of learning.

The English word "chemistry" is derived from the Arabic words "*al-chimia*", which mean "the changing". The earliest alchemical writer in Arabic was Jabir (760-815), a friend of Harun al-Rashid. Much of his writing deals with the occult, but mixed with this is a certain amount of real chemical knowledge. For example, in his *Book of Properties*, Jabir gives the following recipe for making what we now call lead hydroxycarbonate (white lead), which is used in painting and pottery glazes: "Take a pound of litharge, powder it well and heat it gently with four pounds of vinegar until the latter is reduced to half its original volume. Then take a pound of soda and heat it with four pounds of fresh water until the volume of the latter is halved. Filter the two solutions until they are quite clear, and then gradually add the solution of soda to that of the litharge. A white substance is formed, which settles to the bottom. Pour off the supernatant water, and leave the residue to dry. It will become a salt as white as snow."

Another important alchemical writer was Rhazes (c. 860 - c. 950). He was born in the ancient city of Ray, near Teheran, and his name means "the man from Ray". Rhazes studied medicine in Baghdad, and he became chief physician at the hospital there. He wrote the first accurate descriptions of smallpox and measles, and his medical writings include methods for setting broken bones with casts made from plaster of Paris. Rhazes was the first person to classify substances into vegetable, animal and mineral. The word "*al-kali*", which appears in his writings, means "the calcined" in Arabic. It is the source of our word "alkali", as well as of the symbol K for potassium.

The greatest physician of the middle ages, Avicenna, (Abu-Ali al Hussain Ibn Abdullah Ibn Sina, 980-1037), was also a Persian, like Rhazes. More than a hundred books are attributed to him. They were translated into Latin in the 12th century, and they were among the most important medical books used in Europe until the time of Harvey. Avicenna also wrote on alchemy, and he is important for having denied the possibility of transmutation of elements.

In mathematics, one of the most outstanding Arabic writers was al-Khwarizmi (c. 780 - c. 850). The title of his book, *Ilm al-jabr wa'd muqabalah*, is the source of the English word "algebra". In Arabic *al-jabr* means "the equating". Al-Khwarizmi's name has also become an English word, "algorism", the old word for arithmetic. Al-Khwarizmi drew from both Greek and Hindu sources, and through his writings the decimal system and the use of zero were transmitted to the west.

One of the outstanding Arabic physicists was al-Hazen (965-1038). He made the mistake of claiming to be able to construct a machine which could regulate the flooding of the Nile. This claim won him a position in the service of the Egyptian Caliph, al-Hakim. However, as al-Hazen observed Caliph al-Hakim in action, he began to realize that if he did not construct his machine *immediately*, he was likely to pay with his life! This led al-Hazen to the rather desperate measure of pretending to be insane, a ruse which he kept up for many years. Meanwhile he did excellent work in optics, and in this field he went far beyond anything done by the Greeks.

Al-Hazen studied the reflection of light by the atmosphere, an effect which makes the stars appear displaced from their true positions when they are near the horizon; and he calculated the height of the atmospheric layer above the earth to be about ten miles. He also studied the rainbow, the halo, and the reflection of light from spherical and parabolic mirrors. In his book, *On the Burning Sphere*, he shows a deep understanding of the properties of convex lenses. Al-Hazen also used a dark room with a pin-hole opening to study the image of the sun during an eclipses. This is the first mention of the *camera obscura*, and it is perhaps correct to attribute the invention of the *camera obscura* to al-Hazen.

Another Islamic philosopher who had great influence on western thought was Averröes, who lived in Spain from 1126 to 1198. His writings took the form of thoughtful commentaries on the works of Aristotle. He shocked both his Moslem and his Christian readers by maintaining that the world was not created at a definite instant, but that it instead evolved over a long period of time, and is still evolving.

Like Aristotle, Averröes seems to have been groping towards the ideas of evolution which were later developed in geology by Steno, Hutton and Lyell and in biology by Darwin and Wallace. Much of the scholastic philosophy which developed at the University of Paris during the 13th century was aimed at refuting the doctrines of Averröes; but nevertheless, his ideas survived and helped to shape the modern picture of the world.

A few verses from the Quran

1. THE OPENING:

All praise is due to Allah, the Lord of the Worlds.

The Beneficent, the Merciful.

Master of the Day of Judgment.

Thee do we serve and Thee do we beseech for help.

Keep us on the right path.

The path of those upon whom Thou hast bestowed favors.

Not (the path) of those upon whom Thy wrath is brought down, nor of those who go astray.

107. ALMS

In the name of Allah, the Beneficent, the Merciful.

Have you considered him who calls the judgment a lie?

That is the one who treats the orphan with harshness,

*And does not urge (others) to feed the poor.
 So woe to the praying ones,
 Who are unmindful of their prayers,
 Who do (good) to be seen,
 And withhold the necessities of life.*

109. *THE DISBELIEVERS*

In the name of Allah, the Beneficent, the Merciful.

Say: O unbelievers!

I do not serve that which you serve,

Nor do you serve Him Whom I serve:

Nor am I going to serve that which you serve,

Nor are you going to serve Him Whom I serve:

You shall have your religion and I shall have my religion.

112. *THE UNITY*

In the name of Allah, the Beneficent, the Merciful.

Say: He, Allah, is One.

Allah is He on Whom all depend.

He begets not, nor is He begotten.

And none is like Him.

113. *THE DAWN*

In the name of Allah, the Beneficent, the Merciful.

Say: I seek refuge in the Lord of the dawn,

From the evil of what He has created,

And from the evil of the utterly dark night when it comes,

And from the evil of those who blow on knots,

And from the evil of the envious when he envies.

114. *THE PEOPLE*

In the name of Allah, the Beneficent, the Merciful.

Say: I seek refuge in the Lord of men,

The King of men,

The God of men,

From the evil of the whisperings of the slinking (Shaitan),

Who whispers into the hearts of men,

From among the jinn and the men.



Figure 14.13: Mosaics at the Alhambra



Figure 14.14: Mosaics at the Alhambra



Figure 14.15: The interior of the great mosque at Isfahan

14.10 East-West exchanges in Toledo

In the 12th century, parts of Spain, including the city of Toledo, were reconquered by the Christians. Toledo had been an Islamic cultural center, and many Muslim scholars, together with their manuscripts, remained in the city when it passed into the hands of the Christians. Thus Toledo became a center for the exchange of ideas between east and west; and it was in this city that many of the books of the classical Greek and Hellenistic philosophers were translated from Arabic into Latin.

Toledo had been an Islamic cultural center, and many Moslem scholars, together with their manuscripts, remained in the city when it passed into the hands of the Christians. Thus Toledo became a center for the exchange of ideas between east and west; and it was in this city that many of the books of the classical Greek and Hellenistic philosophers were translated from Arabic into Latin. By this roundabout route the culture that was lost because of the burning of the Great Library at Alexandria reentered the consciousness of Europe and contributed to the Renaissance.

In the 12th century, the translation was confined to books of science and philosophy. Classical Greek literature was forbidden by both the Christian and Moslem religions; and the beautiful poems and dramas of Homer, Sophocles and Euripides were not translated into Latin until the time of the Renaissance Humanists.

It is interesting and inspiring to visit Toledo. A tourist there can see ample evidence of a period of tolerance and enlightenment, when members of the three Abrahamic religions, Christianity, Judaism and Islam, lived side by side in harmony and mutual respect, exchanging important ideas which were to become the foundations of our modern civilization. One can also see a cathedral, a mosque and a synagogue, in each of which craftsmen from all three faiths worked cooperatively to produce a beautiful monument to human solidarity.



Figure 14.16: A view of Toledo

14.11 Tolstoy, Gandhi and non-violence

Leo Tolstoy was born in 1828. While he was still a child, his parents died, and he became Count Tolstoy, with responsibility for the family estate at Yasnaya Polyana. As a young man, he was attracted to the gay and worldly social life of Moscow, but his diary during this period shows remorse over his pursuit of sensual pleasures. Disgusted with himself, he entered the army, and during idle periods he began his career as a writer. While still a soldier, he published a beautiful nostalgic work entitled “Childhood” as well as a number of skillful stories describing army life.

Schools and textbooks for peasants

At the age of 28, Tolstoy left the army and spent a brief period as a literary idol in St. Petersburg. He then became concerned about lack of education among Russian peasants, and he traveled widely in Europe, studying educational theory and methods. Returning to Yasnaya Polyana, he established schools for the peasants, published an educational magazine and compiled a number of textbooks whose simplicity and attractiveness anticipated modern teaching methods.

Tolstoy’s great novels

Tolstoy married in 1862 at the age of 34. His wife, Sonya Bers, shared his wide intellectual interests, and they had a happy family life with thirteen children¹. During this period, Tolstoy managed his estate with much success, and he produced his great literary masterpieces “War and Peace” and “Anna Karenina”. He modeled the characters in “War and Peace” after members of his own family. For example, Tolstoy’s famous heroine, Natasia, is modeled after his sister-in-law, Tanya Bers. Pierre in “War and Peace” and Levin

in “Anna Karenina” reflect Tolstoy’s own efforts to understand the meaning of life, his concern with the misery of the Russian peasants, and his ultimate conclusion that true happiness and peace of mind can only be found in a simple life devoted to the service of others.

Search for life’s meaning

By the time Tolstoy had finished “Anna Karenina”, he had become very dissatisfied with the life that he was leading. Despite having achieved in great measure all of the goals for which humans usually strive, he felt that his existence lacked meaning; and in 1879 he even contemplated suicide. He looked for life’s purpose by systematically studying the writings of scientists and philosophers, but he could not find an answer there that satisfied him.

Finally Tolstoy found inspiration in the humble and devout lives of the peasants. He decided that the teachings of Jesus, as recorded in the New Testament, could provide the answer for which he was searching. Tolstoy published an account of his spiritual crisis in a book entitled “A Confession”, in which he says:

“I searched for enlightenment everywhere in the hard-won accumulated knowledge of mankind. I searched passionately and long, not in a lazy way, but with my whole soul, day and night. I searched like a drowning man looking for safety - and found nothing. I searched all the sciences, and not only did I find nothing, but I also came to the conclusion that everyone who, like myself, had searched in the sciences for life’s meaning had also found nothing.”

“I then diligently studied the teachings of Buddhism and Islam in the holy books of those religions; but most of all I studied Christianity as I met it in the holy Scriptures and in the living Christians around me...”

Love for the poor

“I began to approach the believers among the poor, simple ignorant people: pilgrims, monks and peasants... The whole life of Christians of our own circle seemed to be a contradiction of their faith. By contrast, the whole life of Christians of the peasant class was an affirmation of the view of life which their religious faith gave to them. I looked more and more deeply into the faith of these people, and the more deep my insight became, the more I became convinced that they had a genuine belief, that their faith was essential to them, and that it was their faith alone which gave their life a meaning and made it possible for them to live... I developed a love for these simple people.”

Moved by the misery of the urban poor whom he encountered in the slums of Moscow, Tolstoy wrote: “Between us, the rich and the poor, there is a wall of false education, and before we can help the poor, we must first tear down that wall. I was forced to the conclusion that our own wealth is the true cause of the misery of the poor.”

What Then Must We Do?

Tolstoy's book, "What Then Must We Do?", tells of his experiences in the slums and analyses the causes of poverty. Tolstoy felt that the professed Christian belief of the Czarist state was a thin cosmetic layer covering a structure that was fundamentally built on violence. Violence was used to maintain a huge gap between the rich and the poor, and violence was used in international relations. Tolstoy felt especially keenly the contradiction between Christianity and war. In a small book entitled "The Kingdom of God is Within Us" he wrote:

The contradiction between Christianity and war

"All other contradictions are insignificant compared with the contradiction which now faces humankind in international relations, and which cries out for a solution, since it brings the very existence of civilization into danger. This is the contradiction between the Christian conscience and war."

"All of the Christian peoples of the world, who all follow one and the same spiritual life, so that any good and fruitful thought which is put forward in any corner of the world is immediately communicated to all of Christendom, where it arouses feelings of pride and happiness in us regardless of our nationality; we who simply love the thinkers, humanitarians, and poets of other countries; we who not only admire their achievements, but also feel delight in meeting them and greet them with friendly smiles; we will all be forced by the state to participate in a murderous war against these same people, a war which if it does not break out today will do so tomorrow."

"...The sharpest of all contradictions can be seen between the government's professed faith in the Christian law of the brotherhood of all humankind, and the military laws of the state, which force each young man to prepare himself for enmity and murder, so that each must be simultaneously a Christian and a gladiator."

Banned and excommunicated

Tolstoy's writings on Christianity and on social questions were banned by the public censor, and he was excommunicated from the Russian Orthodox Church. However, his universally recognized stature as one of the world's greatest writers was undiminished, and his beliefs attracted many followers, both inside and outside of Russia.

Tolstoy and Gandhi

In 1894, the young Indian lawyer, Mohandas K. Gandhi, (who was then working for the civil rights of Indians in South Africa), read Tolstoy's books on Christianity and was greatly influenced by them. Gandhi wrote a review of "The Kingdom of God is Within Us", and in 1909 he sent Tolstoy an account of the activities of the civil rights movement in South Africa. He received a reply in which Tolstoy said:

“...The longer I live, and especially now, when I vividly feel the nearness of death, the more I want to tell others what I feel so particularly clearly and what to my mind is of great importance, namely that which is called passive resistance, but which is in reality nothing else but the teaching of love, uncorrupted by false interpretations. That love, i.e. the striving for the union of human souls and the activity derived from that striving, is the highest and only law of human life, and in the depth of his soul every human being knows this (as we most clearly see in children); he knows this until he is entangled in the false teachings of the world. This law was proclaimed by all, by the Indian as by the Chinese, Hebrew, Greek and Roman sages of the world. I think that this law was most clearly expressed by Christ, who plainly said that in this alone is all the law and the prophets...”

“...The peoples of the Christian world have solemnly accepted this law, while at the same time they have permitted violence and built their lives on violence; and that is why the whole life of the Christian peoples is a continuous contradiction between what they profess, and the principles on which they order their lives - a contradiction between love accepted as the law of life, and violence which is recognized and praised, acknowledged even as a necessity in different phases of life, such as the power of rulers, courts, and armies...”

“This year, in the spring, at a Scripture examination in a girls’ high school in Moscow, the teacher and the bishop present asked the girls questions on the Commandments, and especially on the sixth. After a correct answer, the bishop generally put another question, whether murder was always in all cases forbidden by God’s law; and the unhappy young ladies were forced by previous instruction to answer ‘not always’ - that murder was permitted in war and in the execution of criminals. Still, when one of these unfortunate young ladies (what I am telling is not an invention, but a fact told to me by an eye witness) after her first answer, was asked the usual question, if killing was always sinful, she, agitated and blushing, decisively answered ‘Always’, and to all the usual sophisms of the bishop, she answered with decided conviction that killing always was forbidden in the Old Testament and forbidden by Christ, not only killing, but every wrong against a brother. Notwithstanding all his grandeur and arts of speech, the bishop became silent and the girl remained victorious.”

Nonviolent resistance to governmental violence

Tolstoy believed that violence can never under any circumstances be justified, and that therefore an individual’s resistance to governmental violence must be passive and non-violent. He also believed that each individual ought to reduce his needs to a minimum in order to avoid exploiting the labor of others.

Tolstoy gave up meat, alcohol, tobacco, and hunting. He began to clean his own room, wore simple peasant clothes, worked in the fields, and made his own boots. He participated in famine relief, and he would have liked to give away all of his great wealth to feed the poor, but bowing to the protests of his family, he gave his wealth to them instead. Because he had been unable to convert his family to his beliefs, Tolstoy left home secretly on a November night in 1910, accompanied, like King Lear, by his youngest daughter. He died of pneumonia a few days later at a remote railway junction.

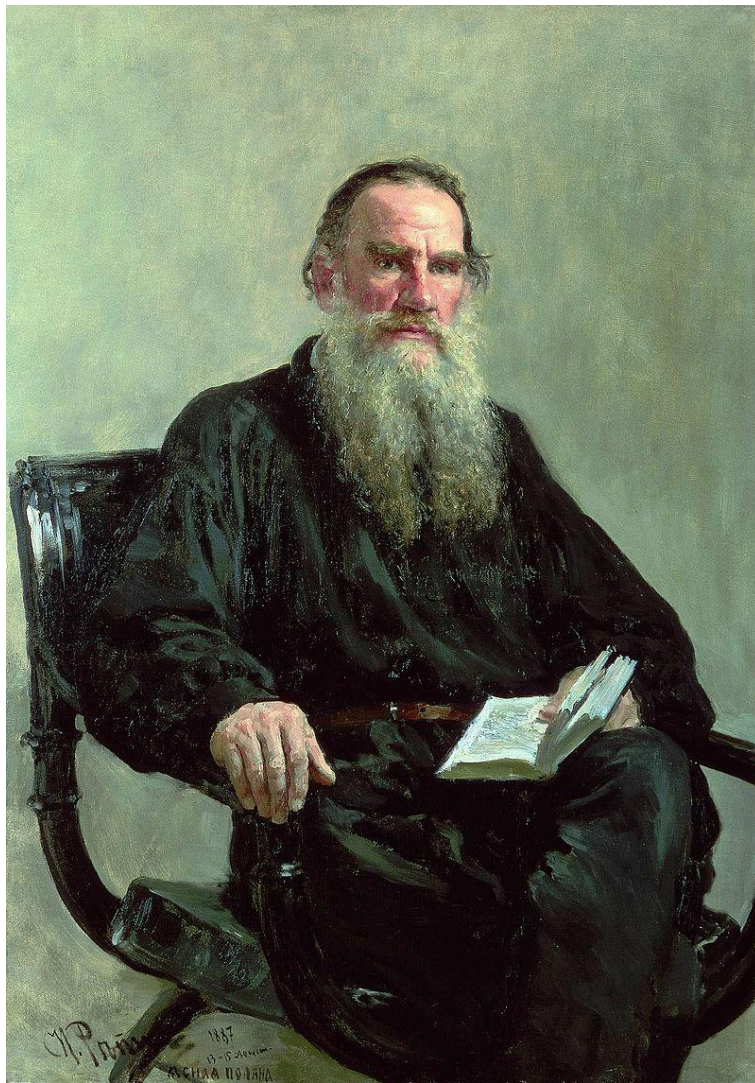

Figure 14.17: Count Leo Tolstoy



Figure 14.18: Mahatma Gandhi firmly rejected the pernicious doctrine that “the end justifies the means”. Gandhi said: “They say ‘means are after all means’. I would say ‘means are after all everything’. As the means so the end..... There is no wall of separation between means and end. Indeed the Creator has given us control (and that too very limited) over means, none over the end... The means may be likened to a seed, the end to a tree, and there is just the same inviolable connection between the means and the end as there is between the seed and the tree.”

Suggestions for further reading

1. Tamera Bryant, *The Life and Times of Hammurabi*, Mitchell Lane Publishers, (2005).
2. Mark Rooker, *The Ten Commandments: Ethics for the Twenty-First Century*. Nashville, Tennessee: B&H Publishing Group, (2010).
3. Hugh George Rawlinson, *A Concise History of the Indian People*, Oxford University Press, (1950).
4. Patrick Olivelle, *Life of the Buddha by Ashva-ghosha (1st ed.)*. New York: New York University Press, (2008).
5. Daniel Bonevac and Stephen Phillips, *Introduction to world philosophy*. New York: Oxford University Press, (2009).
6. Herrlee Glessner Creel, *Confucius: The man and the myth*. New York: John Day Company, (1949).
7. Max Kaltenmark, *Lao Tzu and Taoism*, (Translated by Roger Greaves), Stanford, Calif: Stanford University Press, (1969)
8. F. L. Cross, ed., *The Oxford Dictionary of the Christian Church*, Oxford University Press, (2005).
9. E. P. Sanders, *The Historical Figure of Jesus*. Penguin, (1993).
10. I. Howard Marshall, *The Gospel of Luke: A Commentary on the Greek text*, Eerdmans, (1978).
11. Klyne Snodgrass, *Stories with Intent: A Comprehensive Guide to the Parables of Jesus*, Eerdmans, (2008).
12. James W. Aageson, *Paul, the Pastoral Epistles, and the Early Church*, Hendrickson Publishers, (2008).
13. Vartan Gregorian, *Islam: A Mosaic, Not a Monolith*, Brookings Institution Press, (2003).
14. Charles Burnett, *The Coherence of the Arabic-Latin Translation Program in Toledo in the Twelfth Century*, *Science in Context*, 14, (2001).
15. Donald Campbell, *Arabian Medicine and Its Influence on the Middle Ages*. Routledge, (2001). (Reprint of the London, 1926 edition).
16. Donna Tussing Orwin, *The Cambridge Companion to Tolstoy* Cambridge University Press, (2002).
17. Alexandre Christoyannopoulos, *Christian Anarchism: A Political Commentary on the Gospel*. Exeter: Imprint Academic, (2010).
18. Anthony J. Parel, *Gandhi and Tolstoy*, in M. P. Mathai, M. S. John, Siby K. Joseph, *Meditations on Gandhi : a Ravindra Varma festschrift*, New Delhi: Concept, (2002).
19. Leo Tolstoy, *The Kingdom of God is Within You*,
<https://theanarchistlibrary.org/library/leo-tolstoy-the-kingdom-of-god-is-within-you.pdf>
20. Mohandas K. Gandhi, *The Story of My Experiment With Truth*, available on Amazon, Taschenbuch, (2006).

Chapter 15

THE HISTORY OF INTERNATIONAL LAW

“With law shall our land be built up, but with lawlessness laid waste.” Njal’s Saga, Iceland, c 1270.

15.1 What is law?

After the invention of agriculture, roughly 10,000 years ago, humans began to live in progressively larger groups, which were sometimes multi-ethnic. In order to make towns, cities and finally nations function without excessive injustice and violence, both ethical and legal systems were needed. Today, in an era of global economic interdependence, instantaneous worldwide communication and all-destroying thermonuclear weapons, we urgently need new global ethical principles and a just and enforceable system of international laws.

The principles of law, ethics, politeness and kindness function in slightly different ways, but all of these behavioral rules help human societies to function in a cohesive and trouble-free way. Law is the most coarse. The mesh is made finer by ethics, while the rules of politeness and kindness fill in the remaining gaps.

Legal systems began at a time at a time when tribal life was being replaced by life in villages, towns and cities. One of the oldest legal documents that we know of is a code of laws enacted by the Babylonian king Hammurabi in about 1754 BC. It consists of 282 laws, with scaled punishments, governing household behavior, marriage, divorce, paternity, inheritance, payments for services, and so on. An ancient 2.24 meter stele inscribed with Hammurabi’s Code can be seen in the Louvre. The laws are written in the Akkadian language, using cuneiform script.

Humanity’s great ethical systems also began during a period when the social unit was growing very quickly. It is an interesting fact that many of history’s greatest ethical teachers lived at a time when the human societies were rapidly increasing in size. One can think, for example of Moses, Confucius, Lao Tzu, Gautama Buddha, the Greek philosophers, and



Figure 15.1: A portion of Hammurabi's Code, c. 1754 BC

Jesus. Muhammad came slightly later, but he lived and taught at a time when tribal life was being replaced by city life in the Arab world. During the period when these great teachers lived, ethical systems had become necessary to over-write raw inherited human emotional behavior patterns in such a way that increasingly large societies could function in a harmonious and cooperative way, with a minimum of conflicts.

15.2 Magna Carta, 1215

2015 marks the 800th anniversary of the Magna Carta, which is considered to be the foundation of much of our modern legal system. It was drafted by the Archbishop of Canterbury to make peace between the unpopular Norman King John of England and a group of rebel barons. The document promised the protection of church rights, protection for the barons from illegal imprisonment, access to swift justice, and limitations feudal payments to the Crown. It was renewed by successive English sovereigns, and its protection against illegal imprisonment and provisions for swift justice were extended from the barons to ordinary citizens. It is considered to be the basis for British constitutional law, and in 1789, it influenced the drafting of the Constitution of the United States. Lord Denning described the Magna Carta as "the greatest constitutional document of all times: the foundation of the freedom of the individual against the arbitrary authority of the despot".



Figure 15.2: King John is forced to sign the Magna Carta



Figure 15.3: Lord Denning described the Magna Carta as “the greatest constitutional document of all times: the foundation of the freedom of the individual against the arbitrary authority of the despot”.

15.3 The English Bill of Rights, 1689

When James II was overthrown by the Glorious Revolution the Dutch stadholder William III of Orange-Nassau and his wife, Mary II of England were invited to be joint sovereigns of England. The Bill of Rights was originally part of the invitation, informing the couple regarding the limitations that would be imposed on their powers. Later the same year, it was incorporated into English law. The Bill of Rights guaranteed the supremacy of Parliament over the monarch. It forbid cruel and unusual punishments, excessive bail and excessive fines. Freedom of speech and free elections were also guaranteed, and a standing army in peacetime was forbidden without the explicit consent of Parliament. The Bill of Rights was influenced by the writings of the Liberal philosopher, John Locke (1632-1704).

15.4 The United States Constitution and Bill of Rights, 1789

The history of the Federal Constitution of the United States is an interesting one. It was preceded by the Articles of Confederation, which were written by the Second Continental Congress between 1776 and 1777, but it soon became clear that Confederation was too weak a form of union for a collection of states.

George Mason, one of the drafters of the Federal Constitution, believed that “such a government was necessary as could directly operate on individuals, and would punish those only whose guilt required it”, while another drafter, James Madison, wrote that the more he reflected on the use of force, the more he doubted “the practicality, the justice and the

efficacy of it when applied to people collectively, and not individually.”

Finally, Alexander Hamilton, in his Federalist Papers, discussed the Articles of Confederation with the following words: “To coerce the states is one of the maddest projects that was ever devised... Can any reasonable man be well disposed towards a government which makes war and carnage the only means of supporting itself, a government that can exist only by the sword? Every such war must involve the innocent with the guilty. The single consideration should be enough to dispose every peaceable citizen against such government... What is the cure for this great evil? Nothing, but to enable the... laws to operate on individuals, in the same manner as those of states do.”

In other words, the essential difference between a confederation and a federation, both of them unions of states, is that a federation has the power to make and to enforce laws that act on individuals, rather than attempting to coerce states (in Hamilton’s words, “one of the maddest projects that was ever devised.”) The fact that a confederation of states was found to be far too weak a form of union is especially interesting because our present United Nations is a confederation. We are at present attempting to coerce states with sanctions that are “applied to people collectively and not individually.” The International Criminal Court, which we will discuss below, is a development of enormous importance, because it acts on individuals, rather than attempting to coerce states.

There are many historical examples of successful federations; but in general, unions of states based on the principle of confederation have proved to be too weak. Probably our best hope for the future lies in gradually reforming and strengthening the United Nations, until it becomes a federation.

In the case of the Federal Constitution of the United States, there were Anti-Federalists who opposed its ratification because they feared that it would be too powerful. Therefore, on June 8, 1789, James Madison introduced in the House of Representatives a series of 39 amendments to the constitution, which would limit the government’s power. Of these, only amendments 3 to 12 were adopted, and these have become known collectively as the Bill of Rights.

Of the ten amendments that constitute the original Bill of Rights, we should take particular notice of the First, Fourth and Sixth, because they have been violated repeatedly and grossly by the present government of the United States.

The First Amendment requires that “Congress shall make no law respecting an establishment of religion, or prohibiting the free exercise thereof; or abridging the freedom of speech, or of the press; or the right of the people peaceably to assemble, and to petition the Government for a redress of grievances.” The right to freedom of speech and freedom of the press has been violated by the punishment of whistleblowers. The right to assemble peaceably has also been violated repeatedly and brutally by the present government’s militarized police.

The Fourth Amendment states that “The right of the people to be secure in their persons, houses, papers, and effects, against unreasonable searches and seizures, shall not be violated, and no Warrants shall issue, but upon probable cause, supported by Oath or affirmation, and particularly describing the place to be searched, and the persons or things to be seized.” It is hardly necessary to elaborate on the U.S. Government’s massive

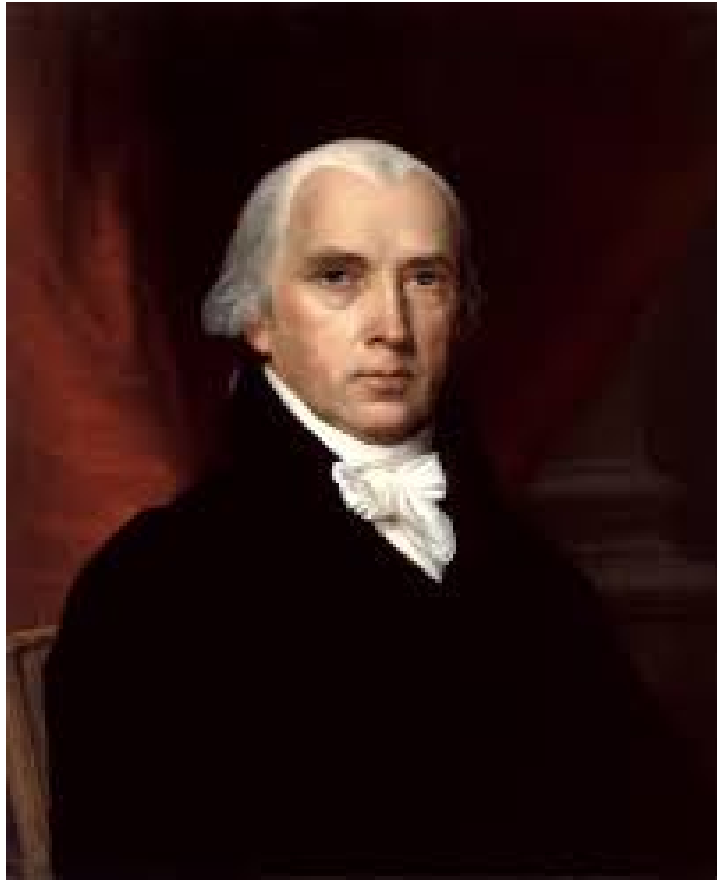

Figure 15.4: James Madison, wrote that the more he reflected on the use of force, the more he doubted “the practicality, the justice and the efficacy of it when applied to people collectively, and not individually.” He later introduced the Constitutional amendments that became the U.S. Bill of Rights.

violations of the Fourth Amendment. Edward Snowden's testimony has revealed a huge secret industry carrying out illegal and unwarranted searches and seizures of private data, not only in the United States, but also throughout the world. This data can be used to gain power over citizens and leaders through blackmail. True democracy and dissent are thereby eliminated.

The Sixth Amendment requires that "In all criminal prosecutions, the accused shall enjoy the right to a speedy and public trial, by an impartial jury of the State and district wherein the crime shall have been committed, which district shall have been previously ascertained by law, and to be informed of the nature and cause of the accusation; to be confronted with the witnesses against him; to have compulsory process for obtaining witnesses in his favor, and to have the Assistance of Counsel for his defense." This constitutional amendment has also been grossly violated.

In the context of federal unions of states, the Tenth Amendment is also interesting. This amendment states that "The powers not delegated to the United States by the Constitution, nor prohibited by it to the States, are reserved to the States respectively, or to the people." We mentioned above that historically, federations have been very successful. However, if we take the European Union as an example, it has had some problems connected with the principle of subsidiarity, according to which as few powers as possible should be decided centrally, and as many issues as possible should be decided locally. The European Union was originally designed as a free trade area, and because of its history commercial considerations have trumped environmental ones. The principle of subsidiarity has not been followed, and enlightened environmental laws of member states have been declared to be illegal by the EU because they conflicted with free trade. These are difficulties from which we can learn as we contemplate the conversion of the United Nations into a federation.

The United States Bill of Rights was influenced by John Locke and by the French philosophers of the Enlightenment. The French Declaration of the Rights of Man (August, 1789) was almost simultaneous with the U.S. Bill of Rights.

We can also see the influence of Enlightenment philosophy in the wording of the U.S. Declaration of independence (1776): "We hold these truths to be self-evident, that all men are created equal, that they are endowed by their Creator with certain unalienable Rights, that among these are Life, Liberty and the pursuit of Happiness.—That to secure these rights, Governments are instituted among Men, deriving their just powers from the consent of the governed..." Another criticism that can be leveled against the present government of the United States is that its actions seem to have nothing whatever to do with the consent of the governed, not to mention the violations of the rights to life, liberty and the pursuit of happiness implicit in extrajudicial killings.

15.5 Kellogg-Briand Pact, 1928

World War I was a catastrophe that still casts a dark shadow over the future of humanity. It produced enormous suffering, brutalization of values, irreparable cultural loss, and a

total of more than 37 million casualties, military and civilian. Far from being the “war to end war”, the conflict prepared the way for World War II, during which nuclear weapons were developed; and these now threaten the existence of human species and much of the biosphere.

After the horrors of World War I, the League of Nations was set up in the hope of ending the institution of war forever. However, many powerful nations refused to join the League, and it withered. Another attempt to outlaw war was made in 1928, in the form of a pact named after its authors, U.S. Secretary of State, Frank B. Kellogg and French Foreign Minister Aristide Briand. The Kellogg-Briand Pact is formally called the General Treaty for the Renunciation of War as an Instrument of National Policy. It was ultimately ratified by 62 Nations, including the United States (by a Senate vote of 85 to 1). Although frequently violated, the Pact remains in force today, establishing a norm which legally outlaws war.

15.6 United Nations Charter, 1945

The Second World War was even more disastrous than the First. Estimates of the total number of people who died as a result of the war range between 50 million and 80 million. With the unspeakable suffering caused by the war fresh in their minds, representatives of the victorious allied countries assembled in San Francisco to draft the charter of a global organization which they hoped would end the institution of war once and for all.

The Preamble to the United Nations Charter starts with the words: “We, the peoples of the United Nations, determined to save succeeding generations from the scourge of war, which twice in our lifetime has brought untold sorrow to mankind; and to unite our strength to maintain international peace and security; and to ensure, by the acceptance of principles and the institution of methods, that armed force shall not be used, save in the common interest; and to employ international machinery for the promotion of the economic and social advancement of all peoples, have resolved to combine our efforts to accomplish these aims.”

Article 2 of the UN Charter requires that “All members shall refrain in their international relations from the threat or use of force against the territorial integrity or political independence of any state.” This requirement is somewhat qualified by Article 51, which says that “Nothing in the present Charter shall impair the inherent right of individual or collective self-defense if an armed attack occurs against a Member of the United Nations, until the Security Council has taken measures necessary to maintain international peace and security.”

Thus, in general, war is illegal under the UN Charter. Self-defense against an armed attack is permitted, but only for a limited time, until the Security Council has had time to act. The United Nations Charter does not permit the threat or use of force in preemptive wars, or to produce regime changes, or for so-called “democratization”, or for the domination of regions that are rich in oil. ¹

¹<http://www.un.org/en/documents/charter/preamble.shtml>

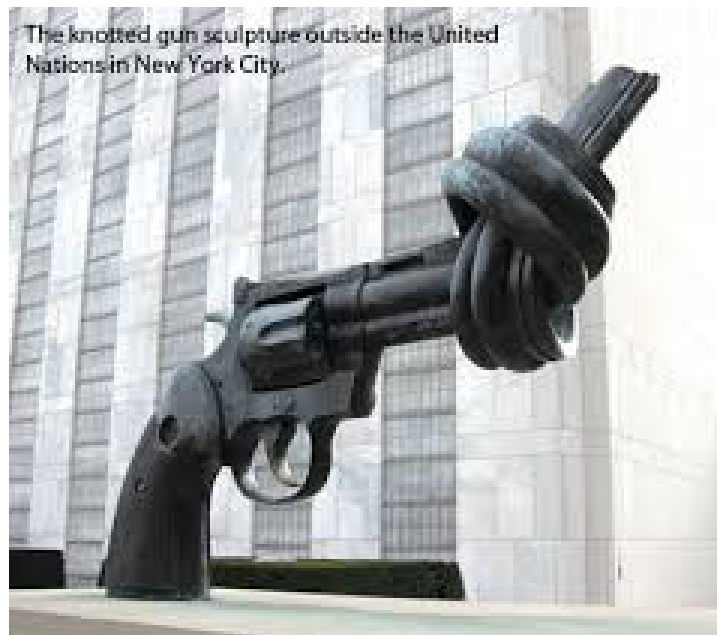

Figure 15.5: **Clearly, the United Nations Charter aims at abolishing the institution of war once and for all.**

Clearly, the United Nations Charter aims at abolishing the institution of war once and for all; but the present Charter has proved to be much too weak to accomplish this purpose, since it is a confederation of the member states rather than a federation. This does not mean that that our present United Nations is a failure. Far from it! The UN has achieved almost universal membership, which the League of Nations failed to do. The Preamble to the Charter speaks of “the promotion of the economic and social advancement of all peoples”, and UN agencies, such as the World Health Organization, the Food and Agricultural Organization and UNESCO, have worked very effectively to improve the lives of people throughout the world. Furthermore, the UN has served as a meeting place for diplomats from all countries, and many potentially serious conflicts have been resolved by informal conversations behind the scenes at the UN. Finally, although often unenforceable, resolutions of the UN General Assembly and declarations by the Secretary General have great normative value.

When we think of strengthening and reforming the UN, then besides giving it the power to make and enforce laws that are binding on individuals, we should also consider giving it an independent and reliable source of income. As it is, rich and powerful nations seek to control the UN by means of its purse strings: They give financial support only to those actions that are in their own interests.

A promising solution to this problem is the so-called “Tobin tax”, named after the Nobel-laureate economist James Tobin of Yale University. Tobin proposed that international currency exchanges should be taxed at a rate between 0.1 and 0.25 percent. He believed that even this extremely low rate of taxation would have the beneficial effect of

damping speculative transactions, thus stabilizing the rates of exchange between currencies. When asked what should be done with the proceeds of the tax, Tobin said, almost as an afterthought, "Let the United Nations have it."

The volume of money involved in international currency transactions is so enormous that even the tiny tax proposed by Tobin would provide the United Nations with between 100 billion and 300 billion dollars annually. By strengthening the activities of various UN agencies, the additional income would add to the prestige of the United Nations and thus make the organization more effective when it is called upon to resolve international political conflicts. The budgets of UN agencies, such as the World Health Organization, the Food and Agricultural Organization, UNESCO and the UN Development Programme, should not just be doubled but should be multiplied by a factor of at least fifty.

With increased budgets the UN agencies could sponsor research and other actions aimed at solving the world's most pressing problems: AIDS, drug-resistant infections diseases, tropical diseases, food insufficiencies, pollution, climate change, alternative energy strategies, population stabilization, peace education, as well as combating poverty, malnutrition, illiteracy, lack of safe water and so on. Scientists would be less tempted to find jobs with arms-related industries if offered the chance to work on idealistic projects. The United Nations could be given its own television channel, with unbiased news programs, cultural programs, and "State of the World" addresses by the UN Secretary General.

In addition, the voting system of the United Nations General Assembly needs to be reformed, and the veto power in the Security Council needs to be abolished.

15.7 International Court of Justice, 1946

The International Court of Justice (ICJ) is the judicial arm of the United Nations. It was established by the UN Charter in 1945, and it began to function in 1946. The ICJ is housed in the Peace Palace in the Hague, a beautiful building constructed with funds donated by Andrew Carnegie. Since 1946, the IJC has dealt with only 161 cases. The reason for this low number is that only disputes between nations are judged, and both the countries involved in a dispute have to agree to abide by the Court's jurisdiction before the case can be accepted.

Besides acting as an arbitrator in disputes between nations, the IJC also gives advisory opinions to the United Nations and its agencies. An extremely important judgment of this kind was given in 1996: In response to questions put to it by WHO and the UN General Assembly, the Court ruled that "the threat and use of nuclear weapons would generally be contrary to the rules of international law applicable in armed conflict, and particularly the principles and rules of humanitarian law." The only possible exception to this general rule might be "an extreme circumstance of self-defense, in which the very survival of a state would be at stake". But the Court refused to say that even in this extreme circumstance the threat or use of nuclear weapons would be legal. It left the exceptional case undecided. In addition, the World Court added unanimously that "there exists an obligation to pursue in good faith and bring to a conclusion negotiations leading to nuclear disarmament in all

its aspects under strict international control.”

This landmark decision has been criticized by the nuclear weapon states as being decided “by a narrow margin”, but the structuring of the vote made the margin seem more narrow than it actually was. Seven judges voted against Paragraph 2E of the decision (the paragraph which states that the threat or use of nuclear weapons would be generally illegal, but which mentions as a possible exception the case where a nation might be defending itself from an attack that threatened its very existence.) Seven judges voted for the paragraph, with the President of the Court, Muhammad Bedjaoui of Algeria casting the deciding vote. Thus the Court adopted it, seemingly by a narrow margin. But three of the judges who voted against 2E did so because they believed that no possible exception should be mentioned! Thus, if the vote had been slightly differently structured, the result would have been ten to four.

Of the remaining four judges who cast dissenting votes, three represented nuclear weapons states, while the fourth thought that the Court ought not to have accepted the questions from WHO and the UN. However Judge Schwebel from the United States, who voted against Paragraph 2E, nevertheless added, in a separate opinion, “It cannot be accepted that the use of nuclear weapons on a scale which would, or could, result in the deaths of many millions in indiscriminate inferno and by far-reaching fallout, have pernicious effects in space and time, and render uninhabitable much of the earth, could be lawful.”

Judge Higgins from the UK, the first woman judge in the history of the Court, had problems with the word “generally” in Paragraph 2E and therefore voted against it, but she thought that a more profound analysis might have led the Court to conclude in favor of illegality in all circumstances.

Judge Fleischhauer of Germany said, in his separate opinion, “The nuclear weapon is, in many ways, the negation of the humanitarian considerations underlying the law applicable in armed conflict and the principle of neutrality. The nuclear weapon cannot distinguish between civilian and military targets. It causes immeasurable suffering. The radiation released by it is unable to respect the territorial integrity of neutral States.”

President Bedjaoui, summarizing the majority opinion, called nuclear weapons “the ultimate evil”, and said “By its nature, the nuclear weapon, this blind weapon, destabilizes humanitarian law, the law of discrimination in the use of weapons... The ultimate aim of every action in the field of nuclear arms will always be nuclear disarmament, an aim which is no longer Utopian and which all have a duty to pursue more actively than ever.”

15.8 Nuremberg Principles, 1947

In 1946, the United Nations General Assembly unanimously affirmed “the principles of international law recognized by the Charter of the Nuremberg Tribunal and the judgment of the Tribunal”. The General Assembly also established an International Law Commission to formalize the Nuremberg Principles. The result was a list that included Principles VI, which is particularly important in the context of the illegality of NATO:

Principle VI: The crimes hereinafter set out are punishable as crimes under international



Figure 15.6: In 1946, the United Nations General Assembly unanimously affirmed “the principles of international law recognized by the Charter of the Nuremberg Tribunal and the judgment of the Tribunal”. The General Assembly also established an International Law Commission to formalize the Nuremberg Principles.

law:

a) Crimes against peace: (I) Planning, preparation, initiation or waging of a war of aggression or a war in violation of international treaties, agreements or assurances; (II) Participation in a common plan or conspiracy for accomplishment of any of the acts mentioned under (I).

Robert H. Jackson, who was the chief United States prosecutor at the Nuremberg trials, said that “To initiate a war of aggression is therefore not only an international crime; it is the supreme international crime, differing from other war crimes in that it contains within itself the accumulated evil of the whole.” Furthermore, the Nuremberg principles state that “The fact that a person acted pursuant to order of his Government or of a superior does not relieve him from responsibility under international law, provided a moral choice was in fact possible to him.” The training of soldiers is designed to make the trainees into automatons, who have surrendered all powers of moral judgment to their superiors. The Nuremberg Principles put the the burden of moral responsibility squarely back where it ought to be: on the shoulders of the individual.

15.9 The Universal Declaration of Human Rights, 1948

On December 10, 1948, the General Assembly of the United Nations adopted a Universal Declaration of Human Rights. 48 nations voted for adoption, while 8 nations abstained from voting. Not a single state voted against the Declaration. In addition, the Gen-

eral Assembly decided to continue work on the problem of implementing the Declaration. The Preamble to the document stated that it was intended “as a common standard of achievement for all peoples and nations, to the end that every individual and every organ of society, keeping this Declaration constantly in mind, shall strive by teaching and education to promote respect for these rights and freedoms.”

Articles 1 and 2 of the Declaration state that “all human beings are born free and equal in dignity and in rights”, and that everyone is entitled to the rights and freedoms mentioned in the Declaration without distinctions of any kind. Neither race color, sex, language, religion, political or other opinion, national or social origin, property or social origin must make a difference. The Declaration states that everyone has a right to life, liberty and security of person and property. Slavery and the slave trade are prohibited, as well as torture and cruel, inhuman or degrading punishments. All people must be equal before the law, and no person must be subject to arbitrary arrest, detention or exile. In criminal proceedings an accused person must be presumed innocent until proven guilty by an impartial public hearing where all necessary provisions have been made for the defense of the accused.

No one shall be subjected to interference with his privacy, family, home or correspondence. Attacks on an individual’s honor are also forbidden. Everyone has the right of freedom of movement and residence within the borders of a state, the right to leave any country, including his own, as well as the right to return to his own country. Every person has the right to a nationality and cannot be arbitrarily deprived of his or her nationality.

All people of full age have a right to marry and to establish a family. Men and women have equal rights within a marriage and at its dissolution, if this takes place. Marriage must require the full consent of both parties.

The Declaration also guarantees freedom of religion, of conscience, and of opinion and expression, as well as freedom of peaceful assembly and association. Everyone is entitled to participate in his or her own government, either directly or through democratically chosen representatives. Governments must be based on the will of the people, expressed in periodic and genuine elections with universal and equal suffrage. Voting must be secret.

Everyone has the right to the economic, social and cultural conditions needed for dignity and free development of personality. The right to work is affirmed. The job shall be of a person’s own choosing, with favorable conditions of work, and remuneration consistent with human dignity, supplemented if necessary with social support. All workers have the right to form and to join trade unions.

Article 25 of the Declaration states that everyone has the right to an adequate standard of living, including food, clothing, housing and medical care, together with social services. All people have the right to security in the event of unemployment, sickness, disability, widowhood or old age. Expectant mothers are promised special care and assistance, and children, whether born in or out of wedlock, shall enjoy the same social protection. Everyone has the right to education, which shall be free in the elementary stages. Higher education shall be accessible to all on the basis of merit. Education must be directed towards the full development of the human personality and to strengthening respect for human rights and fundamental freedoms. Education must promote understanding, toler-

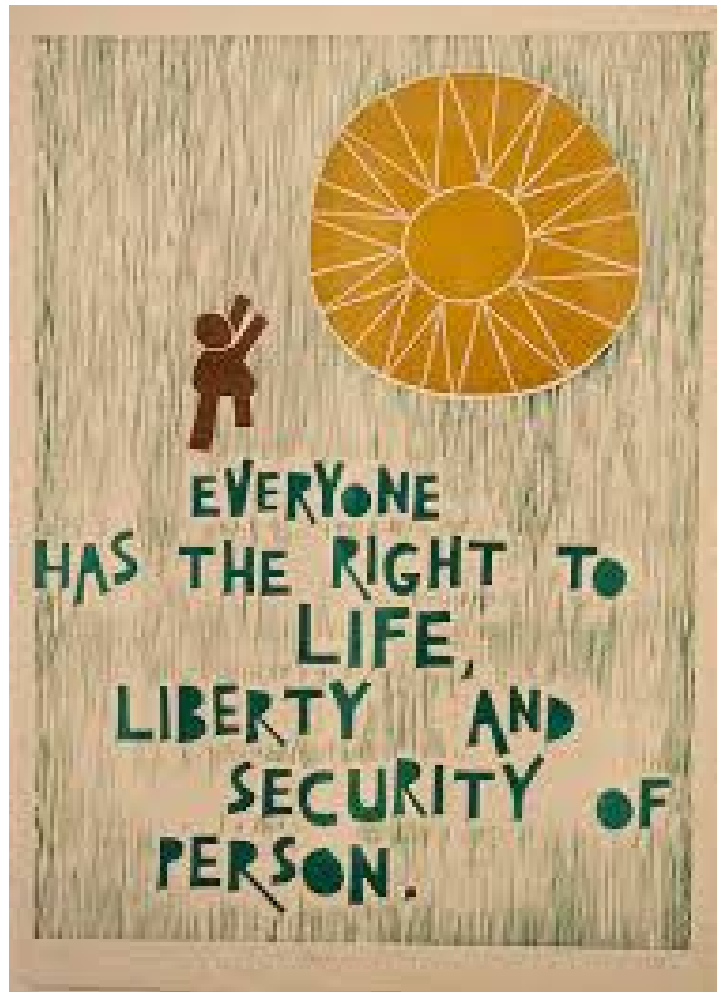

Figure 15.7: The Universal Declaration of Human Rights has great value in defining the norms towards which the world ought to be striving.

ance, and friendship among all nations, racial and religious groups, and it must further the activities of the United Nations for the maintenance of peace.

A supplementary document, the Convention on the Rights of the Child, was adopted by the United Nations General Assembly on the 12th of December, 1989. Furthermore, in July 2010, the General Assembly passed a resolution affirming that everyone has the right to clean drinking water and proper sanitation.

Many provisions of the Universal Declaration of Human Rights, for example Article 25, might be accused of being wishful thinking. In fact, Jean Kirkpatrick, former US Ambassador to the UN, cynically called the Declaration “a letter to Santa Claus”. Nevertheless, like the Millennium Development Goals, the Universal Declaration of Human Rights has great value in defining the norms towards which the world ought to be striving.

It is easy to find many examples of gross violations of basic human rights that have taken place in recent years. Apart from human rights violations connected with interventions of

powerful industrial states in the internal affairs of third world countries, there are many cases where governmental forces in the less developed countries have violated the human rights of their own citizens. Often minority groups have been killed or driven off their land by those who coveted the land, as was the case in Guatemala in 1979, when 1.5 million poor Indian farmers were forced to abandon their villages and farms and to flee to the mountains of Mexico in order to escape murderous attacks by government soldiers. The blockade of Gaza and extrajudicial killing by governments must also be regarded as blatant human rights violations, and there are many recent examples of genocide.

Wars in general, and in particular, the use of nuclear weapons, must be regarded as gross violations of human rights. The most basic human right is the right to life; but this is right routinely violated in wars. Most of the victims of recent wars have been civilians, very often children and women. The use of nuclear weapons must be regarded as a form of genocide, since they kill people indiscriminately, babies, children, young adults in their prime, and old people, without any regard for guilt or innocence.

15.10 Geneva Conventions, 1949

According to Wikipedia, “The Geneva Conventions comprise four treaties, and three additional protocols, that establish the standards of international law for the humanitarian treatment of war. The singular term, Geneva Convention, usually denotes the agreements of 1949, negotiated in the aftermath of the Second World War (1939-1945), which updated the terms of the first three treaties (1864, 1906, 1929) and added a fourth. The Geneva Conventions extensively defined the basic rights of wartime prisoners (civilians and military personnel); established protection for the wounded; and established protections for civilians in and around a war-zone. The treaties of 1949 were ratified, in whole or with reservations, by 196 countries.”

In a way, one might say that the Geneva Conventions are an admission of defeat by the international community. We tried to abolish war entirely through the UN Charter, but failed because the Charter was too weak.

Under the Fourth Geneva Convention, collective punishment is war crime. Article 33 states that “No protected person may be punished for an offense that he or she did not personally commit.” Articles 47-78 also impose substantial obligations on occupying powers, with numerous provisions for the general welfare of the inhabitants of an occupied territory. Thus Israel violated the Geneva Conventions by its collective punishment of the civilian population of Gaza in retaliation for largely ineffective Hamas rocket attacks. The larger issue, however, is the urgent need for lifting of Israel’s brutal blockade of Gaza, which has created what Noam Chomsky calls the “the world’s largest open-air prison”. This blockade violates the Geneva conventions because Israel, as an occupying power, has the duty of providing for the welfare of the people of Gaza.

15.11 Nuclear Non-Proliferation Treaty, 1968

In the 1960's, negotiations were started between countries that possessed nuclear weapons, and others that did not possess them, to establish a treaty that would prevent the spread of these highly dangerous weapons, but which would at the same time encourage cooperation in the peaceful uses of nuclear energy. The resulting treaty has the formal title Treaty on the Non-Proliferation of Nuclear Weapons (abbreviated as the NPT). The treaty also aimed at achieving general and complete disarmament. It was opened for signature in 1968, and it entered into force on the 11th of May, 1970.

190 parties have joined the NPT, and more countries have ratified it than any other arms limitation agreement, an indication of the Treaty's great importance. Four countries outside the NPT have nuclear weapons: India, Pakistan, North Korea and Israel. North Korea had originally joined the NPT, but it withdrew in 2003. The NPT has three main parts or "pillars", 1) non-proliferation, 2) disarmament, and 3) the right to peaceful use of nuclear technology. The central bargain of the Treaty is that "the NPT non-nuclear weapon states agree never to acquire nuclear weapons and the NPT nuclear weapon states agree to share the benefits of peaceful use of nuclear technology and to pursue nuclear disarmament aimed at the ultimate elimination of their nuclear arsenals".

Articles I and II of the NPT forbid states that have nuclear weapons to help other nations to acquire them. These Articles were violated, for example, by France, which helped Israel to acquire nuclear weapons, and by China, which helped Pakistan to do the same. They are also violated by the "nuclear sharing" agreements, through which US tactical nuclear weapons will be transferred to several countries in Europe in a crisis situation. It is sometimes argued that in the event of a crisis, the NPT would no longer be valid, but there is nothing in the NPT itself that indicates that it would not hold in all situations.

The most blatantly violated provision of the NPT is Article VI. It requires the member states to pursue "negotiations in good faith on effective measures relating to cessation of the nuclear arms race at an early date and to nuclear disarmament", and negotiations towards a "Treaty on general and complete disarmament". In other words, the states that possess nuclear weapons agreed to get rid of them. However, during the 47 years that have passed since the NPT went into force, the nuclear weapon states have shown absolutely no sign of complying with Article VI. There is a danger that the NPT will break down entirely because of the majority of countries in the world are so dissatisfied with this long-continued non-compliance. Looking at the NPT with the benefit of hindsight, we can see the third "pillar", the "right to peaceful use of nuclear technology" as a fatal flaw of the treaty. In practice, it has meant encouragement of nuclear power generation, with all the many dangers that go with it.

The enrichment of uranium is linked to reactor use. Many reactors of modern design make use of low enriched uranium as a fuel. Nations operating such a reactor may claim that they need a program for uranium enrichment in order to produce fuel rods. However, by operating their ultracentrifuge a little longer, they can easily produce highly enriched (weapons-usable) uranium.

The difficulty of distinguishing between a civilian nuclear power generation program

and a military nuclear program is illustrated by the case of Iran. In discussing Iran, it should be mentioned that Iran is fully in compliance with the NPT. It is very strange to see states that are long-time blatant violators of the NPT threaten Iran because of a nuclear program that fully complies with the Treaty. I believe that civilian nuclear power generation is always a mistake because of the many dangers that it entails, and because of the problem of disposing of nuclear waste. However, a military attack on Iran would be both criminal and insane. Why criminal? Because such an attack would violate the UN Charter and the Nuremberg Principles. Why insane? Because it would initiate a conflict that might escalate uncontrollably into World War III.

15.12 Biological Weapons Convention, 1972

During World War II, British and American scientists investigated the possibility of using smallpox as a biological weapon. However, it was never used, and in 1969 President Nixon officially ended the American biological weapons program, bowing to the pressure of outraged public opinion. In 1972, the United States, the United Kingdom and the Soviet Union signed a Convention on the Prohibition of the Development, Production and Stockpiling of Bacteriological (Biological) and Toxin Weapons and on their Destruction. Usually this treaty is known as the Biological Weapons Convention (BWC), and it has now been signed by virtually all of the countries of the world.

However, consider the case of smallpox: A World Health Organization team led by D.A. Henderson devised a strategy in which cases of smallpox were isolated and all their contacts vaccinated, so that the disease had no way of reaching new victims. Descriptions of the disease were circulated, and rewards offered for reporting cases. The strategy proved to be successful, and finally, in 1977, the last natural case of smallpox was isolated in Somalia. After a two-year waiting period, during which no new cases were reported, WHO announced in 1979 that smallpox, one of the most frightful diseases of humankind, had been totally eliminated from the world. This was the first instance of the complete eradication of a disease, and it was a demonstration of what could be achieved by the enlightened use of science combined with international cooperation. The eradication of smallpox was a milestone in human history.

It seems that our species is not really completely wise and rational; we do not really deserve to be called “Homo sapiens”. Stone-age emotions and stone-age politics are alas still with us. Samples of smallpox virus were taken to “carefully controlled” laboratories in the United States and the Soviet Union. Why? Probably because these two Cold War opponents did not trust each other, although both had signed the Biological Weapons Convention. Each feared that the other side might intend to use smallpox as a biological weapon. There were also rumors that unofficial samples of the virus had been saved by a number of other countries, including North Korea, Iraq, China, Cuba, India, Iran, Israel, Pakistan and Yugoslavia.

15.13 Chemical Weapons Convention, 1997

On the 3rd of September, 1992, the Conference on Disarmament in Geneva adopted a Convention on the Prohibition of Development, Production, Stockpiling, and Use of Chemical Weapons and on their Destruction. This agreement, which is usually called the Chemical Weapons Convention (CWC), attempted to remedy some of the shortcomings of the Geneva Protocol of 1925. The CWC went into force in 1997, after Hungary deposited the 65th instrument of ratification.

The provisions of Article I of the CWC are as follows: 1. Each State Party to this convention undertakes never under any circumstances: (a) To develop, produce, otherwise acquire, stockpile or retain chemical weapons, or transfer, directly or indirectly, chemical weapons to anyone; (b) To use chemical weapons; (c) To engage in any military preparation to use chemical weapons; (d) To assist, encourage or induce, in any way, anyone to engage in any activity prohibited to a State Party in accordance with the provisions of this Convention. 2. Each State Party undertakes to destroy chemical weapons it owns or possesses, or that are located any place under its jurisdiction or control, in accordance with the provisions of this Convention. 3. Each State Party undertakes to destroy all chemical weapons it abandoned on the territory of another State Party, in accordance with the provisions of this Convention. 4. Each State Party undertakes to destroy any chemical weapons production facilities it owns or possesses, or that are located in any place under its jurisdiction or control, in accordance with the provisions of this Convention. 5. Each State Party undertakes not to use riot control agents as a method of warfare.

The CWC also makes provision for verification by teams of inspectors, and by 2004, 1,600 such inspections had been carried out in 59 countries. It also established an Organization for the Prevention of Chemical Warfare. All of the declared chemical weapons production facilities have now been inactivated, and all declared chemical weapons have been inventoried. However of the world's declared stockpile of chemical warfare agents (70,000 metric tons), only 12 percent have been destroyed. One hopes that in the future the CWC will be ratified by all the nations of the world and that the destruction of stockpiled chemical warfare agents will become complete.

15.14 Mine Ban Treaty, 1999

In 1991, six NGOs organized the International Campaign to Ban Landmines, and in 1996, the Canadian government launched the Ottawa process to ban landmines by hosting a meeting among like-minded anti-landmine states. A year later, in 1997, the Mine Ban Treaty was adopted and opened for signatures. In the same year, Jody Williams and the International Campaign to ban Landmines were jointly awarded the Nobel Peace Prize. After the 40th ratification of the Mine Ban Treaty in 1998, the treaty became binding international law on the 1st of March, 1999. The Ottawa Treaty functions imperfectly because of the opposition of several militarily powerful nations, but nevertheless it establishes a valuable norm, and it represents an important forward step in the development of

international law.

15.15 International Criminal Court, 2002

In 1998, in Rome, representatives of 120 countries signed a statute establishing an International Criminal Court (ICC), with jurisdiction over the crime of genocide, crimes against humanity, war crimes and the crime of aggression.

Four years were to pass before the necessary ratifications were gathered, but by Thursday, April 11, 2002, 66 nations had ratified the Rome agreement, 6 more than the 60 needed to make the court permanent. It would be impossible to overstate the importance of the ICC. At last, international law acting on individuals has become a reality! The only effective and just way that international laws can act is to make individuals responsible and punishable, since (in the words of Alexander Hamilton) “To coerce states is one of the maddest projects that was ever devised.”

At present, the ICC functions very imperfectly because of the bitter opposition of several powerful countries, notable the United States. U.S. President George W. Bush signed into law the American Servicemembers Protection Act of 2002, which is intended to intimidate countries that ratify the treaty for the ICC. The new law authorizes the use of military force to liberate any American or citizen of a U.S.-allied country being held by the court, which is located in The Hague. This provision, dubbed the “Hague invasion clause,” has caused a strong reaction from U.S. allies around the world, particularly in the Netherlands.²

Despite the fact that the ICC now functions so imperfectly, it is a great step forward in the development of international law. It is there and functioning. We have the opportunity to make it progressively more impartial and to expand its powers.

15.16 Arms Trade Treaty, 2013

On April 2, 2013, a historic victory was won at the United Nations, and the world achieved its first treaty limiting international trade in arms. Work towards the Arms Trade Treaty (ATT) began in the Conference on Disarmament in Geneva, which requires a consensus for the adoption of any measure. Over the years, the consensus requirement has meant that no real progress in arms control measures has been made in Geneva, since a consensus among 193 nations is impossible to achieve.

To get around the blockade, British U.N. Ambassador Mark Lyall Grant sent the draft treaty to Secretary-General Ban Ki-moon and asked him on behalf of Mexico, Australia and a number of others to put the ATT to a swift vote in the General Assembly, and on Tuesday, April 3, 2013, it was adopted by a massive majority. Among the people who have worked hardest for the ATT is Anna Macdonald, Head of Arms Control at Oxfam. The reason why Oxfam works so hard on this issue is that trade in small arms is a major cause of poverty and famine in the developing countries. On April 9, Anna Macdonald wrote:

²<http://www.hrw.org/news/2002/08/03/us-hague-invasion-act-becomes-law>

“Thanks to the democratic process, international law will for the first time regulate the 70 billion dollar global arms trade. Had the process been launched in the consensus-bound Conference on Disarmament in Geneva, currently in its 12th year of meeting without even being able to agree on an agenda, chances are it would never have left the starting blocks...”

The passage of the Arms Trade Treaty by a majority vote in the UN General Assembly opened new possibilities for progress on other seemingly-intractable issues. In particular, it gave hope that a Nuclear Weapons Convention might be adopted by a direct vote on the floor of the General Assembly. The adoption of the NWC, even if achieved against the bitter opposition of the nuclear weapon states, would make it clear that the world’s peoples consider the threat of an all-destroying nuclear war to be completely unacceptable.

15.17 Racism, Colonialism and Exceptionalism

A just system of laws must apply equally and without exception to everyone. If a person, or, in the case of international law, a nation, claims to be outside the law, or above the law, then there is something fundamentally wrong. For example, when U.S. President Obama said in a 2013 speech, “What makes America different, what makes us exceptional, is that we are dedicated to act”, then thoughtful people could immediately see that something was terribly wrong with the system. If we look closely, we find that there is a link between racism, colonialism and exceptionalism. The racist and colonialist concept of “the white man’s burden” is linked to the Neo-Conservative self-image of benevolent (and violent) interference in the internal affairs of other countries. ³

15.18 The Oslo Principles on Climate Change Obligation, 2015

The future of human civilization and the biosphere is not only threatened by thermonuclear war: It is also threatened by catastrophic climate change. If prompt action is not taken to curb the use of fossil fuels: if the presently known reserves of fossil fuels are not left in the ground, then there is a great danger that we will pass a tipping point beyond which human efforts to stop a catastrophic increase in global temperatures will be useless because feedback loops will have taken over. There is a danger of a human-initiated 6th geological extinction event, comparable with the Permian-Triassic event, during which 96 percent of marine species and 70 percent of terrestrial vertebrates became extinct.

Recently there have been a number of initiatives which aim at making the human obligation to avert threatened environmental mega-catastrophes a part of international law. One of these initiatives can be seen in the proposal of the Oslo Principles on Climate Change Obligations; another is the Universal Declaration of the Rights of Mother Earth; and a

³<http://www.countercurrents.org/avery101013.htm>
<https://www.youtube.com/watch?v=efI6T8lovqY>
<https://www.youtube.com/watch?v=IdBDRbjx9jo>

third can be found in the concept of Biocultural Rights. These are extremely important and hopeful initiatives, and they point to towards the future development of international law for which we must strive.

15.19 Treaty on the Prohibition of Nuclear Weapons, 2017

A Treaty banning nuclear weapons was adopted by a majority vote on the floor of the UN General Assembly, following the precedent set by the Arms Trade Treaty. The Treaty on the Prohibition of Nuclear Weapons was passed on 7 July, 2017. It prohibits the development, testing, production, stockpiling, stationing, transfer, use and threat of use of nuclear weapons, as well as assistance and encouragement to the prohibited activities. For nuclear armed states joining the treaty, it provides for a time-bound framework for negotiations leading to the verified and irreversible elimination of its nuclear weapons programme. The International Campaign to Abolish Nuclear Weapons (ICAN) campaigned vigorously for the adoption of the Treaty, and was awarded the 2017 Nobel Peace Prize for its efforts. Although bitterly opposed by nuclear weapons states, the Treaty has great normative value, and one fervently hopes that the force of public opinion will eventually force all governments to give their citizens what the vast majority long for: a nuclear-weapon-free world.

It is generally agreed that a full-scale nuclear war would have disastrous effects, not only on belligerent nations but also on neutral countries. Mr. Javier Pérez de Cuéllar, former Secretary-General of the United Nations, emphasized this point in one of his speeches:

“I feel”, he said, “That the question may justifiably be put to the leading nuclear powers: by what right do they decide the fate of humanity? From Scandinavia to Latin America, from Europe and Africa to the Far East, the destiny of every man and woman is affected by their actions. No one can expect to escape from the catastrophic consequences of a nuclear war on the fragile structure of this planet...”

“Like supreme arbiters, with our disputes of the moment, we threaten to cut off the future and to extinguish the lives of innocent millions yet unborn. There can be no greater arrogance. At the same time, the lives of all those who lived before us may be rendered meaningless; for we have the power to dissolve in a conflict of hours or minutes the entire work of civilization, with the brilliant cultural heritage of humankind.”

15.20 Hope for the future, and responsibility for the future

Can we abolish the institution of war? Can we hope and work for a time when the terrible suffering inflicted by wars will exist only as a dark memory fading into the past? I believe that this is really possible. The problem of achieving internal peace over a large

geographical area is not insoluble. It has already been solved. There exist today many nations or regions within each of which there is internal peace, and some of these are so large that they are almost worlds in themselves. One thinks of China, India, Brazil, the Russian Federation, the United States, and the European Union. Many of these enormous societies contain a variety of ethnic groups, a variety of religions and a variety of languages, as well as striking contrasts between wealth and poverty. If these great land areas have been forged into peaceful and cooperative societies, cannot the same methods of government be applied globally?

Today, there is a pressing need to enlarge the size of the political unit from the nation-state to the entire world. The need to do so results from the terrible dangers of modern weapons and from global economic interdependence. The progress of science has created this need, but science has also given us the means to enlarge the political unit: Our almost miraculous modern communications media, if properly used, have the power to weld all of humankind into a single supportive and cooperative society.

We live at a critical time for human civilization, a time of crisis. Each of us must accept his or her individual responsibility for solving the problems that are facing the world today. We cannot leave this to the politicians. That is what we have been doing until now, and the results have been disastrous. Nor can we trust the mass media to give us adequate public discussion of the challenges that we are facing. We have a responsibility towards future generations to take matters into our own hands, to join hands and make our own alternative media, to work actively and fearlessly for better government and for a better society.

We, the people of the world, not only have the facts on our side; we also have numbers on our side. The vast majority of the world's peoples long for peace. The vast majority long for abolition of nuclear weapons, and for a world of kindness and cooperation, a world of respect for the environment. No one can make these changes alone, but together we can do it.

Together, we have the power to choose a future where international anarchy, chronic war and institutionalized injustice will be replaced by democratic and humane global governance, a future where the madness and immorality of war will be replaced by the rule of law.

We need a sense of the unity of all mankind to save the future, a new global ethic for a united world. We need politeness and kindness to save the future, politeness and kindness not only within nations but also between nations. To save the future, we need a just and democratic system of international law; for with law shall our land be built up, but with lawlessness laid waste.

Chapter 16

CONCLUSIONS

According to the currently accepted model (often called the Big Bang) our observable universe began 13.8 billion years ago as an immensely hot and dense entity, which rapidly expanded. It did not expand into empty space. Space itself expanded. This expansion was accompanied by cooling, and as the cooling and expansion continued, familiar elementary particles, such as neutrons, protons and electrons, began to appear. Then came a stage when our universe consisted of almost unimaginably enormous quantities of hydrogen and helium. Later epochs saw the formation of stars and galaxies. Within the interiors of the first stars, heavier elements were built up in nuclear reactions. Our own star, the sun, was formed from the debris left by the explosion of earlier stars, and thus the heavy elements were present in the cosmic dust which swirled around the newly-formed sun, and from this the sun's planets were formed. This model is supported by a great deal of experimental evidence. Competing models exist, but they are more speculative.

16.1 Why the earth is important

Is the earth important? Is the human species important? Are the plants and animals with which we share the gift of life important?

According to our modern understanding, the known universe is almost unimaginably enormous. It is estimated that there are roughly 1,000,000,000,000,000,000 stars in the observable universe. Of these, many stars have planets on which life is likely to have developed. Thus our earth and its life forms are by no means unique.

We cannot claim to be “the center of the universe” with any unique justification. However, the earth is our home. It is important to us. As parents, we wish for and work for the survival of our children and grandchildren, and for all future generations of humans. We must also recognize our responsibility as custodians of the natural world. We have a duty to protect both human civilization and the biosphere. We must work with dedication to guard and protect the future of our precious and beautiful earthly home.

16.2 Cultural evolution

When humans first appeared on earth, they were not very numerous, and not conspicuously different from other animals. Then suddenly, in a brief space of geological time, they exploded in numbers, populating all parts of the world, and even setting foot on the moon. This explosive growth was driven by what might be called an “information explosion”.

All animals and plants pass on information from one generation to the next in the form of DNA, the information-bearing genetic material. Occasionally, mutations occur, and favorable mutations are preserved while the bearers unfavorable mutations die out. Evolution by this genetic mechanism proceeds very slowly. Humans too, evolve by this slow genetic method, but in addition, they have another method of passing information between generations: cultural evolution.

Cultural evolution depends on the non-genetic storage, transmission, diffusion and utilization of information. The development of human speech, the invention of writing, the development of paper and printing, and finally in modern times, mass media, computers and the Internet - all these have been crucial steps in society’s explosive accumulation of information and knowledge. Human cultural evolution proceeds at a constantly-accelerating speed, so great in fact that it threatens to shake society to pieces.

Every species changes gradually through genetic evolution; but with humans, cultural evolution has rushed ahead with such a speed that it has completely outstripped the slow rate of genetic change. Genetically, we are quite similar to our neolithic ancestors, but their world has been replaced by a world of quantum theory, relativity, supercomputers, antibiotics, genetic engineering and space telescopes; unfortunately, by a world of nuclear weapons and nerve gas too.

Because of the slowness of genetic evolution in comparison to the rapid and constantly-accelerating rate of cultural change, our bodies and emotions (as Malthus put it, the “passions of mankind”) are not completely adapted to our new way of life. They still reflect the way of life of our hunter-gatherer ancestors.

Within rapidly-moving cultural evolution, we can observe that technical change now moves with such astonishing rapidity that neither social institutions, nor political structures, nor education, nor public opinion can keep pace. The lightning-like pace of technical progress has made many of our ideas and institutions obsolete. For example, the absolutely sovereign nation-state and the institution of war have both become dangerous anachronisms in an era of instantaneous communication, global interdependence and all-destroying weapons.

In many respects, human cultural evolution can be regarded as an enormous success. However, at the start of the 21st century, most thoughtful observers agree that civilization is entering a period of crisis. As all curves move exponentially upward - population, production, consumption, rates of scientific discovery, and so on - one can observe signs of increasing environmental stress, while the continued existence and spread of nuclear weapons threaten civilization with destruction. Thus, while the explosive growth of knowledge has brought many benefits, the problem of achieving a stable, peaceful and sustainable world remains serious, challenging and unsolved.

16.3 Anachronistic human emotions

Today, human greed and folly are destroying the global environment. As if this were not enough, there is a great threat to civilization and the biosphere from an all-destroying thermonuclear war. Both of these severe existential threats are due to faults our inherited emotional nature.

From the standpoint of evolutionary theory, this is a paradox. As a species, we are well on the road to committing collective suicide, driven by the flaws in human nature. But isn't natural selection supposed to produce traits that lead to survival? Today, our emotions are not leading us towards survival, but instead driving us towards extinction. What is the reason for this paradox?

Some stories from the Bible

The Old Testament is the common heritage of the three Abrahamic religions, Christianity, Judaism and Islam. Some of the stories which it contains can be seen as attempts to explain the paradoxes of human emotional nature: Why are we born with emotions that drive us to commit the seven deadly sins? Why are pride, envy, wrath, gluttony, lust, sloth and greed so much a part of human nature? The story of Adam and Eve and the Garden of Eden attempts to answer this question, as do stories about the role of Satan in the world.

According to the biblical account, Adam and Eve ate apples from the Tree of Knowledge and were therefore expelled from the Garden of Eden. This story can be seen as containing elements of historical truth. Humans were originally hunter-gatherers. Populations were so sparse that gathering roots, berries and fruits from their environment gave them enough to eat. Occasionally they obtained additional protein from the meat of animals that they were able to kill. Then agriculture was invented. Humans had eaten from the Tree of Knowledge! Populations rapidly became so dense that humans were no longer able to live simply by gathering fruit from the Garden of Eden. Expelled from the garden, they were henceforth forced to sweat for their daily bread.

What about "original sin" and the role of the Devil in the world? In the Bible, the Devil, or Satan, appears as a fallen angel who tempts humans to commit sins, i.e to break the rules of their societies. The existence of Satan is the biblical explanation of the presence of evil in the world. An alternative explanation is given by the doctrine of "original sin", which maintains that humans are born with a sinful nature.

Like the story of the Garden of Eden, these biblical concepts may also chronicle true historical events in human evolution. A sinful human is sometimes described as "behaving like an animal". In fact, what is regarded a sin in humans can be a necessary survival trait in an animal. It would be ridiculous to say "Thou shalt not steal" to a mouse or "Thou shalt not kill" to a tiger.

Our emotions have an extremely long evolutionary history. Both lust and rage are emotions that we share with many animals. However, with the rapid advance of human cultural evolution, our ancestors began to live together in progressively larger groups, and

in these new societies, our inherited emotional nature was often inappropriate. What once was a survival trait became a sin which needed to be suppressed by morality and law.

Today we live in a world that is entirely different from the one into which our species was born. We face the problems of the 21st century: exploding populations, vanishing resources, and the twin threats of catastrophic climate change and thermonuclear war. We face these severe problems with our poor cave-man's brain, with an emotional nature that has not changed much since our ancestors lived in small tribes, competing for territory on the grasslands of Africa.

16.4 Ethics can overwrite tribalism!

After the invention of agriculture, roughly 10,000 years ago, humans began to live in progressively larger groups, which were sometimes multi-ethnic. In order to make towns, cities and finally nations function without excessive injustice and violence, both ethical and legal systems were needed. Today, in an era of global economic interdependence, instantaneous worldwide communication and all-destroying thermonuclear weapons, we urgently need new global ethical principles and a just and enforceable system of international laws.

The very long childhood of humans allows learned behavior to overwrite instinctive behavior. A newborn antelope is able to stand on its feet and follow the herd almost immediately after birth. By contrast, a newborn human is totally helpless. With cultural evolution, the period of dependence has become progressively longer. Today, advanced education often requires humans to remain dependent on parental or state support until they are in their middle 20's!

Humans are capable of tribalistic inter-group atrocities such as genocides and wars, but they also have a genius for cooperation. Cultural evolution implies inter-group exchange of ideas and techniques. It is a cooperative enterprise in which all humans participate. It is cultural evolution that has given our special dominance. But cultural evolution depends on overwriting destructive tribalism with the principles of law, ethics and politeness. The success of human cultural evolution demonstrates that this is possible. Ethics can overwrite tribalism!

16.5 The need for international law and governance

After the horrors of World War II, the United Nations was founded to eliminate the institution of war. However, the UN Charter drafted in 1945 was far too weak to achieve this goal because it was a confederation rather than a federation. This was very similar to what happened during the early history of the United States: First a confederation was tried, but it soon proved to be too weak, and it was replaced by the present US federal constitution. The debates that occurred at that time are very relevant to UN reform today.

George Mason, one of the architects of the federal constitution of the United States, believed that “such a government was necessary as could directly operate on individuals, and would punish those only whose guilt required it”, while James Madison (another drafter of the U.S. federal constitution) remarked that the more he reflected on the use of force, the more he doubted “the practicability, the justice and the efficacy of it when applied to people collectively, and not individually”.

Finally, Alexander Hamilton, in his *Federalist Papers*, discussed the Articles of Confederation with the following words: “To coerce the states is one of the maddest projects that was ever devised... Can any reasonable man be well disposed towards a government which makes war and carnage the only means of supporting itself - a government that can exist only by the sword? Every such war must involve the innocent with the guilty. The single consideration should be enough to dispose every peaceable citizen against such a government... What is the cure for this great evil? Nothing, but to enable the... laws to operate on individuals, in the same manner as those of states do.”

In other words, the essential difference between a confederation and a federation, both of them unions of states, is that a federation has the power to make and to enforce laws that act on individuals, rather than attempting to coerce states (in Hamilton’s words, “one of the maddest projects that was ever devised.”)

Other reforms are also needed: If the UN is to become an effective World Federation, it will need a reliable source of income to make the organization less dependent on wealthy countries, which tend to give support only to those interventions of which they approve. A promising solution to this problem is the so-called “Tobin tax”, named after the Nobel-laureate economist James Tobin of Yale University. Tobin proposed that international currency exchanges should be taxed at a rate between 0.1 and 0.25 percent. He believed that even this extremely low rate of taxation would have the beneficial effect of dampening speculative transactions, thus stabilizing the rates of exchange between currencies. When asked what should be done with the proceeds of the tax, Tobin said, almost as an afterthought, “Let the United Nations have it.”

The volume of money involved in international currency transactions is so enormous that even the tiny tax proposed by Tobin would provide the United Nations with between 100 billion and 300 billion dollars annually. By strengthening the activities of various UN agencies, the additional income would add to the prestige of the United Nations and thus make the organization more effective when it is called upon to resolve international political conflicts.

The budgets of UN agencies, such as the World Health Organization, the Food and Agricultural Organization, UNESCO and the UN Development Programme, should not just be doubled but should be multiplied by a factor of at least fifty. With increased budgets the UN agencies could sponsor research and other actions aimed at solving the world’s most pressing problems - AIDS, drug-resistant infections diseases, tropical diseases, food insufficiencies, pollution, climate change, alternative energy strategies, population stabilization, peace education, as well as combating poverty, malnutrition, illiteracy, lack of safe water and so on. Scientists would be less tempted to find jobs with arms-related industries if offered the chance to work on idealistic projects. The United Nations

could be given its own television channel, with unbiased news programs, cultural programs, and “State of the World” addresses by the UN Secretary General.

In addition, the voting system of the United Nations General Assembly needs to be reformed, and the veto power in the Security Council need to be abolished (or alternatively, the Security Council could be abolished).

16.6 Ethics for the future

In the long run, because of the enormously destructive weapons, which have been produced through the misuse of science, the survival of civilization can only be ensured if we are able to abolish the institution of war. We must also stop destroying our planet through unlimited growth of industry and population.

Science and technology have shown themselves to be double-edged, capable of doing great good or of producing great harm, depending on the way in which we use the enormous power over nature, which science has given to us. For this reason, ethical thought is needed now more than ever before. The wisdom of the world’s religions, the traditional wisdom of humankind, can help us as we try to ensure that our overwhelming material progress will be beneficial rather than disastrous.

The crisis of civilization, which we face today, has been produced by the rapidity with which science and technology have developed. Our institutions and ideas adjust too slowly to the change. The great challenge which history has given to our generation is the task of building new international political structures, which will be in harmony with modern technology. We must abolish war and stabilize the global population. At the same time, we must develop a new global ethic, which will replace our narrow loyalties by loyalty to humanity as a whole.

Abolition of the institution of war will require the construction of structures of international government and law to replace our present anarchy at the global level. Today’s technology has shrunk the distances, which once separated nations; and our present system of absolutely sovereign nation-states has become both obsolete and dangerous.

Besides a humane, democratic and just framework of international law and governance, we urgently need a new global ethic, an ethic where loyalty to family, community and nation will be supplemented by a strong sense of the brotherhood of all humans, regardless of race, religion or nationality. Schiller expressed this feeling in his “Ode to Joy”, the text of Beethoven’s Ninth Symphony. Hearing Beethoven’s music and Schiller’s words, most of us experience an emotion of resonance and unity with its message: All humans are brothers and sisters - not just some - all! It is almost a national anthem of humanity. The feelings which the music and words provoke are similar to patriotism, but broader. It is this sense of a universal human family, which we need to cultivate in education, in the mass media, and in religion.

Educational reforms are urgently needed, particularly in the teaching of history. As it is taught today, history is a chronicle of power struggles and war, told from a biased national standpoint. Our own race or religion is superior; our own country is always heroic and in

the right.

We urgently need to replace this indoctrination in chauvinism by a reformed view of history, where the slow development of human culture is described, giving adequate credit to all those who have contributed. Our modern civilization is built on the achievements of ancient cultures. China, India, Mesopotamia, ancient Egypt, Greece, the Islamic world, Christian Europe, and Jewish intellectual traditions all have contributed. Potatoes, corn and squash are gifts from the American Indians. Human culture, gradually built up over thousands of years by the patient work of millions of hands and minds, should be presented to students of history as a precious heritage: far too precious to be risked in a thermonuclear war.

Tribalism, cultural evolution and ethics

Our remote ancestors, 100,000 years ago, lived in small, genetically homogeneous tribes, competing for territory on the grasslands of Africa. It was during this period that human emotions were formed. Since marriage was far more common within a tribe than outside it, the members of a tribe shared a common gene pool, and the tribe as a whole was the unit upon which the forces of natural selection acted. The tribe as a whole either survived or perished. This fact can explain the pattern of altruism and aggression that we observe in human emotional behavior. Humans show great altruism and loyalty to members of their own group, but they can show terrible aggression to outsiders if they believe that their own group is threatened by them.

Fortunately humans show a great capacity for overwriting primitive emotions with learned ethical behavior. Many of the great ethical teachers of history lived at a time when cultural evolution was changing humans from hunter-gatherers and pastoral peoples to farmers and city dwellers. To live and cooperate in larger groups, humans needed to overwrite their instinctive behavior patterns with culturally-determined behavior involving a wider range of cooperation than previously. This period of change is marked by the lives and ideas of a number of great ethical teachers: Moses, Buddha, Lao Tsu, Confucius, Socrates, Aristotle, Jesus, and Saint Paul. Muhammad lived at a slightly later period, but it was still a period of transition for the Arab peoples, a period during which their range cooperation needed to be enlarged.

Today, the world is divided into sovereign nation-states, whose leaders appeal to our primitive tribal emotions to create quasi-religious cults of nationalism. However, because of the terrible destructive power of modern weapons, which are capable of destroying human civilization and much of the biosphere, nationalism has today become a dangerous anachronism. We urgently need a higher ethic, an ethic for the future, where nationalism is replaced by loyalty to humanity as a whole. It must also be an ethic where we strongly feel a duty to protect all living creatures and the earth's environment.

The world's religions

There is a remarkable agreement on ethical principles between the major religions of the world. The central ethical principles of Christianity can be found in the Sermon on the Mount and in the Parable of the Good Samaritan. In the Sermon on the Mount, we are told that we must not only love our neighbors as much as we love ourselves; we must also love and forgive our enemies. This seemingly impractical advice is in fact of great practicality, since escalatory cycles of revenge and counter-revenge can only be ended by unilateral acts of kindness.

In the Parable of the Good Samaritan, we are told that our neighbor, whom we must love, is not necessarily a member of our own ethnic group. Our neighbor may live on the other side of the world and belong to an entirely different race or culture; but he or she still deserves our love and care.

It is an interesting fact that the Golden Rule, "Do unto others as you would have them do unto you", appears in various forms in all of the world's major religions. The Wikipedia article on the Golden Rule gives an impressive and fascinating list of the forms in which the rule appears in many cultures and religions. For example, in ancient China, both Confucius and Lao Tzu express the Golden Rule, but they do it slightly differently: Zi Gong asked, saying, "Is there one word that may serve as a rule of practice for all one's life?" The Master said, "Is not reciprocity such a word?" (Confucius) and "The sage has no interest of his own, but takes the interests of the people as his own. He is kind to the kind; he is also kind to the unkind: for Virtue is kind. He is faithful to the faithful; he is also faithful to the unfaithful: for Virtue is faithful." (Lao Tzu)

In the Jewish tradition, we have "The stranger who resides with you shall be to you as one of your citizens; you shall love him as yourself, for you were strangers in the land of Egypt" (Leviticus)

In Islam: A Bedouin came to the prophet, grabbed the stirrup of his camel and said: O the messenger of God! Teach me something to go to heaven with. The Prophet said: "As you would have people do to you, do to them; and what you dislike to be done to you, don't do to them. This maxim is enough for you; go and act in accordance with it!" (Kitab al-Kafi, vol. 2, p. 146)

These fundamental ethical principles, shared by all of the world's major religions, would be enough to make war impossible if they were only followed. But too often, religion has emphasized the differences between ethnic groups rather than appealing for comprehensive human solidarity. Too often, religion has been a source of conflict and war, rather than a force which would make war impossible. Too often, religion has been part of the problem, rather than the solution, but it could potentially be the solution. Every week, in churches, mosques, temples and synagogues, congregations listen to sermons which could potentially carry the message of peace, abolition of war, abolition of nuclear weapons and also the message of universal human brotherhood. If our religious leaders do not use this opportunity, they will be failing humanity at a time of mortal danger.

Can ethical principles be derived from science?

It is often said that ethical principles cannot be derived from science, that they must come from somewhere else. Nevertheless, when nature is viewed through the eyes of modern science, we obtain some insights which seem almost ethical in character. Biology at the molecular level has shown us the complexity and beauty of even the most humble living organisms, and the interrelatedness of all life on earth. Looking through the eyes of contemporary biochemistry, we can see that even the single cell of an amoeba is a structure of miraculous complexity and precision, worthy of our respect and wonder.

Knowledge of the second law of thermodynamics, the statistical law favoring disorder over order, reminds us that life is always balanced like a tight-rope walker over an abyss of chaos and destruction. Living organisms distill their order and complexity from the flood of thermodynamic information which reaches the earth from the sun. In this way, they create local order; but life remains a fugitive from the second law of thermodynamics. Disorder, chaos, and destruction remain statistically favored over order, construction, and complexity.

It is easier to burn down a house than to build one, easier to kill a human than to raise and educate one, easier to force a species into extinction than to replace it once it is gone, easier to burn the Great Library of Alexandria than to accumulate the knowledge that once filled it, and easier to destroy a civilization in a thermonuclear war than to rebuild it from the radioactive ashes. Knowing this, we can form an almost ethical insight: To be on the side of order, construction, and complexity, is to be on the side of life. To be on the side of destruction, disorder, chaos and war is to be against life, a traitor to life, an ally of death. Knowing the precariousness of life, knowing the statistical laws that favor disorder and chaos, we should resolve to be loyal to the principle of long continued construction upon which life depends.

War is based on destruction, destruction of living persons, destruction of homes, destruction of infrastructure, and destruction of the biosphere. If we are on the side of life, if we are not traitors to life and allies of death, we must oppose the institution of war. We must oppose the military-industrial complex. We must oppose the mass media when they whip up war-fever. We must oppose politicians who vote for obscenely enormous military budgets at a time of financial crisis. We must oppose these things by working with dedication, as though our lives depended on it. In fact, they do.

The need for a new system of economics

Our present economic system is one of the main causes of war, and one of the main reasons why we are destroying the earth's environment. We need a new economic system, which will have both a social conscience and an environmental conscience.

According to the great classical economist Adam Smith (1723-1790), self-interest (even greed) is a sufficient guide to human economic actions. The passage of time has shown that Smith was right in many respects. The free market, which he advocated, has turned out to be the optimum prescription for economic growth. However, history has also shown that

there is something horribly wrong or incomplete about the idea that individual self-interest alone, uninfluenced by ethical and ecological considerations, and totally free from governmental intervention, can be the main motivating force of a happy and just society. There has also proved to be something terribly wrong with the concept of unlimited economic growth.

During the early phases of the Industrial Revolution, the landowners of Scotland were unquestionably following self-interest as they burned the cottages of their crofters because it was more profitable to have sheep on the land; and self-interest motivated overseers as they whipped half-starved child workers in England's mills. Adam Smith's "invisible hand" no doubt guided their actions in such a way as to maximize production. But the result was a society with enormous contrasts between rich and poor, a society in which a large fraction of the population lived in conditions of gross injustice and terrible suffering. Self-interest alone was not enough.

A society following purely economic laws, a society where selfishness is exalted as the mainspring for action, lacks both the ethical and ecological dimensions that are needed for social justice, widespread happiness, and sustainability. That is true today, just as it was during the early phases of the Industrial Revolution. In fact, Adam Smith himself would have accepted this criticism of his enthronement of self-interest as the central principle of society. He believed that his "invisible hand" would not work for the betterment of society except within the context of governmental regulation. His modern Neoliberal admirers, however, forget this aspect of Smith's philosophy, and maintain that market forces alone can achieve a desirable result.

Today, in many countries, gigantic corporations control governments, and they act not only to promote "resource wars", but also to promote the unlimited economic growth that is destroying the global environment. The idea that growth can continue forever on a finite planet is an absurdity. Therefore we urgently need a new form of economics: Ecological Economics or Steady-State Economics.

When possessions are used for the purpose of social competition, demand has no natural upper limit; it is then limited only by the size of the human ego, which, as we know, is boundless. This would be all to the good if unlimited industrial growth were desirable; but today, when further industrial growth implies future collapse, western society urgently needs to find new values to replace our worship of power, our restless chase after excitement, and our admiration of excessive consumption. We must stop using material goods for the purpose of social competition.

In the world of the future, a future of changed values, women will take their places beside men in positions of responsibility, children will be educated rather than exploited, non-material human qualities, such as kindness, politeness, knowledge and musical and artistic ability will be valued more highly, and people will derive a larger part of their pleasure from conversation and from the appreciation of unspoiled nature. These are the values that we need for the future, a future that belongs not only to ourselves, but to our children and grandchildren.

In the world as it is today, 1.8 trillion dollars are wasted on armaments each year; and while this is going on, children in the developing countries sift through garbage dumps

searching for scraps of food. In today's world, the competition for jobs and for material possessions makes part of the population of the industrial countries work so hard that they damage their health and neglect their families; and while this is going on, another part of the population suffers from unemployment, becoming vulnerable to depression, mental illness, alcoholism, drug abuse and crime.

In the world of the future, which we now must build, the institution of war will be abolished, and the enormous resources now wasted on war will be used constructively. In the future world as it can be if we work to make it so, a stable population of moderate size will live without waste or luxury, but in comfort and security, free from the fear of hunger or unemployment. The world which we want will be a world of changed values, where human qualities will be valued more than material possessions. Let us try to combine wisdom and religious ethics from humanity's past with today's technology to build a sustainable, livable and equitable future world.

On our small but beautiful earth, made small by technology, made beautiful by nature, there is room for one group only: the family of humankind.

Index

- A Confession, 640
- A-lifers, 329
- Ab-initio calculations, 294
- Abbevillian, 125, 127
- Abiotic chemistry, 103
- Abolition of nuclear weapons, 528
- Abolition of the institution of war, 674
- Abolition of war, 160, 521, 528, 629, 655
- Abortion, 213
- Abrahamic religions, 624
- Abrupt climate change, 578
- Absolute monarchy, 189, 192
- Absolutely sovereign nation-states, 592, 670
- Abundances of elements, 40
- Academy, 621
- Accelerated development, 309
- Acceleration of cultural change, 479
- Accents, 483
- Accident waiting to happen, 504, 534
- Accidental nuclear war, 243, 504, 522, 528, 534, 539
- Accidents, 536
- Acid rain, 370
- Act of Valor, 518
- Action potential, 315
- Activation, 315
- Active site, 84
- Active transport, 303
- ADA programming language, 283
- Adam and Eve, 671
- Adam Smith, 678
- Adam Smith's invisible hand, 416, 678
- Adaptor molecule, 85
- Adenine, 83
- Adenosine triphosphate, 98
- Admiral Brahe, 19, 20
- Admiral von Tirpitz, 489
- Adolf Hitler, 492
- Advertisers, 244
- Advertising, 247, 261
- Africa, 164, 167, 511
- Africa, population projections, 420
- African Union, 379
- Agar-agar, 437
- Age of Discovery, 189
- Age of Reason, 186, 189, 190
- Age of the earth, 71, 95
- Age of the universe, 40
- Agenda 21, 259
- Agent Orange, 526
- Aggregate income, 268
- Aggression, 473, 475, 477
- Agricultural research, 160
- Agricultural revolution, 150
- Agricultural screw press, 186
- Agriculture, 138, 216, 305, 506, 508, 529
- Agrobacterium tumofaciens, 92
- Ahimsa, 249
- Aiken, Howard, 286, 290
- Air pollution in China, 565
- Air pressure, 204
- Air resistance, 29
- Air travel, 579
- Air travel and pandemics, 458
- Airbus, 514
- Aircraft engines, 303
- Al-Hazen, 635
- Al-Khwarizmi, 634
- Al-Qaeda, 510, 538
- Alaska, 479

- Albedo effect, 579
Albert Einstein, 31
Alcohol, 435
Algebra, 608, 634
Algeria, 576
Alhambra, 636
Alkali, 634
All humans are brothers and sisters, 674
All men are created equal, 193
All-destroying modern weapons, 603
Allowed energy bands, 295
Alma-Ata Declaration, 413
Almagest, 15
Alpha-proteobacteria, 107, 134
Alphabet, 174
Alternative ways of life, 189
Altman, Robert, 106
Altman, Sydney, 99
Altruism, 109, 477
Amazon deforestation causes, 372
Amazon rainforest, 372
Amazon rainforest dieback, 578
American Revolution, 192
American Sniper, 518
Americium, 540
Amino acid sequences, 84, 100, 310
Amino acids, 84, 86, 95, 98
Ammonia, 94, 95
An ecological conscience for economics, 677
Anachronistic human emotions, 648, 671
Anaerobic ecological niches, 134
Analytical engine, 282
Analytical machine, 282
Ancestor, 328
Ancestor worship, 483
Ancien régime, 189
Ancient fossil microorganisms, 110
Ancient rice terraces, 153
Anderson, Kevin, 587, 589
Andes mountains, 76
Andromeda spiral nebula, 36
Anaxagoras, 355
Angola, 576
Aniline dyes, 444
Animal kingdom, 69
Animals, 100
Animals with human genes, 321
Anna Karenina, 640
Annan, Kofi, 507, 539
Anne H. Ehrlich, 381
Antarctic sea ice loss, 578
Anthrax, 437
Anthropocene, 517
Anthropogenic climate change, 540
Anthropoid apes, 123
Anthropology, 190, 244, 245
Anti-communism, 242
Anti-union laws, 233
Anti-war manifesto, 32
Antibaryon constituencies, 42
Antibiotic-resistance marker, 91
Antibiotics, 670
Antibodies, 452
Anticommunist alternative, 494
Antigens, 452
Antileptons, 43
Antimalarial program, 522
Antiquarks, 43
Anton Lavoisier, 222
Antonio Guterres, 465
Ants, 122
Anxiety about the future, 524
Apollo 11 lands on the Moon, 356
Apparent brightness and period, 36
Apprentices, 212
Aquifers, 164
Aquifers overdrawn, 163
Arab nationalism and Islam, 483
Arabic, 633
Arable land, 164, 376
Arachnids, 122
Archaeobacteria, 100
Archaeoperix appears, 122
Archimedes, 633
Arctic methane release, 578
Arctic permafrost, 588

- Arctic sea ice loss, 578
 Ardipithecus ramidus, 124, 126, 128
 Are we evil?, 581
 Area of cropland, 164
 Argentina, 163
 Argon, 222
 Arid grasslands, 167
 Aridity, 163
 Aristarchus, 14, 18, 355
 Aristophanes, 623
 Aristotle, 20, 69, 204, 321, 633, 635
 Arkwright, Richard, 208, 212, 224
 Armaments (\$1.7 trillion spent on), 522
 Armaments race, 489, 491
 Arms control agreements, 517
 Arms manufacturers, 491
 Arms race, 489
 Arms Trade Treaty, 665
 Armstrong, Niel, 356
 Army training program, 519
 Arnold, Sir Edward, 248
 ARPANET, 307
 Arrhenius, Svante, 579
 Art objects, 479
 Article VI, 504, 533
 Article VI of the NPT, 662
 Articles dominated by trivia, 593
 Articles of Confederation, 650
 Artificial evolution, 322
 Artificial intelligence, 279, 309, 310
 Artificial life, 321, 326, 327
 Artificial molecular evolution, 322
 Artificial needs, 261
 Artificial neural networks, 315, 319
 Artistic creativity, 309
 As big as a house, 294
 ASCC calculator, 286, 290
 Ascidians, 69
 Asia, 535
 Asphalt melting, 572
 Assassination attempts, 538
 Asteroid belt, 57
 Asteroids, 504, 534
 Asthenosphere, 57
 Astrology, 22
 Astronautics, 349
 Astronomical unit, 57
 Astronomy, 13, 15, 22, 608, 635
 Asylum, 525
 Athens, 620
 Atmosphere, 260
 Atmospheric engine, 204
 Atmospheric pressure, 204
 Atmospheric refraction, 22
 Atom bomb, 476
 Atomic nuclei, 43
 ATP, 98, 314, 322
 Atrocities, 475
 Attack on the Amazon rainforest, 372
 Attenborough, Sir David, 582, 591
 Augmented weight vector, 318
 Augusta Ada, 283
 Aurignacian, 125, 127
 Auschwitz, 492
 Australia, 163
 Australian megafauna diversify, 123
 Australopithecines, 123
 Australopithecus, 124
 Australopithecus bosei, 126
 Australopithecus afarensis, 126
 Australopithecus ramidus, 126
 Austria-Hungary, 489
 Autoassembly, 299, 310, 311
 Autocatalysis, 98
 Autocatalytic systems, 94
 Automatic warehouses, 304
 Automation, 302, 305
 Automobiles, 244
 Autoradiography, 83
 Averrões, 69
 Averroes, 635
 Avery, O.T., 82
 Avicenna, 634
 Axons, 310, 315
 B-lifers, 329

- Babbage, Charles, 279, 281, 282
Baby-producing machines, 411
Bacterial cell wall, 84
Bacteriology, 437
Bacteriophages, 86, 90
Bacteriorhodopsin, 313
BAE Systems, 514
Baghdad, 634
Balard, Jerome, 434
Ballhausen, Carl J., 303
Bananas cultivated and hybridized, 152
Band structure of crystals, 295
Bangladesh, 160, 560
Bangladesh under water, 588
Banking, 304, 305
Barack Obama, 386
Baran, Paul, 307
Bardeen, John, 295, 296
Barnaby, Frank, 539
Barometer, 203
Baron d'Holbach, 192
Baron Stern of Brentford, 570
Barrow, Isaac, 26, 28
Bartel, D.P., 322
Baryons, 42
Base sequences, 100
Bateson, Gregory, 290, 293
Bats, 123
Battleship Potemkin, 242
Battleships, 491
Beadle, George, 85
Beagle, 73
Bears, 123
Bedjaoui, Muhammad, 503, 532
Bee populations declining, 364
Bee-keeping, 379
Beef and methane, 372
Beef Industry in South America, 372
Beef killing the rainforest, 372
Beethoven's Ninth Symphony, 674
Beetles diversify, 122
Behind Enemy Lines, 518
Belarus, 535
Bell Laboratories, 39
Bell Telephone Laboratories, 287, 289, 295
Belt of Tar, 573
Belts made from shell beads, 177
Benda, A., 106
Bending of a light ray, 33
Benedin, Edouard van, 81
Berg, Paul, 90
Bering Strait, 147, 479
Bering Strait land bridge, 155
Berkeley, California, 256
Berlin Wall, 243
Bernal, J.D., 84
Bernard Lowen, 528
Berzelius, Jons Jakob, 436
Besant, Annie, 214, 248
Bessemer steel, 241
Betrayal of Science, 382
Bhagavad Gita, 248
Bhutto, Zulfikar Ali, 538
Big Bang, 39, 669
Big coal and oil corporations, 592
Bilateral agreements, 577
Bilayer membranes, 311
Bill of Rights, 651
Billion people undernourished, 418
Binary digit, 291
Binary numbers, 287, 299
Binning, Gerd, 313
Binomial theorem, 26
Bio-information technology, 310
Biocapacity, 361
Biocultural Rights, 667
Biodiversity, 586
Biodiversity loss, 370
Biological constraints, 261
Biological diversity, 259, 260
Biological evolution, 71, 320
Biological neural networks, 315
Biological Weapons Convention, 663
Biology, 310
Biology and Society, 381
Biology of War and Peace, 480

- Biophysical capacity, 586
 Biosemiotics, 291
 Biosynthesis of hemoglobin, 85
 Biosynthesis of proteins, 85
 Biot, Jean Baptiste, 435
 Biotechnology, 260, 321
 Birmingham, 219
 Birth anomalies, 526
 Birth control, 213, 214, 227, 230, 233, 235, 243, 377
 Birth control programs, 160, 418
 Bits, 299
 Bits per unit area, 299
 Bjørnholm, Thomas, 312
 Black Hawk Down, 518, 519
 Black rat, 212
 Black, Joseph, 218, 222
 Blair, Bruce G., 504, 534
 Blake, William, 198
 Blastocysts, 92
 Blavatski, Madame, 248
 Block printing, 182
 Blood for oil, 576
 Bloodsucking insects, 122
 Bloody Sunday, 242
 Boeing, 514
 Bohr, Niels, 536
 Bohr-Wheeler theory, 536, 537
 Bolsheviks, 242
 Bolsonaro, Jair, 372, 559
 Bomb plot, 242
 Bombyx mori, 291
 Books, 178
 Boolean functionality, 319
 Boreal forest dieback, 578
 Borlaug, Norman, 160, 164
 Bosons, 42
 Bottom-up synthesis, 312
 Boulton and Watt, 221
 Boulton, Matthew, 207, 219, 220
 Bows and arrows, 138
 Boyle, Robert, 28
 Bradlaugh, Charles, 214
 Brahe, Tycho, 19, 24, 26, 186
 Brahmagupta, 608
 Brain size, 125
 Brain structure and functions, 315
 Brain, mechanism of, 309
 Bramacharya, 249
 Brattain, Walter, 295, 296
 Brazil, 164, 559
 Brazil subsidizes beef industry, 372
 Brazil's economy, 573
 Brazil's offshore oil, 573
 Brazil's presalt oil, 577
 Breivik, Anders Behring, 521
 Bremer, Sidney, 86
 Breton Woods Conference, 268
 Brexit, 517
 Britain, 489
 British Empire, 248
 British Isles, 150
 British Labour Party, 233
 British Library, 183
 British museum, 178
 British North Sea oil, 574
 British public, 251
 British raj, 251
 Broca's area, 125
 Broom, Robert, 124
 Brose Eric, 489
 Brotherhood of all humankind, 641
 Brown rat, 212
 Brown, Lester R., 269
 Brownian motion, 32
 Brundtland Report, 257
 Brundtland, Gro Harlem, 257
 Brutalization of values, 491
 Bubonic plague, 212
 Buddhism, 182, 252, 607, 616
 Buddhist monks, 182
 Buffon. Compte de, 71
 Bukht-Yishu family, 633
 Bulgaria bans fracking, 573
 Burial customs, 483
 Burks, Arthur, 323, 326

- Burnet, Sir Frank Macfarlane, 452
Burning of peatlands, 371
Bush family and Hitler, 492
Bush political dynasty, 493
Bush, George W., 492, 665
Bush, Prescott, 492
Bush, Vannevar, 287
Bush-Nazi connection, 493
Business as usual, 577
Business as usual leads to disaster, 361
Business cycle, 267
Butterflies, 123
Butyric acid, 436
Bypassing the need for grids, 566
Bytes, 299
Byzantium, 633
- César Milstein, 453
Cajal, Ramòn y, 310
Calculating box, 279
Calculations took hundreds of hours, 294
Calculus, 26, 28, 29
Caldecott, Helen, 494
Calico, 608
Call of Duty, 521
Calogero, Francesco, 505
Calvin, Melvin, 95, 98
Cambrian Explosion, 121, 329
Cambridge University, 26, 83, 84
Camel domesticated, 152
Camels, 123
Camera, 635
Canada, 163
Canadian government, 572
Canadian oil sands, 572
Cancer caused by radioactivity, 526
Cancer therapy, 457
Capitalism triumphant, 243
Carbon, 44
Carbon bubble, 560
Carbon budget, 560, 583
Carbon chuanism, 329
Carbon dioxide, 222, 361
Carbon footprint, 583
Carbon Tracker Initiative, 560
Carbon-dioxide fixation, 103
Carbon-negative world, 587
Care of the elderly, 411
Carlyle, Thomas, 213
Carmoniferous Period, 122
Carnegie Foundation, 241
Carnegie Institution, 241
Carnegie Mellon University, 241
Carnegie, Andrew, 238, 240
Carnivorous mammals diversify, 123
Carrying capacity, 163, 261
Carson, Rachel, 366
Cashmere, 608
Cassini, Giovanni, 359
Cassini-Huygens space probe, 359
Caste markings, 483
Caste system, 607
Catalysis, 436
Catastrophic climate change, 163, 559, 560, 571, 575, 579, 585, 672
Catastrophic global famine, 411
Catastrophic global war, 491
Catastrophic mistake, 504, 534
Catastrophic nuclear war, 507, 508, 527, 529
Catastrophist theories, 76
Cats, 123
Cattle domesticated, 152
Cattle ranching in Amazonia, 372
Causes of Amazon deforestation, 372
Cave paintings, 138
Cavendish, Henry, 222
Caveolae, 311
Cech, Thomas R., 99
Cell differentiation, 109
Cell lattice, 323
Cell membranes, 100
Cell-surface antigens, 133
Cells resembling prokaryotes, 121
Cellular Automaton Model, 323, 324
Center for Nonlinear Studies, 326
Central processing unit, 296

- Central processing units, 299, 315
 Centralization, 249
 Cepheid variable stars, 36
 Ceremonies, 483
 Ceres, 57
 Cerf, Vinton, 307
 Cerrado, 164
 Chad, 511
 Chadors, 483
 Chagas' disease, 78
 Chain-reacting pile, 537
 Chance favours the prepared mind, 439
 Chance of survival, 507
 Change of diet, 376
 Channel weights, 315
 Chargaff, Erwin, 83
 Charge distributions, 445
 Chastity, 249
 Chatelet, Madame du, 30, 190
 Checks to population growth, 377
 Chemical energy, 313
 Chemical evolution, 94
 Chemical industries, 304
 Chemical pesticides, 366
 Chemical properties, 536
 Chemical signals, 109
 Chemical warfare, 526
 Chemical Weapons Convention, 664
 Chemistry, 222, 302, 634
 Chemistry of gases, 222
 Chemotherapy, 444
 Chernobyl disaster, 535
 Chess-playing program, 310
 Chicken cholera, 439
 Child labor, 213, 225, 230, 233, 243
 Child labor laws, 411, 416
 Child soldiers, 524
 Children killed by wars, 502, 532
 Children killed in war, 523
 Children sift through garbage dumps, 679
 Children's rights, 412
 Chilean coast, 76
 Chimeras, 321
 Chimeric animals, 92
 Chimpanzees, 124
 China, 160, 164, 176, 178, 243, 420, 431, 513
 China's coal, 577
 China's Great Green Wall, 379
 China's palm oil demand, 372
 China's use of coal, 571
 China, air pollution, 565
 China, rapid industrial expansion, 571
 Chinese civil-service examinations, 618
 Chinese empire, 176
 Chinese invention of ink, 182
 Chinese invention of paper, 178
 Chinese invention of printing, 182
 Chinese lyric poetry, 183
 Chinese public opinion, 565
 Chinese Turkestan, 182
 Chinese written language, 182
 Chips, 298
 Chloroplasts, 106
 Cholera, 437
 Chomsky, Noam, 661
 Choukoutien, 125, 127
 Christian ethical principles, 252
 Christian ethics, 624
 Christian Europe, 178
 Christian IV, 20
 Christian IV, king of Denmark, 22
 Christianity, 624, 640
 Christianity and war, 641
 Christians must love their enemies, 629
 Chromatography, 83
 Chromosomal maps, 82
 Chromosome crossing, 320
 Chromosomes, 81, 108
 Chronology, 13
 Church-Turing hypothesis, 287
 Circumcision, 483
 Citric acid cycle, 103
 Civil disobedience, 251–253
 Civil rights, 248, 249
 Civil service examinations, 176
 Civil society, 507

- Civil wars, 511, 523
- Civilian victims of war, 502, 532
- Civilians are hostages, 521
- Civilians as targets, 507
- Civilians killed in war, 523
- Civilization coming to an end, 589
- Clark, General Wesley, 510
- Clark, W., 307
- Classical economics, 267, 268
- Classical genetics, 80
- Classification, 319
- Classification of living things, 69
- Classifier network, 319
- Clean energy, 591
- Clean water near homes, 411, 415
- Clementi, Enrico, 294, 303
- Climate action, 389
- Climate and environment, 517
- Climate change, 167, 259, 420, 536, 540, 656
- Climate change denial, 559
- Climate change mitigation urgent, 160
- Climate Change Obligation, 666
- Climate crisis, 583, 584, 590
- Climate emergency, 559, 577, 591
- Climate justice, 581
- Climate tipping points, 579
- Climatic stability, 138, 150
- Clock, 30
- Clonal theory of immunity, 452
- Cloning, 91, 321
- Cluster bombs, 526
- Coal, 540
- Coal and steel, 493
- Coal per capita, 575
- Coal produced in Germany, 574
- Coal produced in Poland, 574
- Coal producers, 575
- Coal production in India, 571
- Coal reserves in China, 571
- Codd, E.F., 324, 326
- Codons, 86
- Coercion of states, 673
- Cold War, 242, 243, 504, 511, 522, 534
- Collapse of our civilization, 582, 591
- Collective consciousness, 309
- Collective paranoia, 521
- Collective punishment, 661
- Collectives, 232
- Colombia, 576
- Colombia University, 82
- Colonial system, 250
- Colonialism, 229, 666
- Colonialism and World War I, 491
- Colors, 27
- Colossus, 287
- Comb jelles, 122
- Combustion of glucose, 134
- Comets, 57
- Comfort, equality and dignity, 160
- Commercial middle class, 189
- Common sense, 189
- Communal aggression, 475
- Communal defense response, 475, 476
- Communism, 243
- Communist Party, 494
- Competition, 235, 243, 480
- Complementarity, 86, 311, 444
- Complex systems, 327, 330
- Complexity, 235, 326
- Compromise, 248
- Compulsory education, 201
- Computer disc storage, 299
- Computer games, 519
- Computer memories, 299
- Computer networks, 299, 304
- Computer scientists, 310
- Computer software, 270
- Computer virus, 327
- Computer-assisted design, 303
- Computerization of commerce, 304
- Computers, 279
- Concepcion, 76
- Conception, 214
- Condenser, 206, 207, 219
- Conduction bands, 295, 296
- Conductor, 295

- Confirmed COVID-19 cases and deaths, 458
 Conflict-related deaths, 377
 Confucius, 604, 613, 648
 Congress Party, 249
 Congreve rockets bombard Copenhagen, 349
 Conifers diversify, 122
 Conifers dominate northern forests, 122
 Consciousness, 291
 Consent of the governed, 190, 193
 Conservation, 262
 Consolidated Silesian Steel, 493
 Conspicuous consumption, 244, 247
 Constitutional monarchy, 192
 Consumer's cooperatives, 233
 Consumerism, 256, 422
 Consumption, 247, 259, 260, 670
 Consumption of goods, 271
 Container ships, 305, 539
 Continued extraction of fossil fuels, 570
 Contracting economy, 260
 Control and communication, 289
 Convection currents, 57
 Converters, 241
 Conway's Life game, 324, 325
 Conway, John Horton, 324
 Cooperation, 477
 Cooperative Movement, 230, 233, 422
 COP24, 590
 Copernicus, 15, 17, 18, 23, 26, 178
 Copernicus, Nicolaus, 186
 Coppens, Yves, 128
 Corals, 122
 Core meltdown, 535
 Cornish tin mines, 208
 Corporations control governments, 678
 Corrupt governments, 371, 576
 Cosmetics and palm oil, 372
 Cosmic Dark Age, 44
 Cosmic dust, 669
 Cosmological constant, 34
 Cosmology timeline, 41
 Cosmonaut Yuri Gagarin, 354
 Cost of war, 491
 Cotton, 208, 225, 608
 Cotton domesticated, 152
 Cotton industry, 210
 Coulomb, Charles, 222
 Count Leo Tolstoy, 639
 Counter-culture, 244, 253, 256, 257
 Countess of Lovelace, 283
 Courage, 475
 COVID-19 pandemic, 457, 559
 Cowper, William, 198
 Cowpox vaccine, 431
 Crabs, 122
 Creating jobs, 570
 Creativity, 270
 Cretaceous period, 57
 Cretaceous-Paleogene Extinction, 122, 578
 Crick, Francis, 83, 85, 86, 99
 Crime of aggression, 665
 Crimes against humanity, 665
 Crimes, wars and murders, 193
 Crisis, 484
 Crisis of civilization, 668, 674
 Critical mass, 536, 539
 Cropland, area of, 164
 Cropland, limitations on, 164
 Crossing, 82
 Crown gall, 92
 Cruel, inhuman or degrading punishments, 659
 Cruelty by children, 483
 Cruelty to children, 212
 Crusades, 178, 483
 Crust, 57
 Crystallization, 311
 Crystallography, 83, 302, 310
 Crystals, 295, 435
 Cuba has sent doctors to help, 464
 Cuban Missile Crisis, 243, 494
 Cullen, William, 218
 Cultivation of potatoes, 157
 Cultural barriers to marriage, 480
 Cultural evolution, 182, 279, 309, 479, 480, 603, 670, 675

- Cultural history, 174, 675
 Cultural inertia, 593
 Culture of violence, 511, 518
 Cumulative risk, 507
 Cuneiform, 173
 Current annual emissions, 571
 Curvature of space, 34
 Cyanobacteria, 107
 Cybernetics, 287, 289, 293
 Cyberspace, 329
 Cycles of revenge and counter-revenge, 676
 Cyclic adenosine monophosphate, 108
 Cyclic AMP, 325
 Cyclic temperature changes, 99
 Cytochrome C, 100
 Cytosine, 83
 Cytoskeleton, 108
 Czar Alexander II, 242
 Czech Republic bans fracking, 573

 Dakar, 379
 Damage to infrastructure, 525
 Dances and songs, 483
 Dangers of nuclear power, 535
 Danish wind industry, 569
 Dark matter, 42, 43
 Dart, Raymond, 124
 Darwin's finches, 76
 Darwin, Charles, 70, 71, 73, 77, 80, 86, 94, 106, 207, 219, 223, 471, 483
 Darwin, Erasmus, 72, 198, 207, 219
 Darwinian evolution, 99
 Darwinian selectivity, 99
 Dasgupta, Sir Partha, 411
 Data banks, 302
 Davis, Ron, 91
 Davos Economic Forum, 583
 Dawkins, Richard, 326, 484
 DDT, 364, 366
 De revolutionibus orbium coelestium, 186
 De Vries, Hugo, 81, 320
 Deaths from heat, 377
 Deaths from starvation, 418

 Decay of democracy, 500
 Decimal system, 608, 634
 Decision hyperplane, 315, 319
 Declaration of Human Rights, 525
 Declaration of Independence, 190, 193
 Deepwater Horizon, 573
 Deer, 123
 Deforestation, 260, 372
 Deforestation in Amazonia, 372
 Degradation of topsoil, 364
 Degraded forests are carbon emitters, 378
 Dehydration reactions, 98
 Demand, 167, 247, 268
 Demands on the environment, 163
 Democratic Republic of Congo, 420, 511
 Democratization, 654
 Demographic transition, 228
 Demographic trap, 411, 418
 Demography, 259
 Demonstrations, 252
 Demoralizing effects, 210
 Dendrites, 310, 315
 Denisovans, 129
 Denmark, 19
 Deoxynucleotides, 93
 Depleted uranium shells, 526
 Depletion of minerals in soil, 164
 Depression, 266, 268
 Depression of 1929, 261
 Descartes, 26
 Desertification, 164, 167, 377, 420
 Desire for sons, 415
 Destruction of forests, 560
 Destruction statistically favored, 677
 Deterrence, flaws in concept, 502, 531
 Deuterium, 43
 Developing countries, 566, 576
 Development, 260, 522
 Devil's Dynamo, 500
 Devotion, 476
 Diagnosis, 303
 Dialects, 483
 Dialogues on ethics, 620

- Diamond Sutra, 182, 183
 Dicke, Peebles and Wilkinson, 40
 Dickerson, R.E., 100
 Dictatorships, 576
 Diction, 483
 Diderot, 431
 Diderot, Denis, 192
 Diet, 483
 Dietary changes can help, 376
 Differential and integral calculus, 281
 Differentiation, 109, 325
 Diffraction effects, 312
 Diffractometers, 302
 Digital organisms, 327, 330
 Digital universe, 308
 Dillehay, Tom, 155
 Dinosaurs, 122
 Dionysus, 623
 Diphtheria, 446
 Dirac, P.A.M., 281
 Direct costs of war, 522
 Directly used fuels, 540
 Disarmament, 502, 532
 Disease, 249, 420, 511
 Disease-resistant strains, 164
 Diseases related to poverty, 522
 Dismal Science, 212
 Dispersal of modern humans, 134
 Distanced from killing, 521
 Distilling, 218
 Distribution problems, 167
 Diverse populations, 479
 Diversification of birds, 122
 Diversity, 133
 Djibouti, 379
 DNA, 85, 86, 320
 DNA ligase, 91
 DNA structure, 82
 DNA template, 312
 DNA, mitochondrial, 133
 DNA, Y-chromosomal, 133
 Doctoral education, 201
 Domesticated dog, 148
 Domestication of animals, 150
 Domestication of the dog, 148
 Dominant genes, 81
 Donald Trump, 559
 Donald Trump's threats, 471
 Doolittle, W. Ford, 107
 Doping, 296, 298
 Doppler effect, 36
 Double-stranded DNA, 83
 Double-think totalitarian state, 585
 Drainage, 210
 Dreadnought-class ships, 489
 Drone operators, 521
 Drought, 167
 Drug addiction, 494
 Drug-resistant diseases, 656
 Drum parity, 294
 Dubois, Eugène, 124, 129
 Dumas, Jean Baptiste, 434
 Duve, Christian de, 104
 Dwarf peas, 80
 Dwarf planets, 57
 Dynamics of reactions, 303
 E. coli, 90
 E.O. Wilson, 484
 Earliest appearance of life, 121
 Earliest bees, 122
 Earliest earth, 121
 Earliest people in the Americas, 155
 Early agriculture in Egypt, 150
 Early Chinese writing, 176
 Early marriage, 418
 Early rice-growing in China, 153
 Earth, 57
 Earth is our mother, 389
 Earth Policy Institute, 564
 Earth Summit at Rio, 258
 Earth's capacity to regenerate, 163
 Earth's entire land surface, 376
 Earth's magnetic field, 57
 Earth's molten core, 71
 Earth's rotation, 57

- Earthquakes, 573
East Asia, 513
East-West exchanges in Toledo, 638
Eastern Asia, 164
Eastern Eurasia, 134
Eastern Europe, 294, 535
Echo of the Big Bang, 40
Eclipses, 13, 14, 19, 635
Eco RI, 91
Ecological breakdown, 589
Ecological conscience, 416, 592
Ecological damage, 526
Ecological Economics, 678
Ecological footprint, 163, 361, 586
Ecological systems, 258
Economic collapse, 422
Economic expansion, 260
Economic growth, 243, 253, 256, 260, 261
Economic inequality, 418
Economic influence, 500
Economic interdependence, 603, 647
Economic justice, 379
Economic progress, 411, 418
Economic system reform needed, 458
Economic tipping point, 567
Economic waste, 540
Economics, 190, 223, 226
Economics needs a social conscience, 677
Economics of Climate Change, 570
Economy of Brazil, 573
Ecstasy, 476
Ectotrophic fungi, 106
Edmond Halley, 29
Edna St. Vincent Millay, 624
Education, 192, 201, 231, 235, 269, 522
Educational reforms, 675
Educational theory, 639
Edward Jenner, 431
Edward Snowden, 653
Edwin Hubble, 36
Effects of war on children, 524
Egg cells, 81
Egypt, 420, 635
Egyptian hieroglyphics, 174
Ehrlich, Anne H., 381
Ehrlich, Paul, 311, 444
Ehrlich, Paul R., 381
Eibl-Eibesfeldt, Irenäus, 480, 484
Eightfold Way, 608
Einstein, Albert, 31
Eisenhower's farewell address, 500
Eisenstein, Sergei, 242
Ekert, J.P., 287
Elamite trading community, 173
ElBaradei, Mohamed, 505, 539
Elector of Hanover, 281
Electric cars, 567
Electric organs, 291
Electric spark, 95
Electric vehicles, 569
Electrical generating plants, 525
Electricity generation, 537, 540
Electrodynamics of Moving Bodies, 32
Electromagnetic forces, 42
Electromechanical calculators, 287
Electron microscopy, 83, 86
Electron spin resonance, 83
Electron transfer chain, 100
Electronic data, 304
Electronic digital computers, 287
Electronic valves, 296
Electrophoresis, 83, 93
Electrostatic complementarity, 444
Electrostatic forces, 84
Electroweak epoch, 42
Electroweak phase transition, 42
Elon Musk, 569
Emancipation of surfs, 242
Emancipation Proclamation, 233
Embedded computer, 304
Emerson, Ralph Waldo, 254
Emil Roux, 436
Emil von Behring, 446
Emissions have to stop, 580
Emmeche, Claus, 291
Emotions, 471

- Employment, 268
 Empty-world economics, 261
 Enclosure Acts, 209
 Encyclopedia, 190, 431
 End of Suburbia, 244
 Endemic conflict, 511
 Endoplasmic reticulum, 108
 Endosymbionts, 104, 134
 Endotrophic fungi, 106
 Ends and means, 252
 Ends do not justify means, 643
 Enemies, 252
 Energy, 386
 Energy crisis, 536
 Energy demand, global, 564
 Energy efficiency, 269, 560
 Energy for transportation, 422
 Energy use per capita, 564
 Energy-intensive agriculture, 163
 Energy-rich molecules, 94, 322
 Engels, Frederick, 212
 England, 189, 220, 248, 253
 English Bill of Rights, 650
 Engraved seals, 182
 ENIAC, 324
 ENIAC digital computer, 287
 Enlightenment, 189, 190, 192
 Enlightenment philosophy, 653
 Enrichment, 505
 Enrichment of uranium, 662
 Entertaining ourselves to death, 593
 Entropy, 289, 311
 Environment, 257, 260
 Environmental conscience, 465
 Environmental destruction, 671
 Environmental economics, 677
 Environmental holocaust, 526
 Environmental impact, 269
 Environmental protection laws, 416
 Environmental resources, 163
 Envy, 626, 671
 Enzymes, 85, 311, 436
 Epidemics, 523
 Epochs in cosmology, 41
 Equality, 190
 Equilibrium, 268
 Equilibrium economics, 262
 Equilibrium with the environment, 261
 Equity, 537, 581
 Eradication of smallpox, 522, 663
 Erasmus Darwin, 219
 Eratosthenes, 13
 Erie Railroad, 238
 Eris, 57
 Eritria, 511
 Ermland, 17
 Escalation of conflicts, 252, 676
 Escalatory cycles of violence, 502, 531
 Esperanto, 183
 Etched away by acid, 298
 Ethical end ecological considerations, 678
 Ethical message of Greek drama, 623
 Ethical message of Islam, 633
 Ethical principles, 484, 502, 531
 Ethical principles derived from science, 677
 Ethical systems, 647
 Ethics, 603, 647, 648
 Ethics can overwrite tribalism, 603, 672
 Ethics for the future, 674
 Ethiopia, 418, 420, 511
 Ethnic diversity, 479
 Ethnic identity, 480
 Ethnicity, 480
 Ethnicity and religion, 483
 Ethology, 291, 471, 473
 Eubacteria, 100
 Euclid, 633
 Euclidean geometry, 31
 Eukaryotes, 100, 108
 Eukaryotic cells appear, 121
 Eurasia, 148
 Euripides, 623
 Europe, 560
 European colonial conquests, 483
 European dark ages, 617
 European dependence on natural gas, 572

- European Space Agency, 359
Evolution, 76, 219, 635, 670
Evolutionary computation, 321
Evolutionary genetics, 310
Evolutionary trees, 100
Exceptionalism, 666
Excess charge, 311, 312, 445
Excess population, 212
Excessive consumption, 678
Excessive saving, 268
Execution of criminals, 642
Existential risk, 585
Existential risk to civilization, 587
Exodus from Africa, 133, 137, 138
Expanded German navy, 489
Expansion of the universe, 34, 36, 40
Experimental science, 189
Exploitation, 243, 250
Exploration of the Earth's Moon, 355
Exponential growth, 260, 261, 564, 593
Expression of emotions, 471
Extinction of marine species, 578
Extinction of terrestrial vertebrates, 578
Extinction of the human species, 559
Extortion, 539
Extrajudicial killings, 653
Extraterrestrial life, 41
Extreme heatwaves, 589
Extreme-weather events, 588
Extremophiles, 100
- F-factors, 91
Fabian Society, 248
Factory civilization, 250
Factory system, 207, 208, 210, 220, 224
Failure of epic proportions, 586
Failure to respond adequately, 592
Fairchild Semiconductor, 296
Fake news, 586
Fallout, 503, 533
Family of humankind, 679
Family planning, 377
Family planning information, 411
Family planning materials, 411
Family tree of dogs, 148
Family trees in evolution, 100
Famine, 160, 163, 242, 377, 411, 420, 506, 523
Famine involving billions of people, 559
Famine relief, 522, 643
Fanaticism, 476
FAO, 164, 372, 376
Farmer, James, 328
Fast breeder reactors, 537
Fast neutrons, 537
Fatal accident, 505
Father and brother, 198
FBI, 242
Fear of communism, 494
Federal Constitution of the United States, 650, 672
Federalist Papers, 651
Feed for livestock, 376
Feedback in biology, 289
Feedback loops, 559, 560, 588
Female lines, 134
Feminism, 214
Ferdinand II, 70
Fermentation, 436
Fermi, Enrico, 537
Ferns dominate land flora, 122
Ferocity, 247
Fertile land, 260
Fertility of mixed marriages, 480
Fertility rates, 201, 420
Fertilization of flowers, 106
Fertilized egg, 325
Feudal society, 203
Fiber optics, 302
Fischer, R.A., 477
Fielden, John, 210
Filed teeth, 483
Film animation, 305
Films that glorify war, 518
Filth, 210
Financial architects of Nazism, 492

- Financial book-keeping, 304
- Finite food supply, 260
- Finite supply of fossil fuels, 561
- Finland, 535
- Fire storms, 508, 529
- Fire, use of, 125
- Firebombing of Dresden, 502, 532
- Fires ignited by lightning, 560
- First appearance of water, 121
- First flies, 122
- First mammals, 122
- First multicellular organisms, 121
- First plants on land, 122
- First Red Scare, 242
- First songbirds, 122
- First stars, 44
- First true primates, 122
- First whales, 122
- Fiscal policy, 268
- Fish, 69
- Fisher, R.A., 289
- Fisk, Jim, 238
- Fission of uranium, 536
- Fission reaction, 527
- Fissionable isotopes, 505, 537
- Fissionable materials, 539
- Flags, 476
- Flemming, Walther, 81
- Floating-point operations, 298
- Flogging, 212
- Flood-control projects, 617
- Flops, 298, 299
- Florida under water, 588
- Florida, Richard, 270
- Flowering plants and pollinators, 122
- Fly squad, 82, 320
- Fock, V., 303
- Foerster, Heinz von, 290
- Folly, 671
- Food, 258
- Food and Agricultural Organization, 372, 376, 655, 656, 674
- Food insufficiency, 656
- Food processing, 379
- Food production, 164
- Food supply, 227
- Food, imported, 212
- Food-exporting countries, 163
- Food-scarce future, 160
- Footprint Network, 361
- Forbidden energy bands, 295
- Force of truth, 252
- Forced marriage, 418
- Foreign DNA, 91
- Forest destruction, 560
- Forest die-back, 588
- Forest drying and wildfires, 378
- Forest drying feedback loop, 378
- Forest loss and population, 376
- Forest resources, 377
- Forestry, 379
- Forests cover the land, 122
- Forge of Empires, 521
- Forgiveness, 253
- Formaldehyde, 95
- Formation of the earth, 57
- Formation of the oceans, 57
- Formation of the Sun, 57
- Former Soviet Republic, 164
- Former Soviet Union, 513
- Formic acid, 95
- Fosen project, 569
- Fossil fuel corporations, 567
- Fossil fuel extraction must stop, 582, 591
- Fossil fuel industry, 572
- Fossil fuel producers, 574
- Fossil fuels, 216, 269, 370, 559, 560, 592, 593
- Fossil fuels, continued extraction, 570
- Fossil fuels, rate of use, 564
- Fossilized footprints on land, 122
- Fossils, 70, 124
- Four-legged animals on land, 122
- Fox, Sidney, 98
- Fracking, 573
- Fracking banned by 9 countries, 573
- Fragile ecosystems, 260

- Framework convention, 259
France, 435, 489, 513
France bans fracking, 573
France bans internal combustion engine, 568
Frank Macfarlane Burnet, 452
Frank, Albert Bernard, 104
Frankenstein, 198
Franklin D. Roosevelt, 560
Franklin, Benjamin, 198, 219
Franklin, Rosalind, 83
Frederick II, king of Denmark, 19
Fredkin, Ed, 324
Free electrons, 43
Free energy, 100
Free speech movement, 256
Free trade, 243
Freedom of peaceable assembly, 651, 659
Freedom of religion, 651, 659
Freedom of speech, 651
Freedom of the press, 651
Freely evolving digital organisms, 328
French Academy, 436
French Revolution, 190, 192
French wine industry, 435
Frequency of mutations, 134
Fridays for the Future, 584
Friedman, Alexander, 39
Friedrich Krupp AG, 491
Friendship, 249
Frisch, Karl von, 473
Fruit flies, 82
Fruiting body, 108
Fruits of Philosophy, 214
Fuegians, 76
Fuel cells, 566
Full Spectrum Warrior, 519
Full-world economics, 261
Fully electric cars, 567
Fulton, Robert, 238
Fungi, 100
Fungi appear, 122
Fungi on land, 122
Fuselli, Henry, 198
Fusion energy, 540
Future dangers, 577
Future generations, 257
Future human needs, 586
Future of human civilization, 577
Future of megacities, 422
Galactic network, 307
Galapagos Islands, 76
Galen, 633
Galileo, 26, 28, 186
Gamow, George, 39
Gandhi, 641
Gandhi, Mahatma, 248, 249, 252
Gandhi, Mohandas, 248, 253
Garbage, 231
Garden of Eden, 671
Garrod's hypothesis, 85
Garrod, Archibald, 85
Gas chemistry, 222
Gas giants, 57
Gas production, 576
Gaskell, Peter, 209
Gate of Grief, 138
Gates, Bill and Melinda, 414
Gautama Buddha, 604, 648
Gay, John, 192
Gaza, 661
GDP per capita, 235
Gender equality, 412
Gene-spliced bacteria, 91
Gene-splicing techniques, 458
General Dynamics, 514
General glut, 268
General relativity, 39
General Theory, 266, 268
Generalization, 314
Generation and decay, 20
Genes, 477
Genesplicing, 92
Genetic algorithms, 310, 320
Genetic change, 479
Genetic code, 86

- Genetic drift, 134
 Genetic engineering, 90, 110, 670
 Genetic evolution, 309, 670
 Genetic lottery, 80, 133
 Genetic material, 83
 Genetic pool, 527
 Genetically homogenous tribes, 479
 Genetics, 80
 Geneva Convention, 464
 Geneva Conventions, 661
 Genius for cooperation, 603
 Genocide, 484, 502, 532, 629, 661, 665
 Genocide against Jews, 484
 Genocides and wars, 603
 Genomic DNA, 93
 Genotypes, 320
 Gentleman of the Court, 186
 Geography, 13
 Geological clock, 57
 Geology, 73
 George H.W. Bush, 492
 George W. Bush, 492
 Georges Köhler, 453
 Germ theory of disease, 436
 German nationalism, 483
 German naval buildup, 489
 German production of coal, 574
 Germanium, 296
 Germany, 437, 489
 Germany bans fracking, 573
 Germany bans internal combustion engine, 568
 Germany's armament industry, 492
 Giant anteaters, 123
 Gibbons, Ann, 137
 Gibbs free energy, 311, 329
 Gigaflop 11, 298
 Giganite herbivours, 122
 Gigawatts (GW), 563
 Gilbert, Walter, 92
 Giraffes, 123
 Glaciers melting, 160
 Glasgow, 219, 231
 Glasgow University, 206, 218
 Global catastrophic risk, 589
 Global ceasefire, 465
 Global Challenges Foundation, 588, 589
 Global Climate Disruption, 386
 Global climate strike, 584
 Global environment, 261
 Global ethic, 668, 674
 Global ethical principles, 603, 672
 Global fertility rates, 420
 Global food crisis, 160, 163
 Global hegemony, 513
 Global power, 513
 Global production of coal, 575
 Global warming, 167, 370, 536, 540
 Globalization, 243
 Globalization, negative aspects, 416
 Glorious Revolution of 1688, 189
 Glossopetrae, 70
 Gluttony, 625, 671
 Glyphs representing syllables, 177
 Gobi desert, 377
 God said: Let Newton be, 193
 Godwin, William, 198, 213
 Goldberg, David, 320
 Golgi apparatus, 108
 Gondisapur, 634
 Goodman, Amy, 510
 Goods, 269
 Goods per capita, 271
 Gorillas, 124
 Governmental expenditure, 264
 Governmental responsibility, 262
 Gracile skeletons, 125
 Gradient in pH, 103
 Gradual modification of species, 77, 78
 Grand National, 233
 Grand unification epoch, 42
 Grandmother's face cells, 319
 Graphics chips, 305
 Graphite moderator, 537
 Grasses diversify, 123
 Grasslands, 167

- Grasslands and savannahs, 123
 Grave implications, 500
 Gravitation, 24, 25, 27, 29, 30, 32
 Gravitational collapse, 44
 Gravitational red shift, 33
 Gray, Michael, 107
 Grazing mammals diversify, 123
 Great American Interchange, 123
 Great Depression, 266, 560
 Great Green Wall, 379
 Great mosque at Isfahan, 636
 Great Oxygenation Event, 121
 Great Wall of China, 617
 Great-power competition, 513
 Greece, 489
 Greed, 212, 625, 671
 Greek, 633
 Greek philosophers, 604, 648
 Green Belt Movement, 379
 Green Berets, 519
 Green New Deal, 560
 Green Revolution, 164
 Greenhouse gases, 378
 Greening of America, 257
 Greenland, 535
 Greenland ice cores, 578
 Greta Thunberg's TED talk, 579
 Grey, Colin S., 504, 534
 Gross injustice and terrible suffering, 678
 Gross national product, 260
 Grossman, Marcel, 32, 34
 Group identity, 479
 Group selection, 477
 Growth, 253, 260
 Growth implies future collapse, 593
 Growth of population and industry, 592
 Growth-oriented economics, 262
 Grundvig, N.F.S., 233
 Guanine, 83
 Guericke, Otto von, 204
 Guilt, 502, 532
 Guinea pig domestication, 156
 Gulf War of 1990, 525, 526
 Gun-type bomb, 539
 Guns, 491
 Guns in schools?, 518
 Gupta dynasty, 608
 Gutenberg's Bible, 186
 Gutenberg's printing press, 186
 Gutenberg, Johannes, 186
 Guterres, Antonio, 465, 582, 591

 Habitable Epoch, 44
 Hadian eon, 57
 Hadron epoch, 43
 Hadrons, 42
 Haeckel, Ernst, 100
 Haemophilus influenzae, 90
 Hagfish, 122
 Hague invasion clause, 665
 Hague Peace Palace, 241
 Hair standing on end, 475
 Hair-trigger alert, 504, 534
 Haldane, J.B.S., 94, 477
 Hall, Alen R., 103
 Halley, Edmond, 28
 Halobacterium halobium, 110
 Halobacterium salinarum, 313
 Hals, Franz, 189
 Halt extraction of fossil fuels, 582, 591
 Hamilton, Alexander, 651, 673
 Hamilton, W.D., 477, 484
 Hammurabi's Code, 604, 647
 Han dynasty, 617
 Hansen, James, 572, 587
 Hardware, 309, 310, 320
 Harmony with nature, 253
 Hartree, D.R., 303
 Harun al-Rashid, 634
 Harvard University, 385
 Harvestmen, 122
 Hate, 252
 Hawking, Steven, 281
 Hawthorne, Nathaniel, 254
 Health, 259
 Health care, 411

- Heat deaths in India, 572
 Heat of vaporization, 218
 Heavy elements, 669
 Heavy hydrogen, 43
 Heiliger Schauer, 475
 Heliocentric model, 15
 Heliocentric system, 18
 Helium, 222, 669
 Helium nuclei, 43
 Hemoglobin, 84, 85
 Henle, Jacob, 437
 Henry Cavendish, 222
 Henslow, John S., 73, 78
 Herbicides, 526
 Hereditary disease, 85
 Hermann Minkowski, 31
 Hero, 633
 Hero face, 475
 Hero of Alexandria, 349
 Heroic behavior, 476
 Heroism, 475
 Herschbach, Dudley, 303
 HEU, 537
 Hierarchal relationship, 86
 Hieroglyphic writing system, 174
 Hieroglyphics, 174
 Higgs bosons, 42
 High petroleum prices, 163
 High-yield agriculture, 164
 High-yield strains, 164
 Higher education for women, 411, 412
 Higher plants, 69
 Higher status for women, 411, 412
 Highly enriched uranium, 505, 507, 537
 Highway systems, 244
 Hinduism, 248, 607
 Hipparchus, 15
 Hippocrates, 633
 Hippocratic oath, 608
 Hippopotami, 123
 Hiroshige, 182
 Hiroshima, 476, 527, 535–537
 Histology, 315
 History, 483
 History of evolutionary theories, 69
 History of ideas, 178
 History of science and technology, 183
 Hitler as Chancellor, 494
 Hitler Youth, 476
 Hitler's rise to power, 491, 493, 494
 HMS Dreadnought, 489
 Hobson, John A., 267
 Hodgkin, Alan, 310
 Hodgkin, Dorothy Crowfoot, 84, 302
 Hoffmeyer, Jesper, 291, 327
 Hokusai, 182
 Holdren, John P., 385
 Holland, 189
 Holland, John Henry, 320, 326
 Hollerith, Herman, 286
 Hollywood blacklist, 243
 Holy shiver, 475
 Homanins diverge from apes, 123
 Homeostasis, 289
 Homespun cotton, 249
 Hominids, 124
 Homo erectus, 124, 125, 129
 Homo habilis, 123, 124, 126, 128
 Homo heidelbergensis, 129
 Homo neanderthalensis, 129
 Homo sapiens, 124
 Homo sapiens (archais), 126
 Homo sapiens neand., 126
 Homo sapiens sapiens, 125
 Hoodbhoy, Pervez, 538
 Hooke, Robert, 28, 29, 70, 189
 Hooker telescope, 36
 Hooker, Sir Joseph, 79, 94
 Hope for the future, 479, 668
 Horses, 123
 Hospitality, 483
 Hospitals, 303
 Hot springs, 100
 House of Commons, 189
 Howitzers, 491
 Huaca Prieta, 155

- Hubble space telescope, 36
Hubble's law, 36
Hubble, Edwin, 34, 36
Hubris, 623, 626
Hudson River Railroad, 238
Huge extinct quadrupeds, 76
Human cultural evolution, 193
Human Development Index, 420
Human ecology, 381
Human error and nuclear war, 528
Human failings, 504, 534
Human footprint, 361
Human greed and folly, 671
Human misery, 164
Human nature, 248, 483
Human prehistory, 133, 134
Human rights abuses, 371
Humanism, 638
Humanitarian law, 502, 504, 532, 533
Humanitarian tragedies, 517
Humanity on a Tightrope, 382
Humboldt, Alexander von, 73
Humility, 249
Hundreds of times faster and cheaper, 295
Hunter-gatherer ancestors, 670
Hunter-gatherers, 148, 479
Huntington Ingalls, 514
Hurricanes more severe, 587
Hutton, James, 71, 75
Huxley, Andrew, 310
Huxley, Thomas Henry, 106, 123
Huygens module lands on Titan, 359
Huygens, Christian, 30, 359
Hven, 20, 22
Hybrid cars, 567
Hybrids, 80
Hydrodynamics, 29
Hydrogen, 95, 222, 669
Hydrogen bonds, 83, 311
Hydrogen cyanide, 98
Hydrogen nuclei, 43
Hydrogen technology, 566
Hydrological cycle, 508, 530
Hydrophilic groups, 84
Hydrophobia, 441
Hydrophobic groups, 84
Hydrothermal vents, 99, 100
Hyenas, 123
Hyperthermophiles, 100
Hyrax Hill, 150
IAEA, 539
IBM Corporation, 286, 298
IBM machine, 294
ICAN, 667
ICC, 665
Ichthyosaurs, 122
Idealism, 621
Igneous rocks, 71
Ikon depicting Jesus, 629
Illegal burning of forests, 370
Illegal unwarranted searches, 653
Illegality of NATO, 657
Illegality of nuclear weapons, 502, 532, 657
Illegality of war, 654
Illiteracy, 522, 656
Illiteracy rates, 201
Ilya Mechnikov, 450
Imagine what we could do together, 582
Immediate action required, 582, 591
Immortal clones of lymphocytes, 457
Immune systems, 133, 450
Immunity, mechanism of, 444
Immunization, 431
Imperial College, 294
Imperial Mathematician, 22
Imprinting, 473
Impurities, 298
In silico, 326
In vitro, 326
Inadequate housing, 210
Inanimate matter, 69
Inappropriate agriculture, 378
Inballanced diet, 364
Incan language, 177
Incas built terraces, 157

- Incendiary bombings, 508, 530
- Income policies, 306
- Increased arms trading, 517
- Increasingly paranoid, 296
- Independent centers of origin, 150
- India, 160, 164, 173, 182, 248–250, 252, 253, 415, 420, 507, 513
- India's coal, 577
- India's Energy Crisis, 571
- India's nuclear weapons, 538
- India's palm oil demand, 372
- India's Prime Minister Modi, 571
- Indian flag, 249
- Indian home rule, 249, 252
- Indian ink, 182
- Indian Minister of Power, 572
- Indian monsoon disruption, 578
- Indirect costs of war, 522
- Indiscriminate mass slaughter, 502, 532
- Individual responsibility, 658
- Individual self-interest, 678
- Indo-Aryan culture, 607
- Indo-China conflicts, 523
- Indonesia, 370, 420, 576
- Indonesia's forest loss, 371
- Industrial activity, 264
- Industrial infrastructure, 592
- Industrial Revolution, 186, 203, 216, 230, 233, 489, 574, 678
- Industrial sector, 269
- Industrial workers, 270
- Industrialization, 249
- Industrialized countries, 576
- Industriousness, 189
- Inefficiency, 206
- Infanticide, 213
- Infinite desire for goods, 256
- Inflation, 264, 268
- Information, 299
- Information accumulation, 309, 479
- Information explosion, 176, 178, 309, 670
- Information technology, 279, 310
- Information-driven population growth, 160
- Information-related work, 270
- Infrastructure, 243, 522
- Initiating a war of aggression, 658
- Injustice, 248
- Ink, 182
- Inner core, 57
- Inner planets, 57
- Innocent until proved guilty, 659
- Input channels, 315
- Insect apocalypse, 364
- Insects, 69
- Insects appear on land, 122
- Insects diversify, 123
- Instantaneous worldwide communication, 603
- Instinctive behavior, 480
- Instincts, 471
- Institution of war, 507, 522
- Institution of war an anachronism, 670
- Institutional change, 670
- Institutional inertia, 592
- Insulator, 295
- Insulin, 84
- Integrated circuits, 298, 312
- Intel, 299
- Intense flooding, 587
- Intensive farming practices, 364
- Inter-group atrocities, 603, 672
- Interactive calculations, 299
- Interbreeding with Neanderthals, 129
- Interest rates, 268
- Interior of stars, 40
- Intermittency, Denmark and Germany, 566
- Intermittency, Denmark and Norway, 566
- Intermittency, problem of, 566
- Internal combustion engine ban, 567
- Internally displaced persons, 524
- International borders, 525
- International control, 505, 537
- International cooperation, 517
- International Court of Justice, 656
- International Criminal Court, 665
- International law, 160, 577
- International law and governance, 672

- International laws, 647
International Monetary Fund, 268
International peace and security, 654
Internet, 306, 307, 309
Internet traffic, 308
Internet users, total, 308
INTERNIST-1, 303
Interrelatedness of all life on earth, 677
Interrelatedness of species, 69
Intertribal aggression, 477
Intertribal massacres, 484
Intolerance, 192
Intragroup aggression, 473
Invasion of Transvaal, 489
Invention of agriculture, 603, 647, 671, 672
Invention of computers, 279
Invention of paper, 178
Invention of transistors, 295
Invention of writing, 173
Inventory data base, 304
Investment, 268
Investment in solar energy, 569
Investment opportunity, 567
Investments, 260
Invisible hand, 678
Ion pores, 311
IPCC, 167, 586, 590
Iran, 471, 507, 510, 513, 576, 663
Iran nuclear deal, 517
Iraq, 510, 576
Irish potato famine, 157
Iron and steel company, 491
Iron Law of Wages, 213, 226, 235
Iron-Sulfur reactions, 103
Irreversible adverse climate change, 587
Irreversible damage to civilization, 527
Irreversible feedback loops, 559
Isfahan, 636
Islam, 624
Islamic contributions to civilization, 633
Islamic hand-written manuscript, 183
Islamic physics, 635
Isotopes, 536, 538
Isotopes of uranium, 536
Israel, 513
Israel's nuclear weapons, 537
Italian paper-mill, 178
Italian Space Agency, 359
Italy, 489
Ituri Province of Congo, 484

Jabir, 634
Jacquard's loom, 283
Jacquard, Joseph Marie, 283
Jair Bolsonaro, 372
James Hansen, 572
James I, 20, 26
James Watt, 218
JANET, 307
Japan, 489
Japanese woodblock prints, 182
Jardin du Roi, 71
Jarmo, 150
Jawless fishes, 122
Jellyfish, 69
Jenner, Edward, 431
Jericho, 150
Jerne, Niels Kai, 452
Jewish employees, 494
Job security, 269
Jobs from renewables, 570
Jobs outside the home, 412
Johannes Kepler, 22
Johanson, Donald, 128
John Locke, 653
John P. Holdren, 385
John, Prince of Austria, 231
Johnson, Joseph, 198
Jointed shellfish, 69
Joseph Black, 218
Joseph Meitner, 443
Joseph Priestley, 222
Joyce, G.F., 322
Judaism, 624
Jupille, 443
Jupiter, 57

- Justice, 412
- Köhler, Georges, 453
- Kahn, Robert F., 307
- Kaiser Wilhelm II, 489
- Kaiser Wilhelm Institute, 32
- Kangaroos, 123
- Karma, 252
- Kauffman, Stuart, 99
- Keep that oil in the ground, 582, 583, 592
- Keeping up appearances, 244
- Kellogg-Briand Pact, 654
- Kendrew, J.C, 84
- Kennedy, John F., 355
- Kent, Duke of, 232
- Kepler, 22, 26, 27
- Kepler's laws, 25, 28, 30
- Kepler, Johannes, 19, 22, 186
- Keszthelyi, Lajos, 313
- Keynes, John Maynard, 262, 264
- Keynesian economics, 264
- Khan, A.Q., 538
- Khorana, H. Gobind, 86
- Killing, 642
- Kilowatts (KW), 563
- Kim Jong-un, 514
- Kindness, 477, 603, 647
- King George I, 281
- King Lear, 643
- King Louis XVI, 189
- King, Martin Luther, 253, 494
- Kings College, London, 83
- Kleinrock, Leonard, 306, 307
- Knotted string systems, 177
- Knowledge-based economies, 201
- Knowlton, Dr. Charles, 214
- Known resources, 560
- Koch, Robert, 437, 444
- Koestler, Arthur, 476
- Korea, 182
- Korean Peoples Army, 514
- Kornberg, Arthur, 86
- Kosovo, 484
- Krakow, 17
- Kristallnacht, 494
- Krupp family business, 491
- Kuffler, Steven W., 319
- Kuiper belt, 57
- Kull, K., 291
- Kurdish civilians gassed, 484
- Kuwait, 576
- L-3 Communications, 514
- L3 lineage, 134
- Löwdin, Per-Olov, 303
- Lack of safe water, 656
- Ladik, Janos, 294
- Lady Mary Wortley Montague, 192
- Laetoli footprints, 125
- Laing, Richard, 326
- Lake Rudolph, 124
- Lamarck, J.B. de, 72
- Land Mammals, 69
- Land scorpions, 122
- Land surface used for cattle, 376
- Landscape fires kill 100,000/y, 371
- Langton, Christopher, 325
- Language and ethnic identity, 483
- Languages, 480
- Lao Tzu, 604, 616, 648
- Lapps, 479
- Large families, 415
- Large flightless birds, 122
- Large sharks, 122
- Largest company in Europe, 491
- Laser, 304
- Last frontier, 164
- Last glacial maximum, 148
- Last universal common ancestor, 121
- Late Devonian Extinction, 578
- Latent heats, 218
- Lateral toes, 71
- Latin America, 164
- Lavoisier, Anton, 222
- Law, 603
- Laws acting on individuals, 651, 673

- Laws binding on individuals, 656
Laws of motion, 27
Lead, tin and antimony, 186
Leaky, Louis, 128
Leaky, Louis and Mary, 124
Leaky, Mary, 128
Leaky, Richard, 128
Learning, 314, 318
Learning by computers, 309
Least developed countries, 418
Lebanese civil war, 484, 523
Lebanon, 510
Leclerc, Georges-Louis, 71
Lederberg, Joshua, 91
Lee, Yuan, 303
Leeuwenhoek, Anton van, 189
Leewenhoek, Anton van, 434
Legal systems, 647
Lehn, J.-M., 312
Leibniz, Gottfried, 28, 204
Leibniz, Gottfried Wilhelm, 279, 281
Leisure class, 245
Lemaitre, Georges, 39
LeMay, General Curtis E., 504, 534
Lenin, V.I., 242
Lenton, Timothy Michael, 578
Leonardo da Vinci, 17, 70, 178, 186
Leonardo-Finmeccanica, 514
Leontief, Wassily W., 305
Lepton epoch, 43
Leptons, 42
Lerma Rogo, 164
Letter to Santa Claus, 660
Letters Concerning the English, 192
LEU, 537
Levitt, Henrietta Swan, 36
Lewin, Kurt, 290
Liberalism, 248
Liberty, 653
Library at Alexandria, 13
Libya, 510, 576
Licences to burn forests, 371
Lichens, 122
Licklider, J.C.R., 307
Lie detector test, 296
Liebig, Justus von, 436
Life, 653
Life balanced over an abyss of chaos, 677
Life elsewhere in the universe, 110
Life in the Solar System, 359
Life-oriented vision, 412
Life-supporting systems, 260
Lifestyles, 235, 560
Light weapons, 511
Lightning strokes, 95
Limitations on cropland, 164
Limits for adaption, 589
Limits to Growth, 163, 593
Lincoln, Abraham, 233
Lindenmayer, Astrid, 326
Linguistic ability, 138
Linnaeus, Carolus, 71, 123, 434
Linnean Society, 79
Linus Pauling, 452
Lions, 123
Lipid bilayer, 311
Lipids, 100
Liquid water, 44, 57
Lister, Sir Joseph, 444
Literature, 483
Literature searches, 303
Lithium, 43
Lithium ion storage batteries, 569
Lithium ion storage cells, 566
Lithoautotrophs, 103
Lithosphere, 57
Living from war, 500
Living standards, 235, 269, 577
Livingston, Robert, 238
Llama domestication, 156
Local communities, 483
Local currencies, 422
Local self-sufficiency, 422
Lock and key mechanism, 311, 444
Locke, John, 190, 193, 653
Lockheed Martin, 514

- Logic density, 299
 Long human childhood, 603, 672
 Long-term future, 422, 560
 Look for action. Then hope will come, 594
 Looming financial instability, 586
 Loons, 122
 Lord and Lady Byron, 283
 Lord Moulton, 282
 Lorenz, Konrad, 291, 473, 475, 477, 480
 Loss of 175 million lives, 526
 Loss of flying insects, 364
 Loss of life, 523
 Lost in the stars, 18
 Love, 252, 253, 642
 Love and respect Mother Earth, 392
 Love for the poor, 640
 Lovelace, Countess of, 283
 Low enriched uranium, 537
 Low wages, 213
 Low-carbon economy, 582, 591
 Lowell, James Russell, 256
 Lower mantle, 57
 Loyalty, 476
 Loyalty to humanity as a whole, 674
 Lucy, 128
 Ludendorff, 494
 Lunar Society, 221
 Lust, 625, 671
 Luther, Martin, 186
 Luxembourg bans fracking, 573
 Luxuries, 254
 Lyell's hypothesis, 75
 Lyell's theories, 76
 Lyell, Sir Charles, 70, 71, 75, 78
 Lymphocytes, 450
 Lysistrata, 623
 Lysozyme, 84

 M and N lineages, 134
 M168 mutation, 133
 M242 mutation, 133
 Maathai, Wangari, 379
 Machine instructions, 298
 Machinery, 250
 Machines, 250
 Macy Conferences, 293
 Macy Foundation, 290
 Madam du Chatelet, 193
 Maddison, Angus, 235
 Maer, 78
 Mafia, 539
 Magdalenian, 125, 127, 147
 Magdeburg hemispheres, 204
 Magna Carta, 649
 Magnetic bottles, 540
 Magnetic disc memories, 299
 Magnetic fields, 57
 Magnetic ink, 305
 Magneto-hydrodynamics, 57
 Mahatma Gandhi, 248, 249, 253, 641
 Main-sequence stars, 40, 44
 Mainz, Germany, 186
 Maize domesticated, 152
 Maize, squash and beans, 156
 Major coal producers, 575
 Major fossil fuel producers, 574
 Major oil producers, 574
 Major tectonic plates, 57
 Malaria, 364
 Male lines, 134
 Malnutrition, 364, 522, 523
 Malthus, T.R., 78, 198, 212, 214, 227, 260, 267
 Malthusian forces, 227, 420
 Mammalian retina, 319
 Mammals become dominant, 122
 Mammoth hunting with dogs, 148
 Man, 69
 Man and the Ecosphere, 381
 Man is born free, 193
 Man-made disaster, 582, 591
 Man-made forms of life, 92
 Manchester, 231
 Mann, Michael E., 587
 Manuscript production, 178
 Marcel Grossman, 32, 34

- Marginal land, 164, 260
Market forces, 269
Market mechanisms, 251, 262
Marquis du Châtelet, 192
Marriage, 214, 477
Marriage across ethnic boundaries, 484
Mars, 57
Marshall Plan, 266
Marsupials, 77
Martin, William, 103
Marx, Karl, 212, 242
Mason, George, 651, 673
Mass extinctions, 216
Mass media, 519, 580, 593
Mass-producing movable type, 186
Massacres, 484
Massive non-linear events, 588
Massive nuclear retaliation, 502, 531
Mastodons, 123
Material goods, 256
Material progress, 674
Mathematical natural laws, 41
Mathematics, 26, 608, 622
Mattas, James, 513
Matter and radiation equivalence, 43
Matter era, 43
Matthaei, Heinrich, 86
Matthew Boulton, 219
Mauchley, J.W., 287
Maxwell's equations, 32
Mayan system of writing, 177
Mayan writing, 177
McCarthy, Joseph, 243
McCarthyism, 242
McCulloch, Warren, 290, 314, 322
MCIR system, 305
Mead, Margaret, 290, 293
Meadows, Dennis L., 163
Means, 252
Mechanics, 29
Mechanism of immunity, 444
Mechanism of the brain, 310
Mechanization of agriculture, 305
Mechnikov, Ilya, 450
Medical care, 231
Medical consequences of war, 523
Medical degrees for women, 412
Medicine, 303, 431, 436, 608, 634
Megacities, 422
Megawatts (MW), 563
Mellars, Sir Paul, 134, 137
Melted asphalt, 572
Melting of Glaciers, 160
Melting of polar icecaps, 588
Membrane-bound proteins, 311
Memories, 299
Memory density, 312
Mendel, Gregor, 80
Mendelian laws, 81
Mercury, 57
Mercury computer, 294
Mertz, Janet, 91
Mesopotamia, 173
Messenger RNA (mRNA), 86
Metabolism, 86, 103
Metal-containing proteins, 85
Metallurgy, 608
Meteoric impacts, 95
Methane, 94, 95
Methane and beef, 372
Methane hydrate feedback loop, 578, 579
Methods of production, 216
Mexico, 420, 576
Micro-organisms, 435
Microbial life on land, 121
Microelectronics, 295, 298, 312
Microminiaturization, 294
Microprocessors, 298, 299
Microscope, 189, 298, 310, 434
Microwave background radiation, 39
Microwave horn antenna, 39
Middle East, 570
Middle East conflicts, 517
Miescher, Friedrich, 82
Migrations, 479
Militant enthusiasm, 475, 476

- Militarism and money, 471
 Militarism in North Korea, 513
 Militarization of governments, 576
 Military Expenditure Database, 514
 Military mentality, 31
 Military technology, 517
 Military use of oil, 576
 Military-industrial complex, 471, 491, 500
 Mill, James, 213, 268
 Mill, John Stuart, 160, 213
 Millay, Edna St. Vincent, 624
 Millennium Development Goals, 660
 Miller, Stanley, 95
 Miller-Urey experiment, 95, 98
 Milstein, César, 453
 Mine Ban Treaty, 665
 Miner's Friend, 204
 Miniaturization, 298, 299, 310
 Minicomputer, 298
 Minimum wage law, 213
 Minimum wage laws, 230, 233, 243, 267
 MIPS, 298
 Mirror images, 435
 Miscalculation, 504, 534
 Misery, 213, 214
 Misery of factory workers, 212
 Misplaced power, 500
 Missile defense system, 507
 Missile Envy, 494
 Mistaken for a missile strike, 504, 534
 MIT Technology Review, 571
 Mitochondria, 106, 108
 Mitochondrial DNA, 133, 134
 Mitochondrial Eve, 134
 Mitotic cell division, 108
 Modern elephants, 123
 Modern mammal groups appear, 123
 Modern phyla of animals, 121
 Modern scientific era, 178
 Modern societies, 201
 Modern warfare and oil, 576
 Modernism, 507
 Mohenjo.Daro, 607
 Molecular biology, 80, 83
 Molecular complementarity, 310, 311, 444
 Molecular dynamics, 303
 Molecular natural selection, 99
 Molecular oxygen, 107
 Molecular switches, 313
 Molluscs, 69
 Monetary policy, 268
 Money and growth our main concerns, 583
 Money driving decisions, 572
 Money supply, 267
 Money-dominated society, 203
 Mono-cropping, 364
 Monoclonal antibodies, 453, 457, 458
 Monotremes, 122
 Monsoon disruption, 578
 Montesquieu, 192
 Montessori, Maria, 412
 Moon's orbit, 27, 30
 Moon's size, 14
 Moons, 57
 Moore's law, 299, 309, 310
 Moore, Gordon E., 296, 299
 Moral philosophy, 620
 Moral responsibility, 583
 More military spending, 517
 More than hope, we need action, 582
 More violent conflicts, 517
 Morgan, Thomas Hunt, 82, 320
 Morland, Sir Samuel, 204
 Morphogenesis, 325, 326
 Moses, 604, 648
 Mother Earth, 389
 Moths, 123
 Motorboats, 244
 Mount Wilson Observatory, 36
 Mountain ranges, 57
 Mousterian, 127
 Moustrian, 125
 Movement of refugees, 517
 Muhammad, 604, 648
 Muller, Hermann J., 82, 320
 Mullikin, R.S., 303

- Mullis, Kary, 92
Multi-ethnic groups, 603, 672
Multi-state cells, 323
Multicellular organisms, 104, 109
Multinational network, 493
Multiplication, 279
Multiplication and division, 281
Murder, 642
Musharraf, Pervez, 538
Music synthesizers, 305
Musk, Elon, 569
Muslim world, 178
Mutant genes, 82
Mutant strains, 85
Mutants, 322
Mutation, 320
Mutations, 81, 133, 670
Mutualism, 104
Mutually Assured Destruction, 534
Mychorrhizal fungi, 106
Myoglobin, 84
Myeloma cells, 457
Myopic national self-interest, 585
Mysterium Cosmographicum, 24
- Nüremberg Principles, 253
Nagasaki, 476, 535–537
Nanocircuits, 312
Nanometer range, 312
Nanoscale circuit templates, 313
Nanotechnology, 312
Napoleon III, 436
Napoleonic Wars, 232
Narrow and shrinking window, 591
NASA, 359
NASA photographs of the Moon, 356
Nathans, Daniel, 90
National pride, 507
National Rifle Association, 518
Nationalism, 476
Nationalism a dangerous anachronism, 592
Nationalism and religion, 483
Nationalism, nuclear, 538
- Natural capital, 260
Natural gas production, 576
Natural philosophy, 620
Natural satellites, 57
Natural selection, 69, 78, 99, 320, 322, 327, 477
Nature, and nature's laws, 193
Naval arms race, 489, 494
Naval supremacy, 489
Navigant Research, 569
Nazi Germany, 492
Nazi Party, 483, 492, 494
Nazi V2 rocket, 349
Neanderthal man, 123, 125, 129
Neanderthals, 137
Near East, 164
Need for a new economic system, 677
Negative feedback, 291
Neolithic agricultural revolution, 160
Neolithic ancestors, 670
Neolithic founder crops, 152
Neolithic site in eastern China, 153
Neolithic stone tools, 138
Neptune, 57
Neptunium, 540
Nerve cells, 310
Nerve endings, 444
Nerve gas, 670
Nervous system, 310
Nestorians, 633
Netherlands bans petrol driven cars, 568
Networks, 299
Neumann, John von, 287, 289, 322, 326
Neural networks, 309, 314
Neurons, 315
Neurophysiology, 289, 310, 315, 319
Neurospora, 85
Neurotransmitter molecules, 315
Neutral countries, 502, 532
Neutrinos, 43
Neutrons, 43, 536
New Agenda Resolution, 504, 533
New clothes, 254

- New Deal, 268, 560
 New era of happiness, 192
 New Harmony, 232, 233
 New Joan of Arc, 583
 New Lanark, 231
 New species, 70
 Newcomen engine, 204, 206, 208, 219
 Newcomen, Thomas, 204
 Newman, M.H.A., 287
 Newton's critical experiment, 27
 Newton's equations of motion, 32
 Newton's laws of gravitation, 33
 Newton's Principia, 80
 Newton, Isaac, 26, 186, 189, 190, 193, 281
 Nicholas, Grand Duke, 231
 Niels Kai Jerne, 452
 Nigeria, 377, 420
 Nile valley, 150
 Nirenberg, Marshall, 86
 Nitrogen, 222
 Nitrogen-fixing bacteria, 106
 Njal's Saga, 647
 No one ever talked about it, 580
 No rightful duty to submit, 193
 Nobel Peace Prize, 386, 667
 Nobody listens, 629
 Nodes, 306
 Non-Euclidean geometry, 34
 Non-Proliferation Treaty, 537
 Non-renewable resources, 261
 Non-violence, 249, 250, 252, 253
 Non-violent protest, 248, 252
 Nonrenewable resources, 361
 Nonviolent civil disobedience, 642
 Normative value, 660
 North America, 560
 North Korea, 471, 507, 513
 North Korea's nuclear weapons, 537
 North Sea oil, 574
 Northern Africa, 164
 Northern Ireland bans fracking, 573
 Northrop Grumman, 514
 Norway bans petrol driven cars, 568
 Norwegian mass-murderer, 521
 Norwegian North Sea oil, 574
 Novik, Richard, 91
 NPT, 537, 662
 NPT, threatened failure of, 538
 NSFNET, 307
 Nuclear arms race, 494
 Nuclear Ban Treaty, 667
 Nuclear black market, 505
 Nuclear catastrophe, 527
 Nuclear darkness, 506
 Nuclear deterrence, flaws, 505
 Nuclear environmental catastrophe, 508, 529
 Nuclear forces, 42
 Nuclear fusion, 540
 Nuclear magnetic resonance, 83
 Nuclear nationalism, 538
 Nuclear Non-Proliferation Treaty, 662
 Nuclear power dangers, 535
 Nuclear power generation, 494, 536, 662
 Nuclear power plant accidents, 528
 Nuclear proliferation, 243, 505, 536–538
 Nuclear reactions, 40, 57, 669
 Nuclear reactors, 505, 537
 Nuclear terrorism, 243, 505, 507, 538
 Nuclear tests, 526
 Nuclear war, 629
 Nuclear war by accident, 539
 Nuclear war is possible, 588
 Nuclear warhead stockpiles, 514
 Nuclear weapons, 243, 494, 670
 Nuclear weapons are genocidal, 661
 Nuclear winter, 508, 529
 Nucleic acids, 98
 Nucleon number, 536
 Nucleosynthesis, 43
 Nucleotide sequences, 310
 Nucleus, 108
 Nuremberg Principles, 540, 657
 Obama, Barack, 386
 Obesity, 418
 Obscenely enormous military budgets, 677

- Obscenity trial, 214
 Observable universe, 669
 Observation, 189
 Oceanic-continental convergence, 57
 Oceans, 260
 Ocha, Sevaro, 86
 October Revolution, 242
 Octopuses and squids, 69
 Ode to Joy, 674
 Ogallala aquifer, 164
 Oil depletion, 244
 Oil producers, 574
 Oil reserves in OPEC countries, 570
 Oil sands in Canada, 572
 Oil spills, 526
 Oklahoma, 167
 Oldowan, 125, 127
 Olduvai gorge, 124
 Oligonucleotides, 93
 Ontogeny, 100
 Oparin, A, 94
 OPEC countries, 570
 Optical activity, 434
 Optical memories, 314
 Optical storage devices, 299
 Optics, 26, 635
 Optimum global population, 160
 Order, construction and complexity, 677
 Ordovician-Silurian Extinction, 578
 Organized criminals, 538
 Orgel, Leslie, 99
 Origin of life, 94, 99
 Origin of Species, 77
 Orinoco River, 573
 Orwell, George, 585
 Oslo Principles, 666
 Osterhelt, D., 313
 Ottawa Treaty, 665
 Ottoman Empire, 489
 Our Common Future, 257
 Our house is on fire, 583
 Our leaders are behaving like children, 583, 592
 Outer core, 57
 Output channel, 315
 Overconsumption, 258
 Overfishing, 361
 Overgrazing, 167, 378
 Overuse of pesticides, 364, 366
 Owen, Richard, 233
 Owen, Robert, 230, 231
 Owen, Robert Dale, 233
 Oxidative phosphorylation, 134
 Oxygen, 44, 104, 222
 Oxygen crisis, 108, 134
 Ozone layer, 506, 509, 530
 Ozone layer formed, 121

 Pääbo, Svante, 129
 Pace of change, 589
 Pacific islands, 77
 Package switching systems, 306
 Paine, Thomas, 198
 Pakistan, 164, 167, 420, 507, 513
 Pakistan's nuclear weapons, 538
 Palade, George Emil, 86
 Palaeolithic tools, 138
 Pale-faced teenagers, 294
 Palestinians, 524
 Palm oil and biodiversity, 371
 Palm oil cultivation, 370
 Palm oil plantations, 370
 Pandemics of the past, 458
 Paper, 17, 178, 182, 617
 Paper in the Muslim world, 178, 185
 Papin's steam engine, 206
 Papin, Denis, 204
 Papyrus, 178
 Parable of the Good Samaritan, 629
 Parallax, 18
 Parallel-processing, 298
 Parallelization, 299
 Paranthropus robustus, 126
 Parasites, 133
 Parasitism, 104
 Parchment, 178

- Paris, 635
 Paris Agreement, 581, 585, 588, 591
 Paris Climate Agreement, 517
 Parliamentary democracy, 253
 Parrots, 122
 Pascal, 19
 Pascal, Blaise, 279
 Passive resistance, 642
 Pasteur Institute, 443
 Pasteur, Louis, 434
 Pasteur, Marie, 442
 Pasturage, 164
 Pasteurization, 436
 Pathogenic bacteria, 444
 Patriotism, 476
 Pattern abstraction, 319
 Pattern recognition, 319
 Pattern space, 315
 Pattern vector, 318
 Pattern-recognition, 314
 Paul Ehrlich, 509, 531
 Paul R, Ehrlich, 381
 Pauling, Linus, 83, 85, 303, 452
 Pauperism, 232
 PC hard-drive capacity, 299
 PCR technique, 93, 99
 Peace education, 656
 Peace in Colombia, 517
 Peanut butter and palm oil, 372
 Pearl Harbor, 518
 Peat fires, 371
 Peatlands, 370
 Peking man, 125
 Peloponesian War, 621
 Penzias, Arno, 39
 People walked from Siberia, 155
 People without electricity, 565
 People's High Schools, 233
 Per capita energy use, 560
 Percentage without schooling, 201
 Perfectibility of society, 192
 Permafrost melting, 578
 Permanent arms industry, 500
 Permian-Triassic extinction, 122, 578
 Persecution of Christians, 494
 Persia, 633, 634
 Persian, 633
 Persistent organic pollutants, 364
 Personal memories of early computers, 293
 Perutz, Max, 84
 Petri dish, 437
 Petrobras, 573
 Petroleum price, 163
 Petroleum production in Russia, 572
 Petroleum-derived fertilizer, 364
 Petrov, Stanislav, 535
 Phagocytes, 444
 Phagocytosis, 108, 450
 Phagocytosis and symbiosis, 121
 Phenotypes, 320
 Phenylalanine, 86
 Philanthropy, 238
 Phillipines, 420
 Phillips, D.C., 84
 Philosophes, 192
 Phoenician alphabet, 174
 Phoenicians, 174
 Phoenix Farm, 249
 Phonetic system of writing, 174, 176, 182
 Phosphate esters, 98
 Phospholipid molecules, 311
 Photoautotrophs, 104
 Photoelectric effect, 32
 Photographs returned by Cassini-Huygens, 359
 Photolithography, 312
 Photon epoch, 43
 Photons, 44
 Photoresist, 298, 312
 Photosynthesis, 94, 106, 134, 303, 313
 Photosynthetic bacteria, 104
 Photosynthetic cyanobacteria, 121
 Photosystems I and II, 107
 Photovoltaics, rate of growth, 564
 Phylogeny, 100
 Physical constraints, 261

- Physical properties, 536
 Pictographic symbols, 174
 Pierce, Charles Sanders, 291, 324
 Pieter de Hooch, 189
 Piezoelectric crystal, 313
 Pigs, 123
 Pigs domesticated, 152
 Piki Mach'ay, 156
 Pithecanthropus erectus, 124
 Pitts, Walter, 290, 314, 322
 Place, Francis, 213
 Placental mammals, 122
 Plague years, 27
 Plague, bubonic, 212
 Planck epoch, 41
 Planetary atmospheres, 98
 Planetary boundaries, 586
 Planetary nebula, 40
 Plans for blockade, 489
 Plant genetics, 164
 Plant kingdom, 69
 Plants, 100
 Plasma physics, 385
 Plasmids, 91
 Plate tectonics, 57
 Plato, 23, 620, 621, 633
 Pluto, 57
 Plutonium, 505, 536–538
 Pneumatics, Table of, 205
 Pneumococci, 82
 Poetry, 483
 Poison gas, 32, 484
 Poisoning of water supplies, 573
 Poland, 17
 Polanyi, J., 303
 Polarimetry, 435
 Polarizable groups, 312
 Polarization, 434
 Polarized light, 291
 Policymakers' magical thinking, 586
 Policymaking cognitatively dissonant, 585
 Polish production of coal, 574
 Polite conversation, 593
 Politeness, 603, 647
 Political expediency, 585
 Political influence, 500
 Political instability, 517
 Political liberty and equality, 192
 Political philosophy, 190
 Political philosophy: the Enlightenment, 189
 Political reforms, 192
 Political representation of women, 412
 Political will, 560
 Politicians, next election, 577
 Pollination, 80
 Pollution, 656
 Polyhedra, 23
 Polymerase, 86
 Polymerase Chain Reaction, 92, 99, 330
 Polynucleotides, 99
 Polypeptides, 84, 98, 99
 Polypeptides and polynucleotides, 294
 Ponnampereuma, Cyril, 98
 Poor rural communities, 377
 Pope Francis, 632
 Pope, Alexander, 192, 193
 Popularity and ratings, 593
 Population, 260, 271, 670
 Population Action International, 377
 Population and forest loss, 376
 Population crash, 163, 411
 Population density, 160, 163
 Population density and forest size, 372
 Population driven by fossil fuel use, 160
 Population explosion, 309, 361
 Population genetics, 477
 Population growth, 78, 167, 212, 213, 226–
 228, 258, 260
 Population overshoot and crash, 160
 Population projections in Africa, 420
 Population stabilization, 269, 411, 418, 656
 Population, Resources, Environments, 381
 Populations in the tropics, 377
 Position of genes, 82
 Post-doctoral education, 201
 Post-fossil fuel world, 586

- Post-synaptic cleft, 315
 Postman, Neil, 593
 Potassium, 634
 Potato, 212
 Potato cultivation, 157
 Potato domesticated, 152
 Potentially irreversible threat, 590
 Potter cord, 204
 Potter, Humphrey, 204
 Poverty, 212, 214, 249, 259, 261, 656
 Poverty generated by war, 525
 Power, 208, 219, 247, 253
 Power reactors, 537
 Powers of government, 269
 Prague, 22, 24
 Pre-Colombian Argentina, 157
 Pre-industrial cultures, 253
 Precursors of mammals, 122
 Predatory culture, 245
 Preemptive wars, 654
 Prehistoric family trees, 133
 Preparation for war, 494
 Presalt oil, 573
 Prescott Bush, 492
 Pressure cooker, 204
 Pressure on land, 260
 Preventable diseases, 411, 522, 523
 Price of petroleum, 163
 Price, Richard, 198
 Pride, 626, 671
 Priest writing, 174
 Priestley, Joseph, 198, 221, 222
 Primary energy, 560
 Primary health care, 411, 413
 Primer, 93
 Primes, 13
 Primitive atmosphere, 94
 Primitive class structure, 245
 Princeton University, 39
 Principia, 29, 30, 190
 Principia Mathematica, 193
 Principle of Equivalence, 33
 Principle of subsidiarity, 653
 Principles of Political Economy, 163
 Printing, 17, 160, 178, 182, 203, 217
 Printing and the Reformation, 186
 Printing in Egypt, 183
 Printing in Europe, 193
 Printing invented in China, 176
 Printing with movable type, 176, 182, 186
 Prison, 252
 Private automobiles, 244
 Producer, 267
 Producers' cooperatives, 233
 Production, 670
 Production of natural gas, 576
 Profits, 260
 Profits of stockholders, 592
 Prokaryotes, 91, 100
 Proliferation risks, 537, 538
 Proliferation, nuclear, 536, 538
 Prolonged education, 176
 Property rights for women, 412
 Prostitution, 213
 Protein chain, 86
 Protein structure, 84, 310
 Proteins, 311
 Proton pump, 314
 Protons, 43, 536
 Protoplanetary disc, 57
 Protostars, 40
 Prussian army officers, 480
 Pseudospeciation, 480
 Psychological effects of war, 523
 Psychology, 190, 244
 Ptolemy, 17, 633
 Ptolemy, Claudius, 15
 Pu-239, 537, 539
 Public health, 522
 Public opinion, 536
 Public transportation, 244, 269
 Pugwash Conferences, 382, 385
 Pullman, Alberte, 303
 Pullman, Bernard, 303
 Pumps, 204
 Punched cards, 283, 294

- Purchasing power, 268
Puritan Rebellion, 189
Purple membrane, 313
Pursuit of happiness, 653
Pyrite formation, 103
Pythagoras, 23, 621
Pyush Goyal, 572
- Quantum biochemistry, 303
Quantum chemical calculations, 294
Quantum chemistry, 303
Quantum dot technology, 299
Quantum dots, 299
Quantum effects, 313
Quantum theory, 295, 309, 670
Quark epoch, 42
Quark-gluon plasma, 42
Quasars, 44
Quasi-religious cults of nationalism, 675
Queen Elizabeth I, 157
Quick action, 560
Quick Medical Reference, 303
Quorum sensing, 108
- R-factors, 91
R-type pneumococci, 82
Rabies, 441
Racemic acid, 434
Rachel Carson, 366
Racial cleansing, 484
Racism, 248, 666
Radar, 504, 534
Radiation sickness, 527
Radical transformation, 591
Radio-carbon dating, 150, 173
Radioactive decay, 95
Radioactive decay products, 40
Radioactive fallout, 526, 535
Radioactive graphite, 535
Radioactive grass, 535
Radioactive tracer techniques, 83
Radioactive tracers, 86
Radioactive uranium, 535
- Radioactive waste disposal, 536
Radiocarbon dates, 155
Radius of the earth, 13
Rahzes, 634
Rainbow, 635
Rainfall, 167
Raleigh, Sir Walter, 157
Rampino, Michael R., 137
Random mutations, 320
Rank-determining fights, 473, 476
Rapid and unprecedented changes, 590
Rapid change is required, 581
Rapidly rotating drum, 294
Rasmussen, Steen, 328
Rate of fossil fuel use, 564
Rates of scientific discovery, 670
Ratfishes, 122
Rationalism, 190
Rationality, 193
Ray, Thomas, 327, 330
Ray-finned fishes, 122
Raychandbhai, 249
Raytheon, 514
Reactive groups, 312
Reactive scattering, 303
Real needs, 261
Realistic view of the world, 189
Rearmament, 494
Reason, 193
Receptors, 315
Recession, 267, 268
Recessive genes, 80
Reciprocity, 252
Recombinant DNA, 90
Reconciliation, 248, 252, 253
Record-breaking heatwaves, 587
Recycling resources, 269
Red Dawn, 518
Red giants, 40
Red Sea, 138
Red shift, 36, 40
Redox potential, 103
Redshift, 44

- Reducing agents, 103
- Reducing atmosphere, 94
- Rees, William, 163
- Reflexive catalysis, 99
- Reforestation, 269
- Reforestation initiatives, 379
- Reform, 230, 248
- Reform movement, 416
- Reformation, 186
- Reformed economic system, 416
- Reformed teaching of history, 675
- Refraction, 27
- Refrigeration, 218
- Refugee crisis, 160
- Refugees, 524, 525
- Regime change, 654
- Regional Defense Strategy, 513
- Reich, Charles, 257
- Reichstag election, 1933, 494
- Relative sizes of planets, 57
- Relativity, 670
- Relativity theory, 31
- Religion and culture, 483
- Religion and ethnicity, 483
- Religion and politics, 252
- Religious dogma, 192
- Rembrandt van Rijn, 189
- Renaissance, 17
- Renewable energy, 269
- Renewable energy infrastructure, 560
- Renewables cheaper than fossil fuels, 564, 567
- Rents, agricultural, 260
- Replacement orders, 304
- Replanting forests, 379
- Reprocessing, 505
- Reprocessing fuel rods, 537
- Reproduction, 320, 323
- Reptiles, 69
- Reserves of uranium, 537
- Resource curse, 576
- Resource wars, 521, 678
- Resource-extracting firms, 577
- Resources, 361
- Resources per capita, 163
- Respect for the environment, 160
- Respiratory metabolism, 100, 107
- Responsibility for the future, 668
- Responsibility towards future generations, 594
- Restricting air travel, 579
- Restriction enzymes, 90
- Restriction maps, 90
- Retailing, 304
- Revenge and counter-revenge, 502, 531, 540
- Revolutions in outlook and lifestyles, 592
- Rhinoceroses, 123
- Ribonucleic acid, 85
- Ribosomal RNA sequences, 107
- Ribosomes, 86, 100
- Ricardo, David, 212, 214, 226, 235, 260
- Rice cultivation, 150
- Rice cultivation in Asia, 153
- Richard Dawkins, 484
- Right to life, 661
- Right-wing parties, 494
- Righteousness, 475
- Rights of children, 412
- Rights of man, 193
- Rights of Mother Earth, 389, 667
- Rights of the Child, 660
- Rights of Women, 412
- Rio Earth Summit, 585
- Rising death rates, 377
- Risk to human civilization, 588
- Ritual scarification, 480
- Rituals, 483
- River of money, 500
- RNA, 85, 86, 311, 322
- RNA and ribosomes, 85
- RNA polymerase, 86
- RNA world, 99, 322
- Robber barons, 238
- Robock, A., 506
- Robots, 303, 306
- Rochdale Pioneers, 233
- Rockefeller Foundation, 164

- Rockefeller Institute, 82, 86
 Rocket timeline, 349
 Rockets used in warfare in China, 349
 Rohrer, Heinrich, 313
 Rolls Royce Ltd., 303
 Roman Catholic Church, 494
 Rooftop solar installations, 565
 Roosevelt, Franklin D., 262, 263, 268, 560
 Rosenbluth, Arturo, 289
 Rotblat, Sir Joseph, 386
 Roumania bans fracking, 573
 Round Table Conference, 252
 Rousseau, Jean Jacques, 193
 Route down the Pacific coast, 155
 Roux, Emil, 435, 436, 439
 Roy, Arundhati, 521
 Royal Institution, London, 84
 Royal Society, 28, 204, 282, 434
 Rudolph II, 22
 Rules have to be changed, 582
 Run-off of water, 379
 Rural economy, 250
 Ruskin, John, 249
 Russell, Michael J., 103
 Russell-Einstein Manifesto, 385
 Russia, 489, 505, 513, 535
 Russia's reserves of oil and gas, 572
 Russian Arctic oil production, 572
 Russian petroleum industry, 572
 Russian Revolution, 242
 Rybozymes, 322

 S-type pneumococci, 82
 Saber-toothed cats, 123
 Sacgahero Hata, 446
 Sacred duty, 475
 Saddam Hussein, 510
 Saddam Hussien's atrocities, 484
 Safe water, 523
 Sagan, Carl, 98
 Sahara desert, 378
 Sahel, 167, 378, 379
 Saint Francis, 632
 Saint Paul, 624, 631
 Sale of African land, 420
 Salination, 164
 Salt march, 251
 Salt tax, 251
 Samos, 14
 San Thiago, 76
 Sand dunes near Beijing, 377
 Sanger, Frederick, 84, 92, 100
 Sanitary water supply, 522
 Sanitation, 411, 415
 Sanskrit, 182
 Sarah, Duchess of Marlborough, 192
 Satellite communication, 306
 Saturn, 57
 Saturn's rings, 359
 Satyagraha, 249
 Saudi Arabia, 559, 576
 Saudi Arabia and photovoltaics, 565
 Savery, Thomas, 204
 Saving the future, 582, 591, 592
 Savo, Mario, 257
 Say's Law, 244, 256, 267
 Say, Jean-Baptiste, 267
 Sayings of Buddha, 608
 Sayings of Confucius, 613
 Sayings of Lau Tzu, 618
 Scalar product, 318
 Scandinavia, 150, 559
 Scanning tunneling microscope, 313
 Scattered disc, 57
 Scattering of light, 44
 Schöffer, Peter, 186
 Scheele, Karl W., 222
 Scheraga, Herald, 303
 Schimper, Andrias, 106
 Schneider, Alfred, 106
 Scholar-gentry class, 176
 Schoolstrike for climate action, 584
 Schooners, 238
 Schrödinger, Erwin, 289, 302
 Science means nothing to politicians, 582
 Science of Ecology, 382

- Scientific developments from printing, 160
 Scientific method, 192
 Scotland, 218
 Sea anemonies, 122
 Sea level rise, 160, 163, 578
 Search for life's meaning, 640
 Second Industrial Revolution, 305
 Second law of thermodynamics, 677
 Secure jobs, 269
 Security Council, 511, 656
 Sedgwick, Adam, 73
 Sedimentary rocks, 71
 Seed-bearing plants on land, 122
 Seed-plands diversify, 122
 Seizing land from local people, 371
 Selection, 320, 327
 Selective breeding, 92
 Self, Steven, 137
 Self-assembly, 311, 312
 Self-defense, 654
 Self-destruction, 476
 Self-organization, 311
 Self-pollination, 80
 Self-reinforcing accumulation, 309
 Self-reliance, 250
 Self-reproducing automaton, 326
 Self-sacrificing courage, 475
 Self-sufficiency, 251
 Self-sufficient economy, 422
 Selfish motives, 476
 Semiconductors, 296
 Semiotics, 291, 324
 Sensation, 293
 Sensors, 304
 Sequencing methods, 84
 Sermon on the Mount, 626
 Service sector, 269
 Seven Deadly Sins, 625, 671
 Several hundred million deaths, 502, 532
 Severe droughts, 509, 530
 Severe hurricanes, 587
 Sewage, 210, 225
 Sexual reproduction, 121, 133
 Shamanism, 147, 479
 Shanidar, 150
 Shannon, Claude, 289
 Shapiro, J.A., 110
 Shark's teeth, 70
 Shaw, Pamela, 269
 Sheep domesticated, 152
 Shelley, Percy Bysshe, 198
 Shells, 70
 Shelly, Mary, 198
 Shih Huang Ti, 617
 Shiver, 475
 Shockley, William, 295, 296
 Short-term political advantage, 586
 Siberia, 479
 Siberia-Alaska land bridge, 138
 Siberian Traps, 578
 Sickle-cell anemia, 85
 Side chains, 444
 Side groups, 84
 Sierra Club, 381
 Sign systems, 291
 Silicon, 44, 296
 Silicon Valley, 296
 Simiens, 569
 Simulated evolution, 310
Sinanthropus pekinensis, 124, 125
 Single-stranded DNA, 83
 Singularity, 41
 Siphon, 204
 SIPRI, 514
 SIPRI Yearbook, 2017, 517
 Sir Joseph Rotblat, 386
 Sixth mass extinction, 580
 Sixth-order polynomials, 282
 Size of the Universe, 40
 Sizes of the planets, 57
 Sjostak, Jack, 99
 Skhul and Qafzeh, 137
 Slashing and burning, 372
 Slater, J.C., 303
 Slave laborers, 492
 Slave trade, 659

- Slave-like conditions, 243
- Slave-like working conditions, 209
- Slavery, 411, 416
- Slaves, 213
- Sleeping on three chairs, 294
- Sleeping sickness, 444
- Slime molds, 108, 325
- Sloth, 625, 671
- Small arms, 511
- Small arms, 639 million, 511
- Smallpox, 431, 663
- Smith, Adam, 206, 223, 243, 260, 261, 268, 678
- Smith, Dan, 517
- Smith, Hamilton, 90
- Smithsonian Institution, 233
- Snowden, Edward, 653
- Soap and palm oil, 372
- Social change, 670
- Social communication, 289
- Social competition, 247, 256
- Social competition with material goods, 678
- Social conscience, 416, 465, 592
- Social contract, 190
- Social Democrats, 494
- Social disruption by war, 523
- Social distancing, 458
- Social games, 580
- Social goals, 251
- Social impact of change, 203, 217
- Social interactions, 307
- Social legislation, 214, 235
- Social mobility, 176
- Social reform, 230, 248
- Social science, 190
- Social status, 245, 247
- Socially beneficial projects, 306
- Sociobiology, 484
- Sociology, 190, 244
- Socrates, 620
- Soft drink industry, 222
- Softening ethnic boundaries, 484
- Software, 309, 310, 320
- Soho, 294
- Soho manufactory, 207, 208, 221
- Soil conservation, 269
- Soil erosion, 164, 377, 379
- Solar energy, 593
- Solar Foundation, 570
- Solar Jobs Census, 570
- Solar panel prices, 565
- Solar panels on new houses, 565
- Solar System, 57
- Solar System's mass, 57
- Solidarity, not sanctions, 464
- Solutrian, 125, 127, 147
- Soma, 315
- Somalia, 510, 511
- Somerset, Edward, 204
- Sonora 64, 164
- Sonya Bers, 639
- Sophists, 620
- Sound, 29
- South Africa, 248, 252
- South Africa's nuclear weapons, 537, 538
- Southeast Asia, 370
- Southern Africa, 164
- Southern Asia, 164
- Southwest Asia, 513
- Sovereign states, 525
- Soviet un-manned rocket Luna 2, 355
- Soviet-style revolution, 494
- Space exploration, 298, 349
- Space race, 355
- Space telescopes, 670
- Space-time, 41
- Space-time symmetry, 32
- Spain, 310, 635
- Spain bans fracking, 573
- Sparta, 621
- Spatial complementarity, 444
- Speak out in clear language, 583
- Special relativity, 32
- Special theory of relativity, 32
- Species, 480
- Specificity, 444

- Spectrum, 27
- Speed of computers, 298
- Speed of light, 296, 312
- Sperm cells, 81
- Spiegelman, S., 322, 329
- Spinning wheel, 249
- Spiritual influence, 500
- Split with chimpanzees, 123
- Sponge method, 213
- Sponges, 69, 109, 122
- Spontaneous generation, 436
- Spray-painting, 303
- Springtails, 122
- St. Petersburg, 242
- Stability of species, 77
- Stable transgenic lines, 92
- Staining cells, 444
- Staining of bacteria, 437
- Standard Model of cosmology, 39, 40
- Standard model of cosmology, 57
- Standardization, 304, 305
- Stanford University, 85, 381, 385
- Star-maps, 15
- Start primer, 93
- Starvation, 209, 225, 235, 511, 522, 524
- State of nature, 190
- State of the World, 656
- State-provided elderly care, 411, 415
- Stationary economy, 260
- Statistical mechanics, 327, 329
- Status symbols, 244
- Steady-State Economics, 678
- Steady-state economics, 261
- Steam engine, 206, 219
- Steam locomotive, 219
- Steam-powered pumps, 204
- Steamboats, 238
- Steel, 608
- Stella Nova, 20
- Stellar evolution, 40
- Stem cells, 92
- Steno, 70, 71
- Stensen, Niels, 70
- Steric complementarity, 445
- Stern Report, 167
- Stern Review, 570
- Stibitz, George R., 287
- Sticky ends, 91
- Stock market, 260
- Stockholm, 270
- Stockholm Convention, 364
- Stockmarket, 304
- Stoeckenius, Walter, 313
- Stone tools, 155
- Stonewarts, 122
- Stop primer, 93
- Stop Violence Against Women, 418
- Storage density, 299
- Strassburg, 186
- Strategic competition, 517
- Strecker synthesis, 95
- Strikes, 242
- Stromatolites, 104, 107
- Structure of proteins, 310
- Sub-Saharan Africa, 133
- Subcellular granules, 106
- Subcellular particles, 86
- Subduction, 57
- Subjugation, 190, 245
- Submarginal land, 164
- Submarine seepage waters, 103
- Submission, 473
- Subnational organizations, 538
- Subsidiarity, 653
- Suburbia, 244
- Subversion of democracy, 193
- Sudan, 510
- Sugar-phosphate backbone, 83
- Sugars, 98
- Suicide of children, 212
- Sumerian city of Susa, 173
- Sumerian civilization, 173
- Sumerian writing, 173
- Summer water supplies threatened, 160
- Sun's size, 14
- Sun-centered cosmology, 17

- Sunspot cycle, 57
Supercomputers, 670
Supermarkets, 304
Supernova, 40, 44
Superpower status, 513
Superstition, 213
Supply, 268
Supramolecular chemistry, 312
Supramolecular structures, 311
Surfs, 242
Survival, 477
Survival of civilization, 521
Susa, 173
Sustainability, 259–261, 269, 422
Sustainability crisis, 580
Sustainable development, 257
Svante Arrhenius, 579
Svante Thunberg, 579
Swadeshi movement, 250
Swaminathan, M.S., 164
Sweden, 535
Swifts, 122
Swimming pools, 244
Swiss Patent Office, 32
Switzerland bans fracking, 573
Symbiosis, 104, 107, 108
Synapses, 315
Synchrotron radiation, 312
Synthesis of heavy elements, 40
Synthesis of proteins, 86
Synthetic cellular systems, 99
Synthetic RNA, 86
Syphilis, 444
Syria, 510
Syriac, 633
Systema Naturae, 123
Szent-Györgyi, Albert, 303
Szilard, Leo, 289

T'ang dynasty, 183
Tables of quadratic functions, 282
Talking knots, 177
Tanks, 491

Taoism, 616
Tapirs, 123
Target sequence, 94
Targeted individuals, 521
Tartaric acid, 434
Tattoos, 483
Tatum, Edward, 85
Taxation, 269
Team-spirit, 476
Technical change, 670
Technical defects, 504, 534
Technological unemployment, 305
Technology, 203, 217
Tectonic plates, 57
Teeth in fish, 122
Telescope, 26, 28, 189
Television, 593
Temperature difference, 103
Temperature inversion, 508, 530
Temperature-luminosity diagram, 40
Template theory of immunity, 452
Templates, 83
Tepe Yahya, 173
Terawatts (TW), 563
Terminal transferase, 90
Terror birds, 123
Terrorism, 513
Terrorism, nuclear, 505
Textbooks for peasants, 639
Textiles, 231
Thales Group, 514
The Annihilation of Nature, 382
The Cassandra Conference, 382
The earth is our mother, 391
The Kingdom of God, 641
The nature of fire, 193
The Origin of Species, 80
The party is over, 592
The Population Bomb, 381
The Potato Eaters, 157
The rules have to be changed, 583, 592
The Silent Spring, 366
The Social Contract, 193

- The Ten Commandments, 607
 The Trojan Women, 623
 Theory of Adaptive Systems, 320
 Theory of Games, 290
 Theory of rents, 260
 Theory of the Leisure Class, 244
 Theosophists, 248
 Thermodynamics, 327, 329
 Thermohaline circulation, 578
 Thermonuclear bombs, 538
 Thermonuclear reactions, 540
 Thermonuclear war, 243, 471, 672
 Thermonuclear weapons, 476, 527, 647
 Thermus aquaticus, 93
 Thin films, 298
 Thioacid activation, 103
 Thirty Years War, 26
 Thirty Years' War, 491
 Thoreau, Henry David, 253
 Threat of nuclear war, 527
 Threat of population crash, 160
 Threat of use of force, 654
 Threats and costs of war, 521, 522
 Three sisters, 156
 Three-letter code, 86
 Threshing in early Egypt, 150
 Threshold, 315
 Threshold Logical Unity (TLU), 314
 Thunberg, Greta, 579, 582, 583, 592, 594
 Thunberg, Svante, 579
 Thymine, 83
 Thymus gland, 453
 Thyroid cancer, 535
 Thyssen family, 491
 Thyssen, August, 491
 Thyssen, Fritz, 491, 493, 494
 Thyssen-controlled bank, 493
 Tides, 30
 Tierra, 328, 330
 Tigris River, 173
 Timeline of cosmology, 41
 Timeline of life on earth, 121
 Tinbergen, Nikolaas, 473
 Tipping points, 560
 Tipping points and feedback, 578
 Tipping points, definition, 578
 TLU, 314, 315, 318
 Toba Catastrophe Theory, 137
 Tobacco mosaic virus, 311
 Tobin tax, 656, 673
 Tobin, James, 656, 673
 Tokyo, firebombing, 502, 532
 Toledo, 638
 Tolstoy, 639
 Tolstoy and Gandhi, 641
 Tolstoy Farm, 249
 Tolstoy, Leo, 249, 253
 Tom Cruse, 518
 Toolmaking, 129, 147
 Toon, O., 506
 Toothed diving birds, 122
 Top Gun, 518
 Topsoil loss, 163, 164
 Torricelli, Evangelista, 203
 Torture, 212
 Total global supremacy, 513
 Total internal reflection, 302
 Totnes, Devon, England, 422
 Trade, 218
 Trade unions, 230, 233, 243, 267, 494
 Trading with the enemy, 492
 Training algorithms, 319
 Traitorous eight, 296
 Transfer RNA, 86
 Transgenic animals, 92
 Transgenic organisms, 92
 Transgenic plants, 321
 Transistors, 298, 309
 Transistors, invention of, 295
 Transition to 100% renewable energy, 561
 Transition to 100%renewables, 567
 Transition Towns, 422
 Transmission infrastructure, 565
 Transmutation of Species, 78
 Transportation, 244, 304
 Treaty for the Renunciation of War, 654

- Treaty of Versailles, 494
Tree sloths, 123
Tree-killing spree, 372
Tree-cutting for firewood, 378
Trees, destruction of, 167
Trench warfare, 476
Triassic-Jurassic Extinction, 578
Tribal markings, 479, 480
Tribalism, 476, 477, 603
Trigonometry, 15, 608
Triple Alliance, 489
Triple Entente, 489
Tropical diseases, 656
Tropical rain forests, 164, 261
True-breeding plants, 80
Trump's threats, 471
Trump, Donald, 517, 559, 591
Truth, 249, 252
Tsai Lun, 178
TTAPS Study, 508, 530
Tuberculosis, 437
Tubes sometimes failed, 294
Tumor-inducing plasmid, 92
Turco, R., 506
Turgot, 192
Turing, Alan, 287, 322
Turkey, 167, 431
Turtles, 122
Tuskegee Institute, 241
Two billion risk starvation, 510
Two-dimensional template, 312
Two-layer network, 319
Tycho Brahe, 19
Tycho's death, 25
Tycho's nose, 20
Tyrannical government, 190

U-235, 536
U-238, 536, 537
U-boats, 491
Uexküll, Jakob von, 291
Ukraine, 535
Ulam, Stanislaw, 323

Ultracentrifuges, 662
Ultracentrifugation, 83
Ultracentrifuges, 537, 538
Ultraminiaturization, 312
Ultraviolet light, 44, 291
Ultraviolet radiation, 95
Ultraviolet spectroscopy, 83
Umwelt, 291
UN Development Programme, 674
UN General Assembly, 502, 504, 532, 533
UN Secretary General, 656
UN Security Council, 511
UN television station, 656
UN's Agenda 2030, 517
Unauthorized act, 505
Undemocratic government, 576
Underhill, Peter, 134
Undernourished: 1.5 billion people, 160
Understatement of Existential Climate Risk, 585
Unemployment, 261, 262, 306
Unenriched uranium, 527
UNESCO, 655, 674
Unfair competition, 416
UNICEF, 418, 465
Unicellular eukaryotes, 109
Uniformitarianism, 71
Union of Concerned Scientists, 370, 591
Union of human souls, 642
Unions, 213, 230
United Kingdom, 489, 513
United Nations Charter, 464, 525, 540, 654
United Nations Framework Convention, 585
United States, 163, 164, 420, 489, 505, 513
United States Constitution, 650, 672
United States Steel, 241
United Technologies, 514
Universal computer, 287
Universal Declaration of Human Rights, 659
Universal education, 201
Universal human brotherhood, 484
Universal language, 176
Universal phylogenetic tree, 100

- Universal primary health care, 377
- Universal product code, 304
- Universal programmable computer, 283
- Universal Turing machine, 322, 323, 326
- Universality of religion, 483
- University of Krakow, 17
- University of Oxford, 193
- University of Paris, 70
- Unlimited economic growth, 678
- Unprecedented changes, 583
- Unprecedented investment opportunity, 567
- Unspeakable working conditions, 416
- Unto This Last, 249
- Unwarranted influence, 500
- Upper mantle, 57
- Upper Paleolithic technology, 138
- Upright locomotion, 125
- Uranienborg, 20
- Uranium, 536
- Uranium enrichment, 538
- Uranium reserves, 537
- Uranium-235, 527
- Uranus, 57
- Urban sprawl, 244
- Urbanization, 164
- Urey, Harald, 95
- US Department of Energy, 573
- US sanctions, 464
- USSR, 167
- Utilitarians, 213
- Utopian communities, 249
- Utopian socialists, 230

- Vaccination, 411, 431, 432, 439, 608
- Vaccination against rabies, 442
- Vaccine, 431
- Vacuum, 203
- Vacuum tubes, 287
- Vacuum tubes required cooling, 294
- Valence bands, 295
- Value systems, 483
- Van der Waals forces, 311
- Van Gogh, Vincent, 157
- Van Vleck, J.H., 303
- Vanderbilt University, 155, 238
- Vanderbilt, Cornelius, 238
- Vanderbilt, William, 238
- Varro, 437
- Vast proportions, 500
- Vauxhall House, 204
- Veblen, Thorstein, 244
- Vegetarians, 248
- Veils, 483
- Venezuela, 576
- Venezuela's Belt of Tar, 573
- Venus, 57
- Vermeer, Jan, 189
- Versailles Treaty, 266
- Verses from the Quran, 635
- Vestas, 569
- Vested-interest pressure, 587
- Vestigial organs, 71
- Veto power, 656
- Viceroy Lord Irwin, 251
- Vicious circle, 494
- Viet Nam, 160
- Vietnam, 526
- Vietnam War, 256
- Village life, 249
- Village solar installations, 566
- Village wind turbines, 566
- Villages of Cooperation, 232
- Violence, 245, 641
- Violence on television, 476
- Violent death, 524
- Violent team sports, 476
- Virchow, Rudolf, 123
- Virtual earth, 328
- Viruses, 442
- Visual cortex, 319
- Visual purple, 110
- Vitamin B12, 84
- Volcanic eruptions in Siberia, 578
- Volcanic islands, 77
- Volcanism, 57, 95
- Voltaire, 30, 190, 192

- Voltaire Foundation, 193
Volvo bans petroleum driven cars, 567
Votes for women, 412
Voting system of the UN, 674
Voyage of the Beagle, 78
Vries, Hugo de, 81
- W.D. Hamilton, 484
Wächthäuser, Günther, 103
Wade, Lizzie, 155
Wafers, 298
Wagari Maathai, 379
Waggle dance, 291
Wakefield, Gilbert, 198
Wakefield, Pricilla, 198
Walden, 253, 254
Wales, 535
Wallace, Alfred Russell, 70, 79
Wampum, 177
War, 242, 264, 420, 511, 642, 661
War and Christianity, 641
War and Peace, 640
War as an institution, 500
War crimes, 658, 665
War is based on destruction, 677
War to end war, 654
Wars manufactured to sell weapons, 521
Wars of religion, 483
Washington Naval Treaty, 489
Water, 95, 311
Water availability, 167
Water closets, 210
Water purification facilities, 525
Water supplies, 164
Water tables falling, 163
Water, rapid run-off, 379
Waterborne diseases, 415
Watering-down scientific findings, 587
Watson, James, 83
Watson-Crick model, 83, 323
Watt, James, 206, 207, 218, 219
Watts, 563
Watzelrode, Lucas, 17
- Wave equation, 302
Wave of depolarization, 315
Wave theory of light, 30
We have the facts and solutions, 581
We have to change, 580
We must love and forgive our enemies, 676
We Were Soldiers, 518
Wealth, 247
Weapon-making, 147
Weapons of mass destruction, 476
Weapons-usable materials, 537, 539
Weapons-usable Pu-239, 537
Weapons-usable uranium, 662
Wedgwood, Emma, 78
Wedgwood, Josiah, 73, 75, 78, 221, 222
Weight of the atmosphere, 204
Weight vector, 318
Well-paid work, 201
West African monsoon failure, 420
West African monsoon loss, 578
Western Eurasia, 133, 134
Western Europe, 513
Whales, 69
What is law?, 603
What Lies Beneath, 585
Wheat farms, 167
Wheat varieties, 164
Wheeler, John A., 536
Wheels within wheels, 15, 17
Whistleblowers punished, 651
White dwarfs, 40
White light, 27
Wholesaling, 304
Why the earth is important, 669
Why wasn't it made illegal?, 580
Why were there no restrictions?, 580
Wide-spread famine, 160
Wiener, Norbert, 287, 289, 293
Wild grains, 152
Wildlife reserves in Cyberspace, 329
Wilkins, Maurice, 83
Wilkinson, John, 208
Willadsen, Steen, 321

- Wilson, E. Bright, 303
 Wilson, E.O., 477, 484
 Wilson, Robert Woodrow, 39
 Wind energy, 565, 593
 Wind energy, rate of growth, 564
 Wind erosion, 167
 Wind farm's footprint, 566
 Wind turbine cooperatives, 569
 Wine industry, 436
 Winter heating of homes, 572
 Winter Palace, 242
 Wittenberg, 186
 Woese, Carl, 99, 100, 107
 Wolfowitz Doctrine, 513
 Wolfram, Steven, 324
 Wollstonecraft, Mary, 198
 Women in medicine, 412
 Women's right to vote, 412
 Woodblock printing, 182
 Wooden printing press, 186
 Woodpeckers, 122
 Word-processors, 305
 World arms spending, 522
 World Bank, 268
 World Economic Forum survey, 588
 World Health Organization, 414, 415, 457,
 522, 655, 656, 674
 World of Warcraft, 521
 World population, 235
 World Trade Center, 2001, 507
 World War I, 242, 264, 489, 491, 494, 654
 World War II, 243, 268, 491, 508, 525, 530,
 654, 672
 World Wide Web, 306
 World's oil reserves, 573
 World's poorest three billion, 589
 Worldwatch Institute, 269
 Wrath, 626, 671
 Wren, Sir Christopher, 28
 Writing, 173, 174, 176, 182, 309
 Writing in the Americas, 177
 Wuhan, China, 457
 Wurm glacial period, 147
 X-chromosomes, 133
 X-ray diffraction, 83, 302
 X-rays, 82, 312
 Y-Chromosomal Adam, 134
 Y-chromosomal DNA, 133
 Y-chromosomes, 133
 Yasnaya Polyana, 639
 Years remaining, 561
 Yongbion Research Center, 514
 York, Duke of, 232
 Zagros mountains, 150
 Zero, 608, 634
 Zettabytes, 308
 Zimbabwe, 511
 Zionism, 483
 Zona pelucida, 321
 Zoonomia, 72
 Zoophytes, 69
 Zuse, Konrad, 287